

CHANGE }
No. 1 }

Logistics

FM 700-80, 15 August 1985, is changed as follows:

1. New or revised material is indicated by a vertical bar in the margin. Where an entire chapter, section, or illustration is added or revised, the vertical bar is placed at the beginning of the section.
2. Remove old pages and insert new pages as follows:

<i>Remove pages</i>	<i>Insert pages</i>
1-5 and 1-6	1-5 and 1-6
2-1 through 2-7	2-1 through 2-7
3-1 through 3-4	3-1 through 3-4.1
3-7 and 3-8	3-7 and 3-8
4-11 through 4-17	4-11 through 4-17
5-11 through 5-20	5-11 through 5-21
6-1 through 6-6	6-1 through 6-6
7-3 through 7-6	7-3 through 7-6
8-1 through 8-4	8-1 through 8-4
9-5 through 9-11/9-12 blank	9-5 through 9-11
10-3 and 10-4	10-3 and 10-4
10-5 and 10-6	10-5 and 10-6.1
11-3 through 11-7	11-3 through 11-7
12-1 and 12-2	12-1 through 12-2.1
12-5 and 12-6	12-5 through 12-6.1
13-1 through 13-3/13-4 blank	13-1 through 13-3
14-1 and 14-2	14-1 and 14-2
15-1 and 15-2	15-1 and 15-3
16-1 and 16-2	16-1 and 16-2.1
18-1 and 18-2	18-1 and 18-2.1

3. File this transmittal sheet in front of the publication.

By Order of the Secretary of the Army:

Official:

WILLIAM J. MEEHAN II
Brigadier General, United States Army
The Adjutant General

CARL E. VUONO
General, United States Army
Chief of Staff

Distribution:

To be distributed in accordance with DA form 12-11A, (Block 0516) Requirements for Logistics.

FIELD MANUAL

No. 700-80

HEADQUARTERS
DEPARTMENT OF THE ARMY
WASHINGTON, DC, 15 August 1985**LOGISTICS**

		<i>Paragraph</i>	<i>Page</i>
PART ONE	INTRODUCTION		
CHAPTER	1. THE ARMY LOGISTICS SYSTEM		
Section	I. Purpose and Scope of Manual	1-1 — 1-5	1-1
	II. Introduction to Army Logistics	1-6 — 1-12	1-2
	III. Logistics Principles	1-13 — 1-16	1-8
CHAPTER	2. ORGANIZATION FOR LOGISTICS		
Section	I. Military Command Structure	2-1 — 2-6	2-1
	II. Organizations External to the Army Which Support the Army	2-7	2-4
	III. Department of the Army Organiza- tion for Logistics	2-8 — 2-9	2-5
CHAPTER	3. ARMY LOGISTICS REQUIREMENTS AND RESOURCE MANAGEMENT	3-1 — 3-12	3-1
PART TWO	JOINT STRATEGIC PLANNING SYSTEM		
CHAPTER	4. PLANNING, PROGRAMING, AND BUDGETING		
Section.	I. Planning and Requirements	4-1 — 4-14	4-1
	II. Army Financial Management	4-15 — 4-28	4-10
CHAPTER	5. PLANNING LOGISTICS SUPPORT FOR MILITARY CONTINGENCY OPERATIONS		
Section	I. General	5-1 — 5-3	5-1
	II. Joint Planning	5-4 — 5-14	5-3
	III. Planning for Mobilization	5-15 — 5-17	5-15
	IV. Support of Civil Defense Disaster Relief and Civil Disturbance Control Operations	5-18 — 5-21	5-17
PART THREE	ACQUISITION FUNCTION		
CHAPTER	6. MATERIEL ACQUISITION		
Section.	I. Determining Materiel Requirements	6-1 — 6-8	6-1
	II. Research and Development, Test, and Evaluation (RDTE)	6-9 — 6-10	6-2
	III. Management Controls and Techniques	6-11 — 6-15	6-4
CHAPTER	7. CONTRACTING		
Section	I. General	7-1 — 7-6	7-1
	II. General Contracting Methods, Tools, and Techniques	7-7 — 7-12	7-3
CHAPTER	8. PRODUCTION		
Section	I. Production Resources and Capabilities	8-1 — 8-4	8-1
	II. Production Controls and Techniques	8-5 — 8-10	8-2
PART FOUR	SUPPLY		
CHAPTER	9. INVENTORY MANAGEMENT	9-1 — 9-29	9-1
CHAPTER	10. DISTRIBUTION MANAGEMENT		
Section	I. Objectives and Concepts	10-1 — 10-6	10-1
	II. Storage	10-7 — 10-8	10-3

* This manual supersedes FM 700-80, 15 September 1982

		<i>Paragraph</i>	<i>Page</i>
	III. Distribution of All Classes of Supply	10-9 — 10-17	10-4
	IV. The Direct Support System/Air Line of Communication	10-18 — 10-19	10-8
	V. The Military Standard Logistics Systems	10-20 — 10-21	10-9
PART FIVE	MAINTENANCE MANAGEMENT		
CHAPTER	11. MAINTENANCE MANAGEMENT		
Section	I. Introduction	11-1 — 11-4	11-1
	II. Maintenance Engineering	11-5 — 11-9	11-1
	III. Material Maintenance Operations Management	11-10 — 11-15	11-3
Section	IV. Maintenance Information Management	11-16 — 11-18	11-5
PART SIX	TRANSPORTATION		
CHAPTER	12. MANAGEMENT OF TRANSPORTATION OPERATIONS		
Section	I. Transportation System Organizations and Activities	12-1 — 12-8	12-1
	II. Transportation Services in a Theater of Operations	12-9 — 12-12	12-6
	III. Transportation Mode and Terminal Operations in a Theater of Operations	12-13 — 12-14	12-9
	IV. Movements Management in a Theater of Operations	12-15 — 12-19	12-11
PART SEVEN	SERVICES		
CHAPTER	13. SERVICES MANAGEMENT		
Section	I. Army Food Program	13-1 — 13-3	13-1
	II. Other Support Services	13-4 — 13-9	13-2
PART EIGHT	FACILITIES		
CHAPTER	14. FACILITIES MANAGEMENT		
Section	I. Real Property Program Management	14-1 — 14-6	14-1
	II. Real Property Maintenance Activities Program	14-7 — 14-9	14-2
PART NINE	OTHER LOGISTICS SERVICES		
CHAPTER	15. SECURITY ASSISTANCE	15-1 — 15-4	15-1
	16. MANAGEMENT OF EXCESS AND SURPLUS PROPERTY		
Section	I. The Defense Materiel Utilization Program	16-1 — 16-7	16-1
	II. Transfer of Excess Property	16-8 — 16-9	16-3
CHAPTER	17. MEDICAL LOGISTICS		
Section	I. Introduction	17-1	17-1
	II. Theater of Operation	17-2 — 17-4	17-1
	III. CONUS	17-5 — 17-6	17-3
CHAPTER	18. AUTOMATED LOGISTICS MANAGEMENT INFORMATION SYSTEMS		
Section	I. Introduction	18-1	18-1
	II. The Standard Army Logistics System	18-2 — 18-6	18-1
	III. The SAILS Subsystem	18-7 — 18-9	18-4
INDEX			Index-1

PART ONE: INTRODUCTION

CHAPTER 1

THE ARMY LOGISTICS SYSTEM

Section 1. PURPOSE AND SCOPE OF MANUAL

1-1. Purpose

a. The purpose of this manual is to provide a reference on Army logistics management doctrine. It is intended for use as a reference by commanders, staff officers, and logistics operating personnel, including those responsible for training, operations, materiel readiness, and materiel development; national inventory control points (NICPs); service item control centers (SICCs), agencies and activities; and higher levels. This manual may be used for the development of supporting doctrinal or training literature for use below major command level and as a text in advanced courses of instruction in the Army school system. This manual provides logistics guidance for commanders and logistics staff officers of the organizational levels stated above in the same vein that field manuals (FMs) of the 100 series provide guidance to the major tactical commanders and operations staff officers on how to fight.

b. The objectives of this manual are to —

- (1) Help develop an understanding of the concept of logistics;
- (2) Show the functional components of the Army Logistics System;
- (3) Highlight the roles of principles and performance analysis in the design of the Army Logistics System;
- (4) Show the activities of the logistics system in relation to various aspects of the external and internal environments of the Army; and
- (5) Emphasize the interdependence of the subsystems of the Army Logistics System.

1-2. Scope

a. This manual provides a discussion of the general philosophies, principles, concepts, and organizational considerations of managing the overall system, to include basic system elements, functions, subfunctions, and processes performed in support of the soldier. Important considerations relative to systems needs are personnel, materiel, facilities, and services; how they are acquired and distributed to those who need and will use them; how they are maintained; and when no longer needed, how they are replaced and removed from the system. This manual also discusses management within the various levels and segments of the system from Headquarters, Department of the Army (HQDA) level through wholesale, intermediate, and

direct support/user levels. The interrelationships and interfaces of the basic elements, the functions and processes, and organizational aspects within the Army system together with those external systems of Department of Defense (DOD) and other U.S. Government agencies which support the Army, are treated to show how logistics support is furnished. While emphasis is placed on logistics management at major command and higher level, sufficient discussion of management at the intermediate and direct support/user levels is included to provide a basis for understanding the relationships and interworkings of managing the whole system. For this reason, details of specific functions, procedural, and organizational aspects of logistics are not discussed. These will be discussed in initial and secondary supporting manuals of the 700 series and other manuals of the 54, 55, and 100 series.

b. The language used in certain portions of this manual is not intended to discriminate on the basis of sex, where the words "he" or "she" appear; they are intended to include both the masculine and feminine genders.

1-3. Organization of Manual

a. The manual is constructed in nine parts. Each part focuses on a particular aspect of logistics. Together they encompass background information, logistics principles and policies, functional and organizational structures, logistics processes, management techniques, and key systems relative to overall management, accountability, and responsibility.

b. Part 2 describes the Joint Strategic Planning System (JSPS); the Army Planning System in implementation of JSPS; the DOD Planning, Programming, and Budgeting System (PPBS); and processes in relation to JSPS and how the Army develops input into the DOD PPBS. Included as part of JSPS are the planning functions for development of military plans to support national objectives.

c. Management of elements of the Army Logistics System (acquisition, supply, maintenance, transportation, services, and facilities) are discussed in parts 3 through 8.

d. The management of three other logistics operations which influence Army operations (security as-

sistance, excess property, and health services) are covered in part 9.

e. Part 9 (chapter 18) discusses the use of automated techniques and outlines information that is needed to manage the Army Logistics System and techniques for managing the information, as well as a summary of information systems currently in use or planned for use in the near future.

1-4. References

a. References are provided throughout to aid in further reading and research.

b. Terminology and definitions used in this manual conform to Joint Chiefs of Staff Publication (JCS Pub)

1, Dictionary of Military and Associated Terms, and AR 310-25, Dictionary of United States Army Terms.

1-5. Changes

Users of this manual are encouraged to recommend changes and submit comments for its improvement. Comments should be keyed to specific page, paragraph, and line of the text in which the change is recommended. Reasons should be provided for each comment to insure understanding and complete evaluation. DA Form 2028 (Recommended Changes to Publications) should be used and forwarded directly to the Commandant, U.S. Army Logistics Management Center, ATTN: AMXMC-LS, Fort Lee, VA 23801-6040.

Section II. INTRODUCTION TO ARMY LOGISTICS

1-6. General

a. To quote from Dr. James A. Huston, *The Sinews of War: Army Logistics 1775-953*: "Logistics is the application of time and space factors to war. It is the economics of warfare, and it comprises, in the broadest sense, the three big M's of warfare-materiel, movement, and maintenance. If international politics is the 'art of the possible,' and war is its instrument, logistics is the art of defining and extending the possible. It provides the substance that physically permits an army to live and move and have its being."

b. Viewed in its broadest context, logistics is the art and science of creating and maintaining a military capability. Its purpose is to create weapons and forces and provide sustained support of these weapons and forces in combat. JCS Pub 1 defines logistics as, "The science of planning and carrying out the movement and maintenance of forces. In its most comprehensive sense, those aspects of military operations which deal with:

"(1) Design and development, acquisition, storage, movement, distribution, maintenance evacuation, and disposition of materiel.

"(2) Movement, evacuation, and hospitalization of personnel.

"(3) Acquisition or construction, maintenance, operation, and disposition of facilities.

"(4) Acquisition or furnishing of services."

c. Army logistics is influenced by a wide range of multilayered, external forces. Within the realm of military activities, logistics is bound to strategy and tactics. Military activities function in an environment which is driven by national objectives and policies and is shaped primarily by socioeconomic and political factors. These relationships are shown in figure 1-1. The model in figure 1-1 accomplishes a number of things. It extends the traditional Army treatment of military

logistics by putting it in a systems context. It represents a combination of management theory with military relationships. It provides a broader understanding of the forces which affect logistics policy.

d. Logistics contributions encompass the means to equip and sustain the Army in its role to support U.S. national policy and military strategy. The Army's role is to provide general-purpose forces to meet any threat to U.S. national security. The ultimate objective of Army logistics is the enhance national security by providing the necessary weapons/equipment systems which are reliable, supportable, in a high state of readiness, and are technologically superior to those of our potential adversaries. It must also provide a balance of logistics force structure, supplies, equipment, facilities, and services for adequate sustainability of combat forces to insure success of the combat mission.

1-7. U.S. Army Contributions to National Security

a. The national command authorities (the President and the Secretary of Defense) and other members of the National Military Command Structure are responsible for carrying out the national security mission in an effective, efficient, and responsive manner. U.S. national security strategy is concerned with future events, conditions, and circumstances which may pose a threat to U.S. national objectives or national security. In such cases, U.S. military forces may need to be employed to reduce the threat. Should one of these events or conditions occur, and military forces are used, the military effort will be carried out by one or more of the unified or specified commands under the control of the Joint Chiefs of Staff (JCS) in behalf of the national command authorities. All the military services support the operations of these commands by provid-

ARMY LOGISTICS ENVIRONMENT

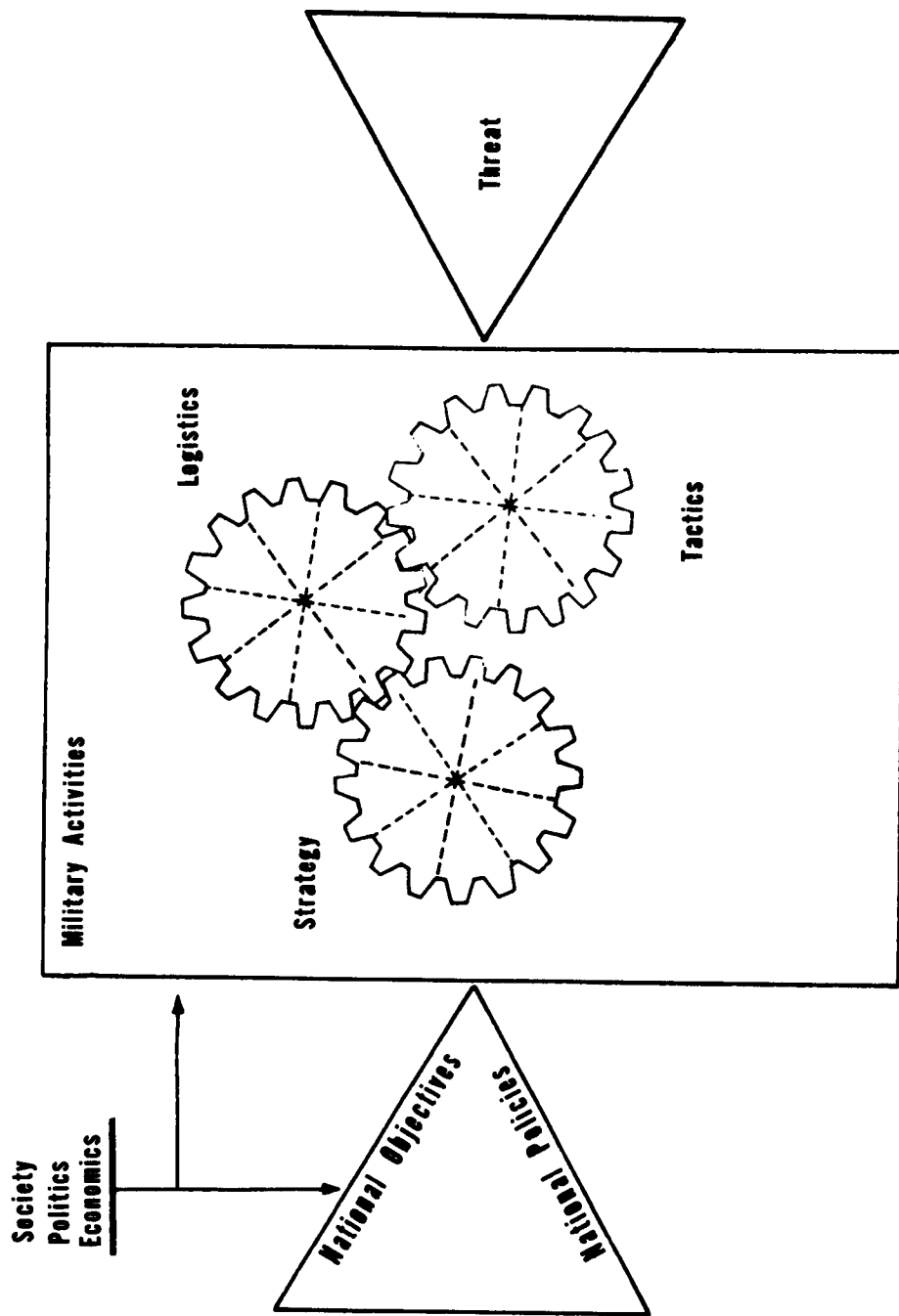

- Key:**
- Circles represent parts of the system.
 - Dotted lines represent internal interactions.
 - Solid lines represent external interactions.
 - All lines are elastic.

Figure 1-1.

ing units which are organized, equipped, and trained to fight and win. The specific contingencies which may arise are difficult to predict. However, analysis of all possible threats and other factors cause the national command authorities to identify several contingencies in different parts of the world with enough likelihood of occurring to warrant developing operations plans (OPLANs) for the conduct of operations. The OPLANs developed by JCS and the unified and specified commanders, together with the policies and goals they are intended to carry out, are the basis for development of objectives and goals by DOD and each service.

b. Supporting goals are developed by the Secretary of the Army and Chief of Staff of the Army to direct the Army's efforts toward accomplishment of DOD and national goals. These goals provide fundamental direction for the total Army (Active Army, Army Reserve, Army National Guard, and Army civilian employees) to channel their resources and efforts. Within the total Army goals are many logistics implications from which Army logistics managers derive supporting goals and objectives. These become a basis for actions, a focal point for efforts, and a foundation for plans.

1-8. The Army Logistics Mission

a. The basic mission of the Army Logistics System is to support the soldier in the field with what is needed, when, where, and in the condition and quantity required at minimum expenditure of resources. This mission is the common thread which connects all logistics activity, governs application of principles, and establishes a framework of fundamental logistics principles which guide mission accomplishment.

b. The logistics mission is derived from DOD programs. Essentially, the logistics objective of the Army is to maintain a logistics posture tailored to support the required peace and war operational requirements. The desired end product of the mission is the integration of allocated resources by efficient and effective management and operations to accomplish the Army logistics objective within imposed constraints.

1-9. The Systems Approach to Logistics

a. A system is defined as an array of components designed to accomplish a particular objective according to plan. The systems theory includes the systems philosophy (a way of thinking); systems management (the integration of operations through design of the organization and the relationships of its parts); and systems analysis (efficient use of resources to achieve objectives).

b. The first element in systems theory is to develop a systems philosophy or a way of thinking about the

logistics system. A logistics system is defined as a "network of related procedures, homogeneous in character and similar in operational concepts, together with the supporting organizational authority structure and basic elements which are integrated into a total design structure to insure accomplishment of an organization's mission or predetermined objectives, according to plan."

c. Logistics is a major system consisting of a group of functional subsystems. Since activities within these subsystems have a tendency for excessive growth, it is necessary to exercise control over them. The most effective and efficient system is not the result of merely maximizing the effectiveness and efficiency of the performance of each of its subsystems, but is a balanced system capable of adjustment to meet changing priorities and needs. These characteristics must be understood by the logistician along with other principles of logistics so effective management effort can be applied. The logistics system must be viewed as a whole. Good management must permeate the entire military system. Through knowledge of logistics, we learn why we create weapons and forces and what to do to control them. Management knowledge provides the best ways to achieve this result and to control the activities within the system (see AR 5-1, Army Management Philosophy).

d. In applying this systems concept to the Army Logistics System, several points must be recognized. The system is manmade so it must be a planned, operational process, requiring mutual functioning of diverse parts under managerial control. The basic elements of the system include the support and test equipment, facilities, personnel, technical and management data, computer programs, and funding required to operate the system. These elements, in turn, provide the materiel, facilities, and services to organize, train, and equip Army forces for prompt and sustained land combat. In operation, the system must perform several processes including the determination of what materiel, facilities, and services are needed to support the soldier and the weapons/equipment systems; how they are acquired and distributed to those who need and will use them; how they are maintained in operation; and, when no longer needed, how they are purged from the system.

e. In this concept, the following definitions of the processes apply:

(1) *Requirements Determination.* A requirement is an established need justifying the timely allocation of resources to achieve a capability to accomplish an approved military objective, mission, or task. A requirements determination is a statement of need, together with the definition of the resources necessary

to accomplish the stated need.

(2) *Acquisition.* The acquisition process consists of all of those tasks performed to satisfy the quantitative, qualitative, and time specifications of the requirements process. The process is performed to acquire weapon systems or major end items needed to create and maintain a military capability. It included research and development, design and engineering, and those measures and procedures pertaining to acquisition of personnel, facilities, equipment, repair/spare parts, tools, support and test equipment, cataloging, and technical manuals required to develop, produce, emplace, operate, and maintain materiel. The acquisition process is directly related to the requirements process in that it must respond to the needs as specified by the requirements process. Satisfaction of a need through use of existing resources is not included in this definition of the acquisition process. In a broad sense, the acquisition process has three separate phases:

(a) The translation of the need from requirement terms to terms suitable for acquisition.

(b) The obtaining of what is needed by leasing, buying, recruiting, and constructing. The method usually involves the seeking of a source, the selection of a source, negotiation, and agreement.

(c) Acceptance and compensation for value received.

(3) *Distribution.* The distribution process involves all logistical aspects to move, receive, store, handle, and issue materiel in the Army supply system.

(4) *Maintenance.*

(a) Maintenance is the function of sustaining materiel (weapons systems, components, spares, support equipment) and facilities in an operational status; restoring them to a serviceable condition; or upgrading their functional utility through modification. It can be performed by organic capability or contract. DOD categorizes maintenance of materiel into two general groups:

1. *Direct Maintenance Support.* Maintenance performed on materiel while it remains under the custody of the using military commands. Upon restoration to serviceable condition, the materiel is normally returned directly to service.

2. *Indirect Maintenance Support.* Maintenance performed on materiel after its withdrawal from the custody of the using military command. Upon restoration to serviceable condition, the materiel is returned to stock for reissue or returned directly to the user under conditions authorized by

the military department concerned.

(b) DOD further classifies the total materiel maintenance function into four general levels of effort: (See also para 11-11.)

1. *Unit.* Unit maintenance is the maintenance for which the using organization is responsible and it is performed on assigned equipment. The phases normally consist of inspecting, servicing, lubricating, adjusting, and replacing parts, minor assemblies, and subassemblies.

2. *Direct Support Maintenance (DS).* Direct Support (DS) maintenance is performed in support of the user. It is characterized by forward orientation, repair by replacement, and provides mobile, responsive "one-stop" maintenance support.

3. *General Support (GS).* General Support maintenance is performed in support of the theater supply system. It is characterized by semi-fixed facilities with job or production line operations and located at echelons above corps.

4. *Depot.* This level of maintenance is oriented toward support of the supply system at both theater and national levels. Organizations are fixed or semi-fixed. Maintenance at this category will be primarily production line oriented and will be performed by selected commodity oriented organizations (both military and civilian), Specialized Repair Activities (SRAs), AMC depots, contract personnel, third country nationals, and host nation support. Maintenance capability will include overhaul, rebuild, modification, calibration, analytical, special and non-destructive testing/inspection, cannibalization, and fabrication of items not supported by the supply system in support of National Maintenance Point (NMP) requirements. This level of maintenance maintains and accounts for any Operational Readiness Float/Repair Cycle Float (ORF/RCF) not maintained by the Intermediate Level, all Prepositioned Materiel Configured to Unit Sets (POMCUS), and War Reserve stocks.

(c) The maintenance of facilities process includes the preventive and restorative measures necessary for the operation of real property and utility systems, minor construction, and engineering services.

(5) *Disposal.* The disposal process involves the purging (under proper authority) of excess, obsolete, or surplus materiel (weapons systems, components, spares, support equipment), supplies and real property (Government-owned and -leased installations and housing); making such items available to other prospective users; and effecting maximum possible recovery of value of items.

1-10. Management of the Army Logistics System

a. The integration of operations of the system through design, together with placing emphasis on the interrelationship of its parts, is the second element of the system theory—Systems Management. In the Army Logistics System, each of these processes requires management controls. Since they are interrelated, it is necessary to have logistics managers who know and understand all the components and subsystems which make up the system, their interfaces, and their interrelationships. This calls for management of the individual process which make up the system and management of the system as a whole.

b. Three main levels of management of the Army Logistics System may be considered. Each level views the system from a different perspective. At the highest level, the principal interest is in making program and budget decisions to accomplish long-range objectives. Further down the chain of command, the interest becomes aligned to the accomplishment of more specific tasks within narrow time frames. The logistics manager should appreciate how the system operates from top to bottom. The management of the logistics system might be better understood if one could visualize what happens in the logistics management process. This is illustrated in figure 1-2.

(1) Logistics objectives are attained and results produced through the operation of the logistics processes. The system inputs are the objectives, missions, and plans. These are constrained by policy, funds, time, technology, and many other factors. Then, as shown in the top portion of the model, the allocated resources and the objectives are translated into a program and assigned to an organization for accomplishment. This is the decisionmaking level of management. At this point, the process is identified with a mission/program.

(2) The output is a decision of what to do, when, where, and by whom. The lowest level takes the programs, allocated resources, and tasks produced by the highest level and performs work on them to consume the resources and produce an end product. In between these two levels are knowledgeable specialists who are experts in very narrow fields. They command very few subordinates; do not set policy, nor produce a salable product. They are the ones who made the day-to-day operating decisions. They conduct special interest studies and make recommendations on which top-level management bases its decisions. Collectively, these middle managers exert significant influence on the operation of the organization. Thus, the total Army

Logistics System is made up of a complex of subsystems, each of which operates on inputs to produce outputs.

1-11. Analysis of the System

The third element of the systems theory—systems analysis—or a systematic method of problem solving is a valuable vehicle to assist in the decision-making process. The analysis should determine the parameters within which the system should operate; describe the system in detail; and it should be unbiased and objective. The analysis should describe the objectives of the system (end product); its performance requirements (what must be done) to accomplish the objectives; external and internal constraints which will influence system performance, including the physical environment in which it must operate; policies and procedures prescribed by higher authority and other constraints. The analyst should describe functional interfaces such as preceding functions (those which must be accomplished before others can be initiated), succeeding functions (what happens when a function has been completed), and independent functions (those which can be accomplished simultaneously with other functions). Other factors in the description of the system include how performance is to be measured, required response times, and frequency of operation. After describing these characteristics of the system, it is necessary to determine the measures to satisfy the performance requirements and list all possible alternatives. The performance criteria against which the various alternatives are compared are determined and trade-offs or trade studies are completed. These are synthesized and subjected to various repetitive considerations until the solution which best accomplishes the objective is determined.

1-12. Functional Structure of the Army Logistics System

The basic functional structure of the Army Logistics System is described in AR 700-126. The five major functions are supply, maintenance, transportation, services, and facilities. This structure incorporates the processes of a logistics system discussed in paragraph 1-9, but is oriented more toward logistics functions of the Army in the field. Some functions, such as those relating to the design and development of materiel and the evacuation and hospitalization of personnel stated in the official DOD definition of logistics, are not easily identified or are missing from the Army basic functional structure of logistics. The processes of requirements determination, acquisition, production, test and evaluation, and fielding of new weapons/equipment

LOGISTIC MANAGEMENT PROCESSES

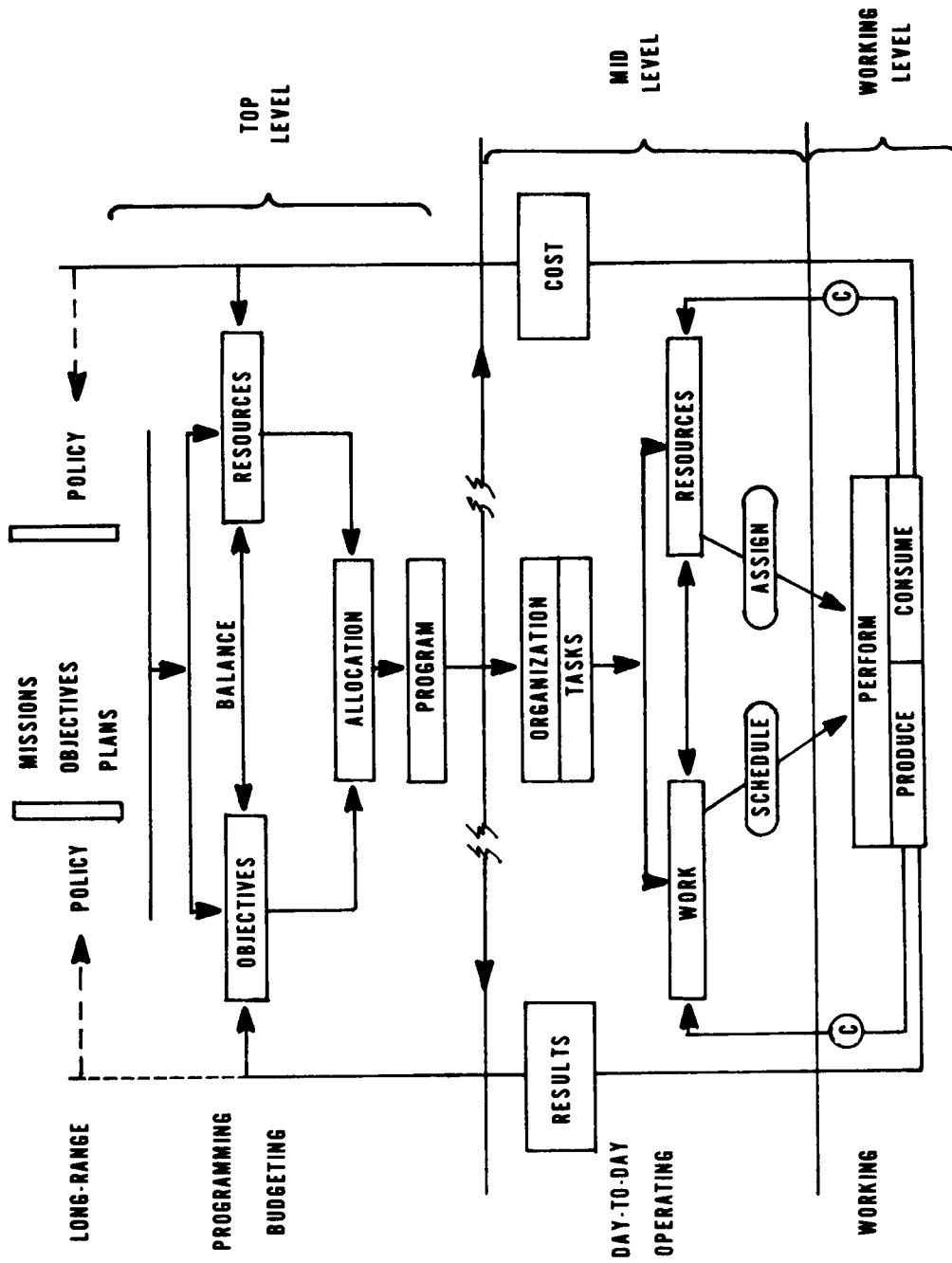

Figure 1-2.

systems as described in paragraph 1-9 are significantly different from similar type functions described under the function of supply of the Army Logistics System described in AR 700-126. The subfunctions and tasks listed in AR 700-126 indicate management of some parts of the logistics system at the midlevel and operational levels, but does not provide for top-level

management of the total Army Logistics System. A study of the assignment of responsibilities for managing logistics functions throughout the army reveals that no single officer on the DA Staff or that of a major command staff has responsibility for managing the total logistics system (see paragraph 2-9).

Section III. LOGISTICS PRINCIPLES

1-13. General

In this book, *Logistics in the National Defense*, Rear Admiral Henry E. Eccles, U.S. Navy (Ret), states several principles of logistics which must be understood by civilian and military leaders for successful employment of military forces to accomplish political objectives. "Logistics," says Admiral Eccles, "is the creation and sustained support of weapons and forces to be tactically employed to attain strategic objectives." He has further described logistics as being "a coherent process of two over-lapping phases"—producer and consumer. "The creation of weapons and forces is the producer phase. The sustained report of these weapons and forces is the consumer phase." Since these two phases exist, it is Admiral Eccles' view that logistics principles should be recognized as being different for each area and level of management.

a. Several principles of consumer logistics apply to the commander of a major theater, command or area, or major oversea operation. These are related to those major problems of a command such as control, strategy and tactics, communications, and intelligence. These principles involve the logistics system as a whole, i.e., the coordination of a variety of technical functions such as supply, maintenance, transportation, construction, and the furnishing of medical and support services. Other principles govern the effectiveness and efficiency of the technical functions or the subsystems of the logistics systems. Still others govern the performance of the production phase which involves the national military structure and broad features of the military acquisition process. Even within each of these components, there are principles which govern the various functional elements.

b. The logistics process is the bridge between the national economy and the tactical operations of the combat forces. The logistics system must be in agreement with the national economic system and with the tactical concepts and tactical environment of the combat forces. Therefore, logistics has a dual nature; it changes its nature as it moves from the field closest to the economy, which is producer logistics, and goes into the field which is closest to combat, which is consumer logistics.

c. The relationship between the operation of the military logistics system and the national economy is not always fully appreciated. This relationship can be seen in the following two examples:

(1) The location and operations of military installations and the functions of the military acquisition processes can create significant political and economic impacts.

(2) Excessive logistics support, i.e., introduction of the U.S. standard of living into the combat arena, nice-to-have or more support items than are required, contributes to unnecessary cost of supporting a force.

d. Since resources are always limited, commanders cannot expect to have all their requirements satisfied. To maximize readiness, a system of priorities and allocations is needed to distribute available resources. Commanders submit a statement of required resources to accomplish their missions. Based on the overall strategy and tactical concepts available, resources are then allocated to those commanders carrying out those missions.

e. To be effective and efficient, logistics does not necessarily have to be organized as a single system. However, good management must permeate the whole military system of which the logistics system is a part. Management is one of the tasks of command, not a substitute for command. The senior command has the responsibility to create, support, and employ combat forces. To carry out these responsibilities requires operational planning. This planning is an intimate blend of tactical and logistical thinking to accomplish the strategic objectives.

1-14. JCS Guidance for Logistics

Several basic principles have been developed by the JCS to provide guidance for commanders in their assignment of logistics responsibilities. Included are those to:

a. Promote combat efficiency of the armed services as a whole by prevention of unnecessary duplication of facilities, services, supplies, and equipment.

b. Design logistics systems for expansion to meet peak loads they will face in an emergency.

c. Be responsive to operational and technical requirements of commanders.

d. Avoid depriving operational units of essential support.

e. Provide for administrative control by one service where facilities are used jointly.

f. Provide for operational control of personnel.

1-15. Logistics Principles of the Department of the Army

a. To effectively manage elements of the Army Logistics System, the logistician must understand and apply certain fundamental principles of logistics. The Army principles of logistics are as follows:

(1) *Logistics intelligence*. Commanders must have accurate and timely logistics information in order to provide effective logistics support.

(2) *Objective*. Logistics endeavors must be directed toward a clear and attainable objective.

(3) *Generative logistics*. The professional application of initiative, knowledge, and ingenuity, and the innovative exploration of technical and scientific advances are fundamental to the generation of logistics systems improvements.

(4) *Interdependence*. Logistics system efficiency requires effective interrelationships among all functional parts of the system.

(5) *Simplicity*. Simplicity is essential at all levels of the logistics system.

(6) *Timeliness*. Logistics support must be provided in the right quantity at the proper time and place for accomplishment of the mission.

(7) *Impetus*. The impetus of logistics support is forward to support the combat mission.

(8) *Cost-effectiveness*. Efficient management of logistics resources is essential to cost-effective logistics support.

(9) *Security*. Security of every facet of the logistics system must be maintained to preserve resources and insure sustained combat capability.

b. Logistics is a system made up of several technical functions and processes. It coexists with the Nation's economic system and the tactical concept of the combat commander. Logistics addresses the why and what in creation and support of forces, and management addresses how best to accomplish what is needed. Man-

agement is necessary for the logistics system as a whole as well as the subfunctions and processes which make up the system. To be effective, logistics need not be one system. But those charged with developing the strategies and tactics must know and understand how major elements of the logistics system behave under conditions of stress such as armed combat. They should understand the principles of logistics and their application at various levels of command. People with vision, imagination, and intuition are required to design, operate, and manage logistics. A further requirement is their willingness to work to achieve and maintain the required technical skills and understanding of how logistics relates to other elements of the military, in relation to business and industry, and the Government as a whole.

1-16. Summary

a. National purpose is achieved through the integration of all elements of national power—political, psychological, economic, and military. The strategy for employment of each element of power must consider the support that each element needs or will provide other elements. The national purpose dominates all strategy. Military strategy, as a means to attain national objectives, is developed along with the other strategies. Military force is used to meet any threat to national security and to preserve peace. It should not be used without a clear political purpose. The military force structure is determined by the perceived threat to national security; the willingness of the people to raise, equip, and support the force; and the ability of the economy to support and sustain the force. The national command authorities have the responsibilities to create, support, and employ combat forces. The civilian and military officials in the highest level of command must have control of the use of military force and determine when and where to use it; the resources which can be made available; scope of action; weapons to be employed; how the forces are to be used; and when the use will be terminated. From this level, there must be the perception and identity of threat. Joint commands then develop plans, in line with national objectives and capabilities, to counter the threat. The decisions of command in all situations are a blend of strategy, tactics, and logistics. The actual employment of the force is tactics in the direction of power to obtain objectives as determined by strategic concepts. Logistics creates and sustains the forces and weapons tactically employed.

CHAPTER 2 ORGANIZATION FOR LOGISTICS

Section I. MILITARY COMMAND STRUCTURE

2-1. General

Because the Army is not a self-contained, self-supporting organization, it must receive some support from governmental organizations, and other elements of the Department of Defense (DOD), that have been assigned support responsibilities by laws, DOD regulations, and other authority. This chapter describes briefly those organizations which provide logistics support to the Army.

2-2. Organization for National Security

a. The provision of the Constitution regarding common defense gives Congress alone the power to raise and support armies, provide for their employment, provide for control of the militia, vote money for military purposes, and to declare war. Congress exercises its constitutional control over the military forces by the enactment of legislation, including that involving appropriations and other actions, such as the conduct of investigations, incident to the enactment of legislation. Also, by the Constitution, the President of the United States is the Commander in Chief of the military services.

b. The single most important statute pertaining to the executive structure for national security is the National Security Act of 1947. This statute is the basis for the National Security Council (NSC), the Central Intelligence Agency (CIA), and DOD.

c. The organization for national security within the executive branch focuses on the NSC and its supporting subsidiary groups. The NSC advises the President on matters of integration of domestic, foreign, and military policies relating to the national security. The council is composed of the President, Vice President, the Secretary of State, the Secretary of Defense, and such other Secretaries and Under Secretaries of other departments and the military services as the President may appoint. The CIA, under the direction of the council, coordinates the intelligence activities of Government departments and agencies in the interest of national security. The planning and execution of national security measures involves some contribution from nearly every element of our governmental structure. The principal contributions are made by those represented on the NSC.

2-3. Department of Defense.

a. DOD is one of the principal agencies of the executive branch which assists the President in matters regarding the Nation's security. The Secretary of Defense, in effect, has two staffs: one primarily civilian (the Office of the Secretary of Defense (OSD)); the other primarily military (the Joint Chiefs of Staff (JCS) organization). Under the Secretary of Defense, the three military departments organize, train, equip, and maintain military forces designed to operate on land, sea, and in the air. The actual performance of military missions takes place under the direction of unified and specified combatant commanders appointed by, and responsible to, the President and the Secretary of Defense.

b. The Secretary of Defense is the principal assistant to the President in all matters relating to DOD. Under the direction of the President, and subject to the provisions of the National Security Act of 1947, as amended, the Secretary of Defense exercises direction, authority, and control over DOD.

(1) The Under Secretary of Defense for Policy (USDP) is the principal staff assistant to the Secretary of Defense for policy as it pertains to matters concerned with politico-military affairs, such as arms limitation negotiations, intelligence collection and analysis, communications, command and control, the use of outer space and integration of departmental plans and policies with overall national security objectives. The Assistant Secretary of Defense (ASD) (International Security Affairs (ISA)) who is also the Deputy Under Secretary of Defense for Policy is the principal staff assistant to the Secretary of Defense for matters pertaining to international security.

(2) The Under Secretary of Defense for Acquisition is responsible for the acquisition of all weapons systems of DOD including their research, development, test, and acquisition. He also coordinates resource and policy management of the closely related functions of telecommunications, command and control systems, and intelligence. He supervises the Defense Advanced Research Projects Agency, the Defense Communications Agency, the Defense Nuclear Agency, and the Defense Mapping Agency.

(3) The ASD Comptroller provides advice and assistance to the defense components in the performance of the Secretary's programing, budgeting, and fiscal functions and organizational and administrative matters pertaining to these functions, and the provision for the design and installation of resource management systems throughout DOD.

(4) The ASD for Health Affairs is responsible for DOD health and sanitation matters including the care and treatment of patients; preventive medicine; clinical investigations; hospitals and related health facilities; medical materiel; nutrition; drug and alcohol abuse control; and the acquisition, education and training, and retention of health personnel.

(5) *The ASD (Force Management and Personnel (FM&P))* is responsible for—

- (a) Manpower and personnel plans.
- (b) Policy, management and requirements.
- (c) Education and individual training.
- (d) Civil rights.
- (e) Equal opportunity.
- (f) Religious, morale, and welfare matters.
- (g) Per diem, travel, and transportation allowances.

(6) *The ASD (Production and Logistics) (ASD P&L)* is responsible for management of DOD acquisition, logistics, installation, associated support foundations and other related matters. The ASD (P&L) also exercises staff supervision over the Defense Logistics Agency (DLA). Other responsibilities include

- (a) Logistic management.
- (b) Supply and maintenance.
- (c) Transportation and services policy.
- (d) Installation and real property acquisition.
- (e) Maintenance and disposal.
- (f) Military base structure and utilization.

(7) *The Director (Program Analysis and Evaluation (PA&E))*, under the direction of the Secretary of Defense, formulates the force planning, fiscal programming, and policy guidance upon which DOD forces planning and program projections are to be based. From this guidance are developed defense objectives, policies, and fiscal constraints to be used as the basis for force planning and for developing changes to the defense program. The Director PA&E is also responsible for the conduct of studies and the analysis and evaluation of military forces, weapon systems, and equipment in relation to projected threats, U.S. objectives, resource constraints, and priorities established by the Secretary of Defense.

2-4. JCS

a. Chairman, Joint Chief of Staff (CJCS) is, by statute, the principal military adviser to the President, NSC, and the Secretary of Defense (10 United States Code 141b). JCS consists of the Chairman, Vice Chairman, the Chief of Staff of the Army; the Chief of Naval Operations; the Chief of Staff of the Air Force; and the Commandant of the Marine Corps. Among the functions assigned to JCS, the following have logistics significance:

(1) Prepare strategic plans and provide for the strategic direction of the Armed Forces.

(2) Prepare joint logistics plans and assign logistics responsibilities to the Armed Forces in accordance with those plans.

(3) Establish unified commands in strategic areas.

(4) Review the major materiel and personnel requirements of the Armed Forces in accordance with strategic and logistics plans.

(5) Formulate policies for the joint training of the Armed Forces.

(6) Formulate policies for coordinating the military education of members of the Armed Forces.

b. JCS is assisted by a Joint Staff limited by law to not more than 400 officers. It is headed by a director and composed of representatives, in approximately equal numbers, from the Army, Navy, Marine Corps, and the Air Force.

2-5. Unified and Specified Commands

a. The Armed Forces of the United States are organized for the performance of military missions into combatant commands made up of forces from the various military departments under the operational command of unified or specified commanders. A unified command is composed of significant assigned components of two or more services. A specified command is usually composed of forces from one service, but may include units and have representation from other services.

b. Unified and specified commands are assigned broad continuing missions. These commands are established, designated, and the force structure determined by the President, through the Secretary of Defense with the advice and assistance of JCS. It is also possible for a commander of an existing unified command to establish subordinate unified commands, joint task forces, and/or—in certain circumstances—a separate uniservice force. The Unified Command Plan contains the overall scheme of unified and specified commands and the

specific functions of each. The established unified and specified commands are:

Unified Commands

Atlantic Command (LANTCOM)
 Central Command (CENTCOM)
 European Command (EUCOM)
 Pacific Command (PACOM)
 Southern Command (SOUTHCOM)
 U.S. Space Command (USSPACECOM)
 Special Operation Command (SOCOM)
 U.S. Transportation Command (USTRANSCOM)

Specified Commands

Strategic Air Command (SAC)
 Forces Command (FORSCOM)

c. The commanders of unified and specified commands are responsible to the President and the Secretary of Defense. Hence, the chain of command runs from the President and the Secretary of Defense. Hence, the chain of command runs from the President to the Secretary of Defense, through the JCS to these commanders. JCS may issue orders to these commanders by authority and direction of the Secretary of Defense.

d. Once the force structure of the various unified and specified commands have been determined, each military department is responsible for furnishing the forces and logistics support, and remains responsible for the administration of these forces. The responsibility for support of forces assigned to combatant commands is vested in one or more of the military departments, as directed by the Secretary of Defense. No change will be made in the combat units assigned to unified and specified commands, except with the approval of the Secretary of Defense.

e. The military departments and services are charged by law with the responsibility (subject to the authority, direction, and control of the Secretary of Defense) for the logistics and administrative support of the forces assigned to unified or specified commands. Under conditions short of war, the scope of the logistics and administrative responsibilities exercised by the commander of a unified command is consistent with the peacetime limitations imposed by legislation, departmental policy or regulations, budgetary considerations, local conditions, and such other specific conditions as are prescribed by the Secretary of Defense or the JCS. Under wartime conditions and where critical situations make diversion of the normal logistics process necessary, the logistics authority and responsibility of commanders of unified commands are expanded to authorize them to utilize all facilities and supplies of all forces assigned to their commands as necessary for the accomplish-

ment of their missions under the approved war plan being implemented.

f. The commander of a unified command is authorized to exercise directive authority, within his command, in the field of logistics. The purpose of this authority is intended to ensure:

- (1) Effectiveness and economy of operations.
- (2) Prevention or elimination of unnecessary duplication of facilities and overlapping of functions among the service components of a command.

g. The commander of a unified command has specific authority to coordinate the logistics support of the service components and to exercise control of distribution of logistics support when shortages necessitate. The most common type of support is uniservice logistics support. Logistics support may also be provided by agreements on assignments in common servicing, cross-servicing, or joint servicing at force, theater, department, or DOD levels. Any combination of the foregoing types of servicing can be made to work and will provide suitable support to the U.S. forces within a unified command.

h. Other logistics responsibilities of a unified command are:

- (1) Coordinating salvage procedures within the command.

- (2) Civil engineering support planning.
- (3) Coordination of transportation facilities and means assigned to the command, including air, sea, and land transport.

(4) Responsibilities for operation of air and water ports outside the continental limits of the United States essential to logistics support of the unified command are assigned by the commander of the unified command. Normally, the establishment and operation of water ports will be a responsibility of the Army (Military Traffic Management Command). Exception to this policy can be made in the case of water ports primarily serving the Navy or the Air Force. However, the Army is the major user of water port facilities for debarkation and incoming supplies.

- (5) Coordination of graves registration service within the command for the acceptance of remains at collection points, including burial, burial records, and cemetery maintenance.

- (6) Coordination of medical and dental support.

- (7) Effective coordinated supply support. The unified commander develops overall policies and procedures concerning:

- (a) Supply distribution.
- (b) Levels of supply, including phased buildup.
- (c) Maintenance and repair.

- (d) Acquisition.
- (e) Allocation of initial classes and items of supply.
- (f) Allocation of supplies to civilians in an occupied area.

(8) Reviewing supply requirements of component forces to:

- (a) Eliminate duplication.
- (b) Insure needs of all forces are included.

(9) The commander of a unified command reviews requirements of the service components of the command and coordinates priorities and programs to effectively use supplies, facilities, and personnel; to promote effectiveness; and to provide a maximum balanced and uniform program in the furtherance of the command's mission. The commander also reviews the service component recommendations/requirements, from the component commanders to their parent military departments to verify that the recommendations are in agreement with the plans and programs.

i. With the exception of the commander of a unified command and members of the joint staff, the senior officer of each service assigned to a unified command and qualified for command by the regulations of his or her own service is the commander of the component of his or her service, unless another officer is so designated by competent authority.

(1) A component command consists of the component commander and all those individuals, units, detachments, organizations, or installations under his military command which have been assigned to the operational command of the commander of the unified command.

(2) Each component commander is charged with the responsibility for making recommendations to the commander of the unified command on the proper employment of his or her component, and for accomplishing such operational missions as may be assigned by the commander of the unified command. The component commander is responsible for the administration, discipline, training, logistics functions, and tactical employment of component forces.

j. Ordinarily, the requirements of forces of allied nations are furnished by the parent nation. A U.S. unified command may, as a result of bilateral agreements, provide support to the forces of allied nations. In the latter instance, the requirements for forces of allied nations would be screened by the U.S. unified command to insure their requirements are within the policies set forth in the agreement to assure the effectiveness of the U.S.

Forces is not impaired. In cases where the forces of the allied nations in question are operating under an allied commander, the requirements should be screened in the light of policies established by the allied commander.

2-6. The Military Departments

a. The Departments of the Army, Navy, and Air Force are major elements of the national security structure and the national military structure. Through their retained administrative responsibilities, or through the Interservice Support Program, the military departments maintain an active interest in almost every activity of United States Armed Forces worldwide.

b. Each of the military departments is headed by a civilian secretary. The secretaries are responsible for their department's performance of the functions and missions directed by the Secretary of Defense and by legislation. Among the functions assigned to all military departments are:

(1) Prepare forces and establish reserves of equipment and supplies for the effective prosecution of war, and plan for the expansion of peacetime components to meet the needs of war.

(2) Maintain mobile reserve forces properly organized, trained, and equipped for employment in an emergency.

(3) Provide adequate, timely, and reliable intelligence for use within DOD.

(4) Organize, train, and equip forces for assignment to unified or specified commands.

(5) Prepare and submit budgets, justify before Congress DOD approved budget requests, and administer the funds made available.

(6) Conduct research; develop tactics, techniques, and organization; and develop and procure weapons, equipment, and supplies essential to fulfill the functions assigned.

(7) Develop, garrison, supply, equip, and maintain bases and other installations, including lines of communication and provide administrative and logistics support for all forces and bases.

(8) Provide, as directed, such forces, military missions, and detachments for service in foreign countries as may be required to support the national interests of the United States.

(9) Assist in training and equipping the military forces of foreign nations.

(10) Provide, as directed, administrative and logistics support to the headquarters of unified and specified commands.

(11) Assist each other in the accomplishment of their respective functions.

Section II. ORGANIZATIONS EXTERNAL TO THE ARMY WHICH SUPPORT THE ARMY

2-7. National Level Logistics Responsibilities

There are numerous governmental organizations external to the Department of the Army (DA) which have a major impact on the Army Logistics System. This impact may be indirect or direct. For example, NSC has an indirect impact when it recommends national strategic objectives. These are translated into military force and equipment requirements to which the Army Logistics System must respond. On the other hand, agencies such as the General Services Administration (GSA) have a direct impact on the Army Logistics System since GSA supplies most of the common items used by all Government agencies (e.g., office furniture and janitorial supplies). In this section, we will examine some of those organizations which provide external logistics support for DA.

a. Office of Management and Budget (OMB). OMB assists the President in preparation of the budget, and the formulation of the fiscal program of the Government which includes the military services. It also supervises and controls the administration of the budget.

b. General Services Administration (GSA). GSA was created in 1949 to provide common supply and service support to all Federal agencies. This support is provided primarily through the six service organizations which have evolved since 1949. These organizations and their missions are:

(1) *Public Building Service.* This service is responsible for the design, acquisition, management, and maintenance of approximately 10,000 buildings for the Federal Government.

(2) *Federal Supply Service (FSS).* This service is responsible for economically providing other agencies with goods and services needed for day-to-day operations.

(3) *Federal Property Resource Service (FPRS).* This service is responsible for the management of both personal and real property for the Federal Government. Another important mission of FPRS is the management of the national strategic and critical materiel stockpile.

(4) *Transportation and Public Utilities Service.* This service is responsible for the development and oversight of programs governing transportation and traffic management; operating the 88,000-vehicle interagency motor pools; purchasing utility services for Federal use; and representing the U.S. Government as a consumer before bodies regulating utilities.

(5) *Automated Data and Telecommunications Service.* This service has been given the responsibility of acting as the general manager of the automatic data processing (ADP) and telecommunication service for the Federal Government. Included in this is the management of the acquisition, utilization, retirement, and sale of ADP and telecommunications equipment.

(6) *National Archives and Records Service.* This service is responsible for safeguarding 3 million of the Nation's most precious documents; managing and storing records of other Federal agencies; and providing guidelines on Federal office procedures and the control of paperwork.

c. General Accounting Office (GAO). Congress, among other things, has the power to declare war, raise and support armies, provide and maintain a navy, appropriate money, and make rules for the Government and regulation of the land, air, and naval forces. GAO was created as an independent agency of the legislative branch. It assists Congress in providing legislative control over the receipt, disbursement, and application of public funds. GAO is under the control and direction of the Comptroller General of the United States. GAO audits the receipt, expenditure, and application of public funds by the departments and agencies of the Federal Government. The primary purpose of these audits is to provide Congress independent examinations of the way in which Government agencies are discharging their financial responsibilities.

d. Department of Defense (DOD). The Secretary of Defense establishes general policies for the three military departments with respect to logistics activities. The DOD staff organization was described in paragraph 2-3.

e. Defense Logistics Agency (DLA). DLA is responsible for providing common supplies and services used by the military services. The mission of the agency is to: provide effective logistics support to the operating forces of all military services in war and peace, and to Federal civil agencies as assigned; provide the support at the lowest feasible cost to the taxpayer; and provide contract administration services in support of the military departments, other DOD components, the National Aeronautics and Space Administration (NASA), and other Government agencies upon request. The DLA areas of responsibility include worldwide integrated management of subsistence, petroleum, and property disposal operations. In general, DLA

provides logistical services and support to the Army in the field in the following areas:

- (1) Supply support.
- (2) Contract administration.
- (3) Technical and logistics services.

f. Transportation operating commands. The Secretary of Defense has established agencies to

furnish specific types of transportation support across DOD. The Military Traffic Management Command (MTMC), the Military Sealift Command (MSC), and the Military Airlift Command (MAC) are single managers charged with the provisioning of transportation services concomitant with their normal operational environment (see para 12-4).

Section III. DEPARTMENT OF ARMY ORGANIZATIONS FOR LOGISTICS

2-8. The U.S. Army Logistics System

The U.S. Army Logistics System encompasses the entire logistics activity of the Army at all levels. Differentiation in the scope and types of operations is made in the delineation of two major segments of the system: Army retail logistics and Army wholesale logistics (AR 700-9).

a. Army retail logistics is defined as those logistics functions performed at the general support, direct support, and user levels. It includes those logistics functions performed on or satellite upon a Continental United States (CONUS) installation and/or oversea operational equivalent and those logistics functions performed in a theater of operations to support a deployed U.S. army force.

b. Army wholesale logistics is defined as those logistics functions performed above the retail level. It is the portion of the Army Logistics System which includes the wholesale logistics complex composed of special Army activities retained under direct control of Headquarters, Department of the Army (HQDA), the national inventory control points (NICPs), national maintenance points (NMPs), service item control centers (SICCs), secondary inventory control activity (SICA), depots, terminals, arsenals, central wholesale data banks, plants, and factories associated with U.S. Army Materiel Command (AMC) activities.

2-9. Responsibilities for Logistics

a. Overall responsibility for all Army matters including Army logistics is vested in the Secretary of the Army. Similar to the DOD organization, the principal logistics advisors to the Secretary of the Army are the Assistant Secretary of the Army (Installations, Logistics, (ASA(I&L)) and the Assistant Secretary of the Army (Research, Development, and Acquisition) (ASA(RDA)). The Assistant Secretary (Manpower and Reserve Affairs) also has responsibilities which affect or contribute to the logistics effort. The Chief of Staff of the Army is the senior military officer in the Army. His Deputy Chief of Staff for Logistics (DCSLOG) is his principal logistics advisor. Other General Staff officers have logistics responsibilities. The Deputy

Chief of Staff for Personnel (DCSPER), Deputy Chief of Staff for Operations and Plans (DCSOPS), and the Deputy Chief of Staff for Intelligence (DCSINT) all have responsibilities relating to logistics as stated in AR 11-8. On the special staff, the Chief of Engineers is responsible for planning facilities engineering, power generation, and military construction; The Surgeon General (TSG) is responsible for medical logistics; and the Chief of Chaplains for ecclesiastical logistics. No one staff officer on the Army General Staff is solely responsible for the total logistics support of Army forces.

b. Major Army command logistic responsibilities are summarized briefly as follows:

(1) The U.S. Army Materiel Command (AMC) is responsible for the design and operation of the Army wholesale logistic system; it is also the single manager for conventional ammunition (SMCA). The SMCA is responsible for:

(a) Integration of conventional ammunition logistic functions of the military departments to the maximum extent practicable, thereby, eliminating unwarranted overlap and duplication.

(b) Achievement of efficiency and effectiveness in the DOD operation required to provide top quality conventional ammunition to U.S. Armed Forces during peacetime and mobilization.

(c) Maintenance of integrated production and logistic base to meet peacetime, surge, and mobilization requirements for assigned ammunition.

(2) The U.S. Army Training and Doctrine Command (TRADOC) has the following mission:

(a) Conduct all combat developments not assigned by HQDA to other commands and agencies; CG TRADOC will guide, coordinate, and integrate the Army's total combat development effort.

(b) Conduct all doctrine developments not assigned by HQDA to other commands and agencies. Integrate the Army's total doctrine development.

(c) Develop and maintain the training by which the total Army trains to fight. This is done per doctrine formulated by the doctrine development process.

(3) The Forces Command (FORSCOM) commands all operational divisions and strategic Army forces in CONUS, and through the CONUS armies, all USAR units, and is responsible for the combat readiness of the Army National Guard. The Commander, FORSCOM, serves as Commander of the Army Component, U.S. Atlantic Command.

(4) The U.S. Army Health Services Command provides health services for the Army in the United States and its territories.

(5) All of the above major commands also command installations and are responsible for providing installation logistic support to units and activities located on the installation or satellite on the installation for support.

c. At the retail level, responsibilities and methods for the provision of logistics support are varied, but may be summarized as follows:

(1) In a developed theater when functioning in an operational environment, the theater Army provides combat service to the Army forces and to other designated forces. This support includes direct support (DS) and general support (GS) to units in the theater Army area, GS to the corps, rear battle, and participation in stability operations. Theater Army normally contains five major subordinate commands: personnel command (PERSCOM), engineer command (ENCOM), transportation command (TRANSCOM), medical command (MEDCOM), and one or more theater Army area commands (TAACOM). The first four commands provide general combat service support to the theater Army and other forces and activities as the theater Army directs. The TAACOM provides DS supply and intermediate DS and intermediate GS maintenance and other services, (less medical, classified and GS map supply, and real property maintenance activities) to theater Army units and to units passing through or located in the communications zone (COMMZ) and to other forces as directed. For more detailed information on the theater Army, see FM 100-16.

(2) The corps is the largest self-contained organization which has combat, combat support, and combat service support functions. The corps consists of headquarters, a corps support command (COSCOM), a variable number (two or more) of divisions and other units such as artillery, signal, and engineer. The corps has no fixed organization. Its size and composition are determined by the

mission, availability of forces, use of nuclear weapons, probable hostile forces, climate and terrain. The COSCOM provides direct and general supply support, DS maintenance, and supports rear battle operations in the corps. The functions of the COSCOM include personnel and administrative service, civil affairs, DS maintenance, supply, transportation, and other services. COSCOM includes one or more support groups; ammunition, transportation, medical, and civil affairs, units; a materiel management center; a movements control center; and an ADP unit to support all appropriate combat service support functions of the COSCOM. For more information on COSCOM, see FM 63-3.

(3) In the division, the Division Support Command (DISCOM) provides DS combat service support to the division except military police, construction, and certain administrative services provided by division staff sections. DISCOM controls all division-level combat service support movements. The DISCOM organization is similar to that of COSCOM and contains an adjutant general company, medical battalion, supply and finance company, and a maintenance battalion. Slight variations in organization are reflected in the airborne, air assault, armor, mechanized, and infantry divisions. For more information on DISCOM, see FM 63-2.

(4) The installation is the lowest echelon responsible for providing logistics support to troop units and other designated customers. In addition to providing logistics support to units located on the installation, installation commanders perform area support functions for Reserve components, Reserve Officers' Training Corps (ROTC), recruiting stations, and other U.S. Army functions in the area. Involved in this responsibility are all of the functions of logistics management from obtaining to making timely allocation of resources. The primary mission of one installation may be the operation of an Army depot; another may operate a medical facility, a service school or training command; or it may serve as a training base for operating forces. Usually, an installation has several missions, but common to all are the logistics support functions required for mission accomplishment. Generally, these support functions are related to the local maintenance and management of facilities, intermediate materiel maintenance, supply management activities, property disposal, transportation and morale, and welfare services.

CHAPTER 3

ARMY LOGISTICS REQUIREMENTS AND RESOURCE MANAGEMENT

3-1. General

Chapters 1 and 2 provided background information for visualizing and understanding the Army Logistics System. This chapter describes the processes and responsibilities for managing logistics resources. It also includes considerations relating to other elements, such as environmental and congressional controls.

a. The bases for determining what personnel, materiel, facilities, and services are needed are the missions to be performed, degree and level of support to be furnished to the individual soldier, and the force structure as contained in the Defense Guidance stated by the Secretary of Defense. The individual military services determine within guidance what major weapons/equipment systems, and systems elements (personnel, repair parts, facilities, services, transportation, computer programs, financial programs, and technical data) are required to accomplish the services' missions. The satisfaction of these requirements is accomplished through the performance budgeting and working capital funding concepts established by Public Law (PL) 216, the first amendment to the National Security Act.

b. The performance type budget provides the basis for the resource management system. This system includes programing and budgeting, accounting, inventory management, operations management, and weapons/equipment information management systems.

c. It is necessary for the logistics managers to understand how requirements for weapons/equipment systems and their supporting elements are determined. They also must understand the principles covering the requirements processes as well as the processes for satisfying the requirements. An understanding of the interrelationships, functions, and purposes of the various parts of the resource management system is especially important.

3-2. Logistical Considerations

a. The focal point of logistics management is the soldier and the weapon systems. The basic purpose for the logistics system is to provide what is needed, where and when it is needed, in the condition it can be used, and at least practical cost.

b. Responsibility for providing logistics support is not solely that of the logistician. First, logistics

is a command responsibility. Commanders at all echelons must effectively utilize assigned resources so their units achieve a required readiness condition to accomplish the mission of the command. The commander should constantly strive to improve the efficiency of logistics functions and operations within the command. The commander should instill in all members of the command an understanding and appreciation of all aspects of logistics discipline. The commander should be aware of new concepts and improved procedures for logistics operations, advanced management techniques, information systems, and automation of logistics functions. Commanders must be cognizant of logistics areas of emphasis and logistics objectives as directed by Department of Defense (DOD) and Headquarters, Department of the Army (HQDA). They should also be familiar with the total Army goals established by the Chief of Staff which currently pertain readiness, civilian and military personnel, materiel, strategic deployment, future development, and resource management. All of those goals have logistics implications and show that the decisions or commands in an operational situation are a blend of strategy, tactics, and logistics. The following guidelines will help the commander carry out the logistics responsibilities:

- (1) Participate actively in logistics functions.
- (2) Provide guidance on the application of logistics regulations within the command.
- (3) Emphasize the training and career development of logistics personnel and the unit training of logistics units.
- (4) Hold subordinates responsible for unauthorized deviations from Army regulations, standard operating procedures, and standardized automated logistics functions/operations.
- (5) Stress responsibilities of subordinates for control and safeguarding of property.

3-3. Manpower Requirements

a. The functions of manpower management are to determine requirements; determine manpower availability; allocate available manpower to meet readiness goals; and monitor the employment of manpower to insure maximum use of available resources.

b. As discussed in chapter 1, the evaluation of the threat and the strategy to combat that threat leads to the determination of the number and

types of divisions required in the Army. From this the force planners can determine the numbers and types of combat, combat support, and combat service support units required to support those divisions. To this must be added the military and civilian positions needed to man, command, and control units and the major defense headquarters, agencies, activities, unified and specified commands, Department of the Army (DA), major Army commands (MACOMs), agencies, activities, and installations to support and train Army forces. To support, operate, and maintain the total Army structure, it is necessary to determine the quantitative and qualitative requirements. In general, there will be requirements for sizable numbers of personnel with widely diverse skills and grade ranges. The aggregate of these computations is the manpower requirement to support a doctrinally complete structure, fully manned and supported, which is capable of executing the strategy with minimum risk. From this, it is necessary to determine the level of structure and manpower required to support the strategy with an acceptable risk and one which the Nation can will support. In developing manpower requirements, it is necessary to consider many constraints. The availability of people with required skills or skill potentials; the availability of money to provide the required people; and the size force the Nation can support are three basic constraints. Factors such as grade limitations, "tooth-to-tail" ratio, facilities and installations capacities, time in service, time in grade policies, and other considerations must enter into the picture.

c. Another consideration is the turnover of the work force resulting from age and personnel changes due to transfers, discharges, temporary duty, promotions, and change of job assignments. One serious consequence of this turbulence is the shortage of skilled personnel in many critical areas including a reduction in the number of qualified noncommissioned officers in units.

d. Manpower is a basic resource which must be allocated and its use evaluated in the same way the utility and productivity of other resources are evaluated. AR 570-4 provides guidance relative to manpower management.

e. Identification of the manpower needs of the Army to execute assigned missions is the foundation of manpower management. The continuing increases in manpower costs affect the availability of funds to finance other programs. To offset these rising costs, it may be necessary to curtail, reduce, or discontinue other programs. Thus, every manpower space requirement must be adequately justified as being essential to mission accomplishment.

3-2 Change 1

Mission accomplishment is through the force structure designed to support the established strategy. This structure is made up of a combination of various type units which are designed to accomplish certain specific functions or interval tasks, such as receive, store, and issue ammunition; repair tanks; service aircraft; install communications-electronic equipment; build roads; haul gasoline; or bake bread. Each unit is designed to provide specific capabilities. Resources are allocated as necessary for the desired level of support. The standard document for establishing personnel and equipment requirements and authorizations for Army units is AR 310-49, The Army Authorization Documents System (TAADS). The following are products of TAADS:

(1) Tables of organization and equipment (TOE) prescribe the mission, organizational structure, capabilities, and personnel and equipment requirements for military units.

(2) Tables of distribution and allowances (TDA) prescribe the mission, organizational structure, personnel and equipment authorizations, and requirements for military units to perform missions at different levels of command for which TOEs are not appropriate.

f. The force structure (Active Army and Reserve components) is made up of units organized under TOEs, those organized under tables of allowances, and those individuals needed to insure units are fully manned. The size and composition of the structure is based on the enemy threat perceived, the strategy for combating the threat, doctrine, tactics, and other factors. Factors involved in determining manpower requirements for the force structure are illustrated in figure 3-1.

3-4. Materiel Requirements (Mission Area Analysis, see para 6-2)

a. The Army must be provided with equipment which will enable it to fight fast-paced combined arms battles against a potentially numerically superior enemy. The desirable situation is for the Army to have overall superiority over any potential enemy. Two major factors influence the determination of how the Army should be equipped.

(1) *Analysis of the threat.* The threat consists of the tactical concepts, equipment quality, numerical strengths of personnel, and major weapons/equipment systems and vulnerabilities. The intelligence system enables the U.S. Government to identify potential enemies and to assess threats so that U.S. forces will have superior battlefield equipment and will be able to prevent technological surprises and take advantage of beneficial foreign developments.

DETERMINATION OF MANPOWER REQUIREMENTS

Force Structure
Unit Requirements x Force Structure = Allowance + Individuals = Program
Total Manpower

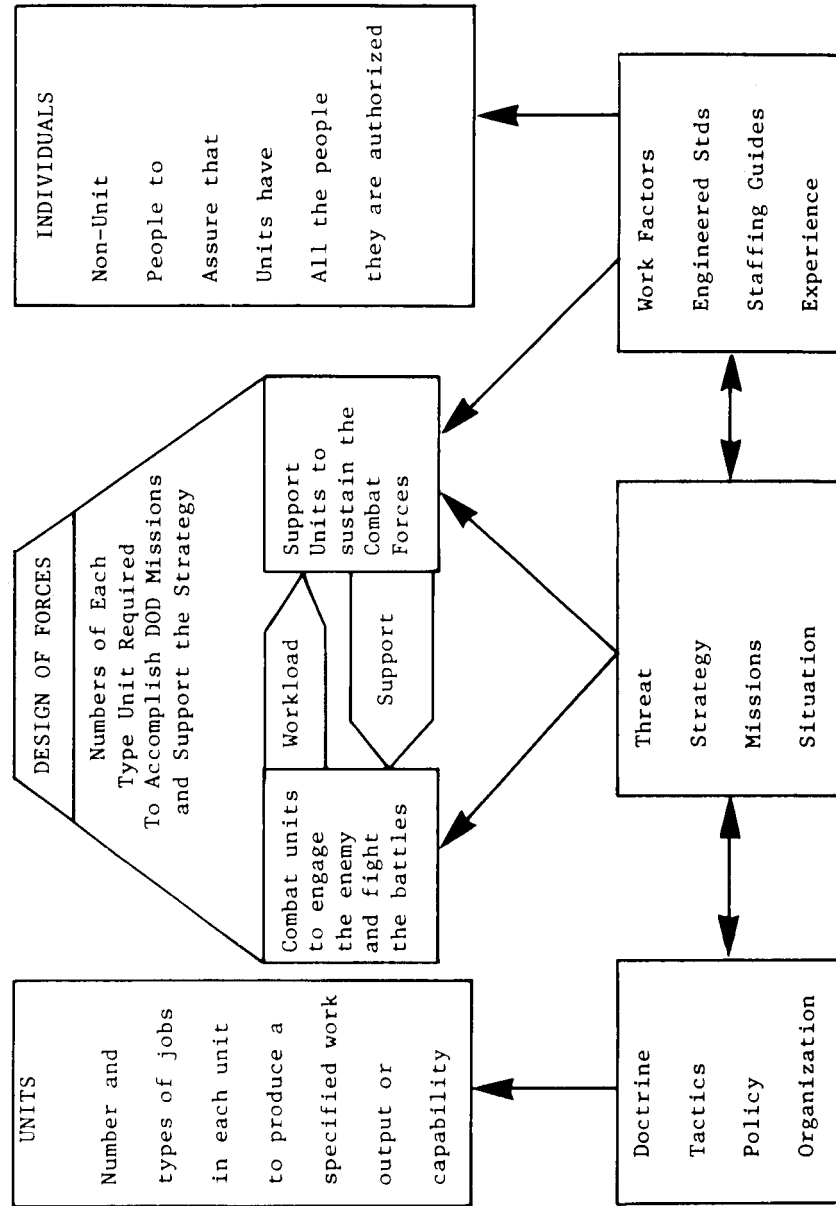

FIGURE 3-1

(2) *Definition of mission.* Congress has demanded that the U.S. military services define more precisely what their missions are. Congress wants to know what a system is expected to do and where the services are going with those systems. In response to the requirements of Congress, the Army, through studies and analyses, has delineated 16 major mission areas. These are close combat (heavy); close combat (light); communications; command and control; intelligence and electronic warfare; combat service support; engineering and mine warfare; special operations forces; fire support; nuclear, biological and chemical; ammunition; air defense; aviation; materiel acquisition base; training; and base operations. Within each mission area, all materiel items are combined into functional groups. Within these functional groups, the Army conducts effectiveness studies and cost analyses to determine the proper mix of weapons to counter the threat and maintain an advantageous force ratio. An important aspect of the analyses is affordability. This includes the money to buy the weapons/equipment system as well as that to operate it and maintain it in operation. It also includes manpower costs. In determining effectiveness of the system, it is necessary to consider three major capabilities: fire power, survivability, and mobility. The factors of reliability, availability, maintainability (RAM), and sustainability are included in defining the operational capability of weapons/equipment systems.

b. Having defined the missions, capabilities, and other characteristics required of the weapons/equipment systems, the next problem is to determine how to acquire the systems to fill the stated needs. This can be accomplished by using existing systems, by modifying existing systems, or by developing a completely new system. If a new system is required to fill the need, several alternatives face the Army decisionmaker. The new system can be developed by the Army and produced in-house or by commercial producers, or the system can be obtained from commercial or other sources. Items such as artillery pieces and ammunition which have purely military application are generally developed and produced in-house in either Government-owned, Government-operated or Government-owned, contractor-operated plants. Other systems/equipment such as roadbuilding, computer hardware, and general-purpose cargo vehicles which have general commonality with like-type commercial items are usually developed and produced in commercial facilities. Still another source of materiel to fill weapons/equipment systems and subsystem needs is the adoption of

systems developed and manufactured by other U.S. military services or those of allied nations. The objective in considering such systems as alternatives to Army developmental items is to obtain improved capability, decreased costs, earlier operational availability, fewer type systems, and an optimum degree of standardization and interoperability. Similar decisions are required regarding the repair parts and components needed for repair of the new weapons/equipment systems.

c. The weapons/equipment systems just discussed support the mission of a unit and are classified as major or principal items. These items are of such importance and high cost that they require centralized individual item management throughout the supply system. In the judgement of DA, there is a need for central inventory control, including centralized computation of requirements, acquisition and distribution direction, and central knowledge and control of all assets. Materiel management policies are enumerated in AR 700-9.

d. Other items required are those end items, repair parts and consumables (food, clothing, petroleum products), which support personnel or equipment. Some items are of high dollar value or are considered to be critical because of short supply, long leadtime, or other reasons and also require intensive management. Requirements for items which support personnel are based on personnel strengths. Items which support equipment requirements are based on equipment density, usage, operating conditions, failure rates of parts, and other factors. Actual quantities of major and secondary items acquired are based on TAADS, supply bulletins, tables of allowances and pertinent Army regulations.

e. Classes of supply: One method used for management of materiel is the grouping of the materiel into meaningful categories by commodity and/or commodity manager. Currently, all materiel is segregated into 10 easily identifiable categories. For a description of the class and subclass supply structure and its use as a management tool for logistics planning and operations, see FM 704-28.

3-5. Facilities Requirements

The types of facilities required by the Army are based on the systems to be supported and missions to be performed, whether it is a distribution system, maintenance system, education system, medical system, weapons system, or others. The logistical functions involved are the acquisition or construction, maintenance, operation, and disposition of facilities, and the management of those facilities. To support the Army, facilities are re-

quired in the United States, in friendly foreign countries, and in operational theaters. In the United States, facility requirements occur on military installations (post, camp, or station) and off an installation (Reserve centers, recruiting offices, engineer district offices, major command, agency, or activity headquarters, and others).

a. Each permanent installation is assigned missions and a troop stationing plan which are used to prepare the installation master plan. The plan

is based on DOD and DA guidelines. The principal guidance is contained in DOD Manual 4270.1 and AR 415-50 for basic facilities and space allowances; in AR 210-20 for master planning; and AR 210-50 for determining family housing requirements. Facility requirements are programmed annually by the installation commanders and submitted through channels for review and approval by HQDA, the Secretary of Defense, the Office of Management and Budget (OMB), and the Congress

who appropriates money for the acquisition or construction of the facilities.

b. In oversea areas, facility requirements may have their origin in direct master planning, in approved logistics studies developed at HQDA, or in civil engineering support (base development) plans prepared by commanders of unified or specified commands. These civil engineering support plans (CESPs) identify the major facilities (port, hospital, storage area, troop camp, highways, railways, airfields, security facilities, etc.) to be repaired (battle damage) or constructed to support contingency plans. These plans consider the number, kinds, and arrival dates of troops; accompanying supplies and equipment; and sustaining, replenishment, and reserve buildup supplies. New construction is minimized through the repair of damaged facilities, maximum use of other facilities, and maximum support from allies and host nations. In underdeveloped areas, adequate facilities to support a military operation do not exist, nor is there an adequate civil works capability to meet construction requirements, so U.S. and/or allied forces will be required to construct support facilities. More detailed discussion of civil engineering support planning is found in the Joint Operation Planning System discussed in chapter 5 and in FM 31-82, Base Development, and TM 5-302-1 and 2, Army Facilities Components System Designs, vols I and II.

c. Facilities requirements for support of a weapons system are identified in the Concept Exploration (CE) and Demonstration and Validation (D&V) Phases of the life-cycle system management model (LCSMM) and are stated in the logistics support plan for the system. Later, during the Full-scale Development (FSD) Phase, the facility requirements are verified and programing action initiated. The purpose of this program is to ensure all required facilities are available to the operating forces and supporting activities in a timely manner for the operation and logistics support of the system. Planning for these facilities is based on operations and maintenance analyses, equipment design drawings, specifications, and other documentation necessary for defining types of facilities, locations, space needs, environment, duration, frequency of use, personnel interfaces, installation activities, training requirements, test functions, and an assessment of existing facilities. The facilities portion of the logistics support plan includes criteria for further development of:

- (1) Real estate and construction specifications.
- (2) Primary facilities such as materials, power, communications, water, access roads, and critical real property.
- (3) Support facilities for personnel, training, storage, transportation, and administrative use.
- (4) Critical research and test needs.

(5) Facility life-cycle cost and budget estimates for the funding scheduling.

(6) Host-tenant agreements for support requirements.

Facility requirements for weapons/equipment systems support can be met by new military construction, modification of existing facilities, or acquisition of facilities outside the scope of military construction. Because of the leadtime involved, necessary programing action should be initiated early in the life cycle so military construction or other acquisition processes will parallel the schedules for the system and other elements of the system.

3-6. Transportation Requirements

a. Transportation is one of the basic elements of any logistics system. It provides the vital link between the user and the supplier. This includes a consideration of such items as what personnel and types of things in what volume are to be moved, from where to where, when, how often, and by what means. Consideration is given to safety, security, and special handling requirements, as well as desired locations for transportation equipment and facilities. Requirements are compared with availability of existing transportation systems and their capabilities by type, quantity, volume, and location to determine imbalances and shortfalls. The responsiveness of the logistics support effort to insure the operational readiness of military commands and weapons/equipment systems depends on the capability and adequacy of the transportation and related services. This requires the planning, coordination, direction, control, and supervision of all functions incident to transportation.

b. Management of transportation services is applicable not only to the U.S. military services but to the Nation as a whole. The U.S. military services do not have enough organic transportation to meet all possible contingency needs, but must depend on augmentation by commercial assets. Management processes of the Army transportation functions are described in chapter 4, AR 700-126, and in chapter 12 of this manual.

3-7. Financial Management

a. Because of their importance to the logistics support of the Army, budgeting and financing activities are critical elements of logistics management. Effective management of funds by DOD and the military services has long been a requirement imposed by Congress. Of particular concern are high personnel costs, high unit costs for weapons, and cost growth. The uppermost question in Congress is not how much money is asked for defense, but how defense money is to be spent. Every line item in the defense budget is re-

viewed by Congress to determine if it is justified.

b. Funding requirements for DOD are developed and presented in accordance with Planning, Programming, and Budgeting System (PPBS) described in chapter 4. Financial management is not only a function at the highest levels, but it extends down to the field command, the installation, and the operating level.

3-8. Management of Information

a. The rapid and tremendous advances in communications-electronics capabilities in the past 20 years have allowed the adoption of changed management practices and philosophies. The high degree of automation of information systems, coupled with improvements in analysis techniques (expanded simulation capabilities, operations research, statistical samplings, etc.) permits more reliable forecasts and evaluations over longer periods, and greater accuracy and volume of information. Centralized management rather than decentralized is more appropriate. However, the increased availability of information with which to manage can create problems for the manager if he or she does not participate in the process to identify, select, acquire, or distribute the information needed for management functions. The manager should determine what information is wanted, when it is wanted, in what format, and how current it must be. The manager, together with a management information specialist, can determine the source of the information, if it is currently available in an existing program and if it can be used with or without changes.

b. The growing dependence upon automated systems has been accompanied by new and complex security problems. Automation security has not kept pace with the growth of the general field of automation. Consequently, sensitive defense information handled by automated systems is subject to espionage, sabotage, fraud, misappropriation, misuse, or inadvertent or deliberate compromise. To provide protection against such possibilities, the Army has adopted the Army Automation Security Program which defines the maximum standards for the security of Army automated systems. This program, which implements DOD guidance contained in DOD Directive 5200.28 and DOD Manual 5200.28-M, is described in AR 380-380.

3-9. Unit Status Reporting

a. The Army's highest priority peacetime function, according to paragraph 4, AR 11-14, is to maintain an operational readiness status of the Active Army and Reserve components to permit timely mission accomplishment. The Army's unit combat readiness objective, as stated in AR 220-1, is to provide units capable of performing their TOE missions in support of op-

erational requirements. The responsibility of each level of command HQDA to units is to achieve maximum readiness with given resources and to accurately assess and report the actual status of units regardless of the resources allocated. These resources include personnel, training equipment availability, and equipment serviceability.

b. Each unit with a designated deployability posture must reach a logistics readiness condition which matches its authorized level of organization (ALO) for both equipment on hand and equipment readiness. Those units required early in support of contingency plans are normally maintained at the highest level of readiness. DA, through appropriate authorization documents, provides each unit an organic capability in personnel and equipment to accomplish assigned missions.

c. The commanders of MACOMs are provided guidance for improving logistics readiness. Under AR 11-14, major commanders establish a Command Logistics Review program. Details on this program are contained in AR 11-1. The basic objectives of the program are to provide a means to combine the efforts of HQDA (Deputy Chief of Staff for Logistics (DCSLOG)) and the MACOMs to solve problems identified through a bottom-to-top analysis of the logistics system.

d. The identity and description of the readiness status of each designated unit of all services is reported to the Joint Chiefs of Staff (JCS). These data support operations planning and command and control functions within the Office of the JCS, the commanders of unified/specified commands, the military services, their major commands, and DOD agencies. Since these data are a primary source to determine force availability, it is essential that changes in unit status be reported without significant delay. The U.S. Army Unit Status Reporting System, as outlined in AR 220-1, is an integral part of the JCS Unit Status and Identity Report (UNITREP).

e. Logistics indicators are:

(1) *Equipment on Hand (EOH)*. A logistics indicator depicting the organization's logistics status with respect to the on hand quantity of modification table of organization and equipment (MTOE) required equipment.

(2) *Equipment Readiness*. A logistics depicting logistics status with respect to the percentage of MTOE required equipment fully mission capable.

(3) *Equipment Status*. A logistics indicator depicting logistics status with respect to the percentage of "on hand" equipment fully mission capable.

(4) *Unit Status Ratings*. Ratings are designed to provide indicators of the degree to which a unit is

capable of performing the wartime mission for which it is organized.

3-10. Logistics Assistance Program (LAP)

a. As further aids to the commander for attaining the required readiness posture in the unit, DA has established several programs. Among these programs are:

- (1) Logistics Readiness (AR 11-14).
- (2) Maintenance Assistance and Instruction Team (MAIT) Program (AR 750-1).
- (3) New Equipment Training Team (NETT) Program.

(4) Technical assistance by intermediate direct support (DS) and intermediate general support (GS) units and activities (AR 750-1).

b. Despite these programs, commanders are frequently faced with logistical problems which they cannot solve using existing resources. These problems may be the result of the:

- (1) Introduction or major modification of a weapons/equipment system.
- (2) Introduction of new logistics procedures.
- (3) Lack of trained or experienced personnel.
- (4) Introduction of major modification or automatic logistics data systems.

c. DA recognizes such problems exist. It also recognizes new equipment is becoming more and more complex, equipment density in relation to personnel is increasing, and the rate of personnel turnover is high. With this knowledge in mind, DA established the LAP under AR 700-4; the objectives of this program are to:

(1) Assist commanders in resolving those logistical problems on materiel readiness which are their responsibility, but are beyond their capability to resolve with organic resources.

(2) Analyze field operations for their impact on logistics; determine requirements for improvement, and use information derived from analyses to help commanders resolve problems which are beyond their capability.

(3) Improve materiel and its logistics support based on information from both weapons and equipment analyses and the experiences of daily contact with using units as well as from all other sources.

(4) Assist other U.S. Government agencies with problems related to Army-managed materiel.

d. The purpose of this program is to assist the commander in accomplishing those functions relating to unit readiness. The program is intended to provide assistance in response to specific requests for resolving particular logistics readiness problems with emphasis on supply and maintenance

and related functions of training, funding, and concepts/doctrine which impact on readiness. This program provides direct assistance to accomplish force modernization by keeping Commanders informed, through the use of trained logisticians and technicians, of new weapons and equipment systems. The program also insures that required actions are taken for the smooth transition and sustained support of new weapons and equipment systems. It also provides direct assistance by evaluating the performance of unit weapons/equipment systems, and the support furnished by the materiel supplier. Through equipment performance reports submitted by technicians in the field, the materiel developer receives information which is useful in making improvements in fielded systems through the design of product improvements and the design of new similar type items. Logistics/technical reports are provided the materiel readiness/commodity commands regarding the responsiveness of the support furnished by the materiel readiness commodity commands to the using commands. Technicians also report to the using commands their observations of the capabilities of the units performing their logistics mission and the status of their supply, equipment, and personnel capabilities.

e. The U.S. Army Materiel Command (AMC) has established a worldwide LAP administered through Logistics Assistance Offices (LAOs) which carry out logistic assistance activities to include technical assistance, help in resolving nonroutine problems, and thus foster good customer relations. LAOs are established at MACOMs, corps, division, and other appropriate combat support/combat service support activities having significant AMC involvement. Since the assistance program covers Active Army and Reserve components, the LAOs are assigned support missions in specific geographical areas as described in AR 700-4.

f. The LAP is planned, programmed, budgeted for, and executed by the AMC Major Subordinate Commands.

3-11. Materiel Fielding Concepts

The materiel fielding concept was developed to promote user satisfaction with the materiel/equipment systems in the initial fielding operations for which the materiel developer has responsibility.

a. *Materiel Fielding Plan (MFP)*. The MFP contains all the planning information and actions required to provide logistics support for an item to be newly deployed to the field. All development, product improved, new commercial, and other non-developmental materiel systems have MFPs provided by the materiel developer/fielder. A separate

MFP will be prepared for each gaining MACOM, or, at the option of the materiel developer/fielder, a single MFP will be prepared with appendices for each gaining MACOM. Development of the MFP begins during Full Scale Development (FSD) and is oriented to and coordinated with the gaining MACOM. In its final form, the MFP contains all the detailed plans, schedules, procedures, action and status necessary to successfully deploy, process, and sustain a new item in the field. The MFP includes a Materiel Fielding Agreement (MFA) which both the gaining MACOM and the materiel developer/fielder sign. Signature of the MFA constitutes agreement with the MFP and the responsibilities stated therein.

b. Materiel Fielding Operations.

(1) If the fielding operations are performed in part or in total by a contractor, the materiel developer/fielder does not relinquish his responsibility to the gaining MACOM. The materiel developer/fielder must be prepared to react to the user's needs if there is inadequate or incomplete contractor performance.

(2) For complex materiel systems, the materiel fielder may provide a materiel fielding team (MFT) to support the gaining command during the initial fielding period.

c. Total Package Fielding (TPF). Under TPF, the fielding command requisitions end items, associated support items of equipment (ASIOE), interchange items spares, special tools and test equipment (STTE), PLL/ASL repair parts, and publications. These items are consolidated at the depot/unit materiel fielding point (UMFP) and shipped as a complete package to a handoff point. The receiving units and AMC representatives make a joint inventory of the package at the

handoff site for issue. The package includes the documentation required to establish unit records; e.g., PLL/ASL build cards, SAILS catalog cards and receipt documentation. The complete package is a free issue to the user.

d. For further information on materiel fielding, see AR 700-127, AR 700-142, and DA Pam 700-142.

3-12. Materiel Transfer Concepts.

The materiel transfer concept was developed to ensure that materiel systems, which are displaced due to the fielding of new or improved systems, remain fully supportable.

a. Materiel Transfer Plan (MTP). For selected displaced systems, an MTP will be prepared. The MTP contains all the planning and actions required to provide logistics support for such systems. The MTP includes a Materiel Transfer Agreement which the supporting, losing, and gaining MACOM sign.

b. Memorandum of Agreement (MOA). The MOA will be used to transfer displaced systems which are not covered by the MTP. The MOA is jointly prepared by the losing and gaining MACOM and contains all the planning and actions required to effect the transfer.

c. Additional Guidance on Materiel transfer is contained in AR 700-127, AR 700-142 and DA Pam 700-142.

d. The materiel transfer process requires that equipment be transferred in TM 10/20 standards condition, and assigns responsibility to the losing command to effect upgrade to transferable condition. Aircraft will be transferred in accordance with TM 55-1500-328-25.

PART TWO: JOINT STRATEGIC PLANNING SYSTEM

CHAPTER 4

PLANNING, PROGRAMMING, AND BUDGETING

Section I. PLANNING AND REQUIREMENTS

4-1. Introduction

a. National military decisions in support of foreign policy issues and national security matters are the responsibility of the President. Presidential decisions result from the analysis of these issues and matters, determination of alternative courses of action, evaluation of each, and presentation of pertinent knowledge to permit clear policy choices. The determination of the best course of action is made by the President. His decisions are announced in the Presidential Directives (PDs).

b. The Secretary of Defense, based on recommendations of the members of his staff, officials of the military departments, Joint Chiefs of Staff (JCS), and other Department of Defense (DOD) agencies, translates national security decisions, policies, and objectives into plans, programs, organizational assignments, and implementing guidance for the elements of DOD. The decisions of the Secretary of Defense are made under the authority of the Defense Reorganization Act of 1958. This legislation gave the Secretary of Defense, under the policy guidance and direction of the President, two distinct lines of authority; a direct line of command through JCS to the unified and specified commands and a line for administrative control of the military departments and management and support of the military forces. This administrative line of control is the basis of the Planning, Programming, and Budgeting System (PPBS) by which the Secretary of Defense submits DOD requirements to the President for inclusion in the presidential budget submitted annually to Congress.

c. Basically, the PPBS process can be summarized as follows:

(1) From the threat perceived, strategy is developed to counter that which is most dangerous and most likely to materialize.

(2) Force requirements are developed to support the strategy.

(3) Programs are developed to document and justify the resources for achievement of force objectives, weapon systems objectives, and their logistics support.

(4) Budgets are formulated to allocate the resources provided by Congress to support requirements for execution of approved programs.

(5) The PPBS results in the DOD portion of the President's budget which is submitted to Congress in

January and is reflected in the DOD Five-Year Defense Program (FYDP).

d. Army programing and budgeting is accomplished within the context of the PPBS annual cycle. The programing phase is initiated on the basis of the strategic planning documents prepared annually by JCS and the fiscal guidance of the Secretary of Defense.

4-2. General

The magnitude of individual programs in support of military planning requires the commitment of resources over many years into the future. In fact, the first-year budget for these programs often represents only a small part of the total expenditures necessary if the end objectives are to be realized. Hence, the planned use of resources toward specific national objectives has become increasingly critical. From these kinds of considerations, two primary goals of overall defense management have emerged: first, there must be a continual analysis of total force structures for all the services in terms of common missions or national objectives; and second, the resource impact or financial requirements of proposed force structures must be projected over an extended period of years. These goals are met through a planning, programing, and budgeting process containing five major elements:

a. A program structure in terms of missions, forces, and weapon support systems.

b. The analysis and comparison of alternatives.

c. A continually updated FYDP.

d. Systematic year-round decisionmaking on new programs and changes.

e. Progress reporting to test the validity and administration of plans and programs.

4-3. Program Objectives vs. Resource Inputs

Until the early 1960s, military support management was based on a system of budgeting and control according to resource inputs rather than on any set of programmed national objectives. Military planning and budgeting were tailored to some arbitrary appropriation ceiling which Congress arrived at within the overall Federal budget. Although there is sound justification for not spending more on defense than the "economy can afford," the result was an inefficient allocation of

- PROGRAM 1. STRATEGIC FORCES: CONSISTS OF, AS MAJOR SUBDIVISIONS, STRATEGIC OFFENSIVE, STRATEGIC DEFENSIVE, AND CIVIL DEFENSE. INCLUDES COMMAND ORGANIZATIONS ASSOCIATED WITH THESE FORCES. FOR THE ARMY, THIS CONSISTS OF SAFEGUARD AIR DEFENSE COMMAND AND CIVIL DEFENSE.
- PROGRAM 2. GENERAL-PURPOSE FORCES: CONSISTS OF FORCE-ORIENTED PROGRAM ELEMENTS OTHER THAN THOSE IN PROGRAM 1, INCLUDING THE COMMAND ORGANIZATIONS ASSOCIATED WITH THESE FORCES, THE LOGISTICS ORGANIZATIONS ORGANIC TO THESE FORCES, AND THE RELATED LOGISTICS AND SUPPORT UNITS WHICH ARE DEPLOYED OR DEPLOYABLE AS CONSTITUENT PARTS OF MILITARY OR NAVAL FORCES AND FIELD ORGANIZATIONS. FOR THE ARMY, THIS CONSISTS OF THE MAJORITY OF ARMY COMBAT SUPPORT FORCES.
- PROGRAM 3. INTELLIGENCE AND COMMUNICATIONS: CONSISTS OF MISSION AND ACTIVITIES DIRECTLY RELATED TO COMBAT FORCES, BUT NOT A PART OF ANY OF THE FORCES LISTED IN PROGRAM 1 OR 2 ON WHICH INDEPENDENT DECISIONS CAN BE MADE. INCLUDES RESOURCES FOR PRIMARILY NATIONAL OR CENTRALLY DIRECTED DOD OBJECTIVES FOR INTELLIGENCE AND SECURITY; COMMUNICATIONS; SPECIALIZED MISSIONS SUCH AS WEATHER SERVICE, AEROSPACE RESCUE RECOVERY, AND OCEANOGRAPHY. FOR THE ARMY, THIS CONSISTS OF INTELLIGENCE AND SECURITY ACTIVITIES AND OTHER SPECIALIZED ACTIVITIES OFFICE OF EMERGENCY PLANNING, NATIONAL MILITARY COMMAND SYSTEM, AND COMMUNICATIONS SYSTEMS SUCH AS US ARMY COMMUNICATIONS COMMAND.
- PROGRAM 4. AIRLIFT/SEALIFT: CONSISTS OF AIRLIFT, SEALIFT, AND OTHER TRANSPORTATION ORGANIZATIONS BOTH INDUSTRIALLY FUNDED AND NONINDUSTRIALLY FUNDED. INCLUDES COMMAND, LOGISTICS, AND SUPPORT UNITS ORGANIC TO THESE ORGANIZATIONS. FOR THE ARMY, THIS IS PRIMARILY ARMY PORT TERMINALS AND MTMTS.
- PROGRAM 5. GUARD AND RESERVE FORCES: CONSISTS OF NATIONAL GUARD AND RESERVE TRAINING UNITS. ELEMENTS ARE ARRANGED IN PROGRAM NUMBER ORDER TO FACILITATE THE RELATING OF THE GUARD AND RESERVE TRAINING FORCES TO THE ACTIVE FORCES.
- PROGRAM 6. RESEARCH AND DEVELOPMENT: CONSISTS OF ALL RESEARCH AND DEVELOPMENT ACTIVITIES WHICH ARE NOT RELATED TO ITEMS WHICH HAVE BEEN APPROVED FOR PROCUREMENT AND DEPLOYMENT. THE COST OF RESEARCH AND DEVELOPMENT RELATED TO OPERATIONAL SYSTEMS WILL APPEAR IN APPROPRIATE ELEMENTS IN OTHER PROGRAMS. FOR THE ARMY, THIS CONSISTS OF ALL ARMY RESEARCH AND DEVELOPMENT ACTIVITIES NOT RELATED TO SPECIFIC ITEMS (SUCH AS LIGHT OBSERVATION HELICOPTER, SHELLALEIGH) WHICH HAVE BEEN APPROVED FOR PROCUREMENT AND DEPLOYMENT.

Figure 4-1. The DOD 10 major forces programs.

PROGRAM 7.	<u>CENTRAL SUPPLY AND MAINTENANCE:</u> CONSISTS OF SUPPLY AND MAINTENANCE NOT ORGANIC TO OTHER PROGRAMS; INCLUDING NONDEPLOYABLE SUPPLY DEPOTS AND MAINTENANCE DEPOTS, BOTH INDUSTRIALLY FUNDED AND NON-INDUSTRIALLY FUNDED.
PROGRAM 8.	<u>TRAINING, MEDICAL AND OTHER GENERAL PERSONNEL ACTIVITIES:</u> CONSISTS OF TRAINING, MEDICAL AND OTHER ACTIVITIES ASSOCIATED WITH PERSONNEL, EXCLUDING TRAINING SPECIFICALLY IDENTIFIED WITH ANOTHER PROGRAM ELEMENT AND EXCLUDING HOUSING, SUBSISTENCE, MEDICAL, RECREATIONAL, AND SIMILAR COSTS THAT ARE ORGANIC TO ANOTHER PROGRAM ELEMENT (SUCH AS BASE OPERATIONS).
PROGRAM 9.	<u>ADMINISTRATION AND ASSOCIATED ACTIVITIES:</u> CONSISTS OF RESOURCES FOR THE ADMINISTRATIVE SUPPORT OF DEPARTMENTAL AND MAJOR ADMINISTRATIVE HEADQUARTERS, FIELD COMMANDS, AND ADMINISTRATIVE ACTIVITIES (NOT ELSEWHERE ACCOUNTED FOR), CONSTRUCTION SUPPORT ACTIVITIES, AND MISCELLANEOUS ACTIVITIES.
PROGRAM 10.	<u>SUPPORT OF OTHER NATIONS:</u> CONSISTS OF ELEMENTS IDENTIFIED TO THE SECURITY ASSISTANCE PROGRAM AND THE AGENCY FOR INTERNATIONAL DEVELOPMENT PROGRAMS AND THOSE RESOURCES ASSIGNED TO ELEMENTS RELATED TO OR SUPPORTING THE MILITARY ASSISTANCE PROGRAM.

Figure 4-1. Cont'd.

the resources which could be afforded. In practice, Congress would (and still does) approve a defense budget structured according to appropriation categories; for example, so much for military personnel, so much for new construction, and so on. The individual services would then get their cut of the pie and would have to make decisions concerning competing needs within the service. Herein lay the deficiency. To achieve the optimum allocation of resources in terms of missions, competing needs must be evaluated without regard to service boundaries. Thus, the first link in the planning-programing-budgeting chain is planning and programing according to missions or national objectives.

4-4. Planning and Programing According to Missions

a. Broadly considered, planning and programing at the present time in both DOD and the Department of the Army (DA) involve: first, the selection of meaningful courses of action through systematic analyses of alternatives. This is the planning emphasis in the planning-programing process. The more specific determination of resources necessary to follow the course of action is the programing emphasis. What this means is that in the planning, programing, and budgeting

process, program decisions are made after comparing projected costs and effectiveness of feasible planning choices.

b. DOD is managed in terms of 10 major force programs. These 10 major programs represent the primary mission to be performed within DOD. These programs are defined in figure 4-1, emphasizing their meaning to the Army. Major force programs are made up of subunits called program elements. The program elements are the forces, weapon or support systems, and other types of activities through which the missions are accomplished. They are the categories according to which the forces, dollar costs, and manpower requirements are identified. Figure 4-2 is an illustration of program elements in the other services as well as the Army.

4-5. Budget Appropriations and Program Elements

a. The Army budget and accounting system is structured according to DOD program elements. Because of this, the program element structure is referred to as the program/budget structure. This makes the Army management system of accounts consistent with DOD program elements. In this way, the defense budget,

GENERAL-PURPOSE FORCES - PROGRAM 2	CENTRAL SUPPLY AND MAINTENANCE - PROGRAM 7
<p>FORCES (ARMY)</p> <p><u>COMBAT FORCES</u> DIVISIONS ARMORED DIVISIONS MECHANIZED DIVISIONS SEPARATE BRIGADES INFANTRY BRIGADES AIRBORNE BRIGADES OTHER COMBAT UNITS MISSILE COMMANDS INFANTRY (SEPARATE BATTALIONS)</p> <p><u>COMBAT SUPPORT FORCES</u> FIELD ARTILLERY BATTALIONS TARGET ACQUISITION BATTALIONS GUN (175MM) HOWITZER BATTALIONS (8 INCH) AVIATION UNITS HELICOPTER COMPANIES (HEAVY) SURVEILLANCE COMPANIES (LIGHT) AIR DEFENSE UNITS VULCAN/CHAPARRAL BATTALIONS HAWK BATTALIONS OTHER COMBAT SUPPORT COMBAT SUPPORT UNITS COMBAT ENGINEER BATTALIONS</p> <p><u>COMBAT SERVICE SUPPORT FORCES</u> THEATER ARMY SUPPORT COMBAT SERVICE SUPPORT COMMUNICATIONS CORPS SUPPORT COMMANDS</p>	<p><u>SUPPLY</u> GENERAL SUPPORT SUPPLY DEPOTS OPERATIONS INVENTORY CONTROL POINTS OTHER CHANGES IN WORKING CAPITAL DEFENSE LOGISTICS AGENCY - HEADQUARTERS FIRST DESTINATION TRANSPORTATION SECOND DESTINATION TRANSPORTATION</p> <p><u>MAINTENANCE AND SERVICE ACTIVITIES</u> AERONAUTICAL MAINTENANCE ACTIVITIES ARSENALS ELECTRONIC AND COMMUNICATION MAINTENANCE ACTIVITIES VEHICLE MAINTENANCE ACTIVITIES PROVING GROUNDS MUNITIONS FACILITIES WEAPONS FACILITIES DEPOT MAINTENANCE FACILITIES MISSILE FACILITIES LOGISTICS SUPPORT ACTIVITIES</p>

NOTE: THE ABOVE CATEGORIES ARE INCOMPLETE; ONLY A SAMPLING OF EACH IS INTENDED.

Figure 4-2. Sample other services program elements.

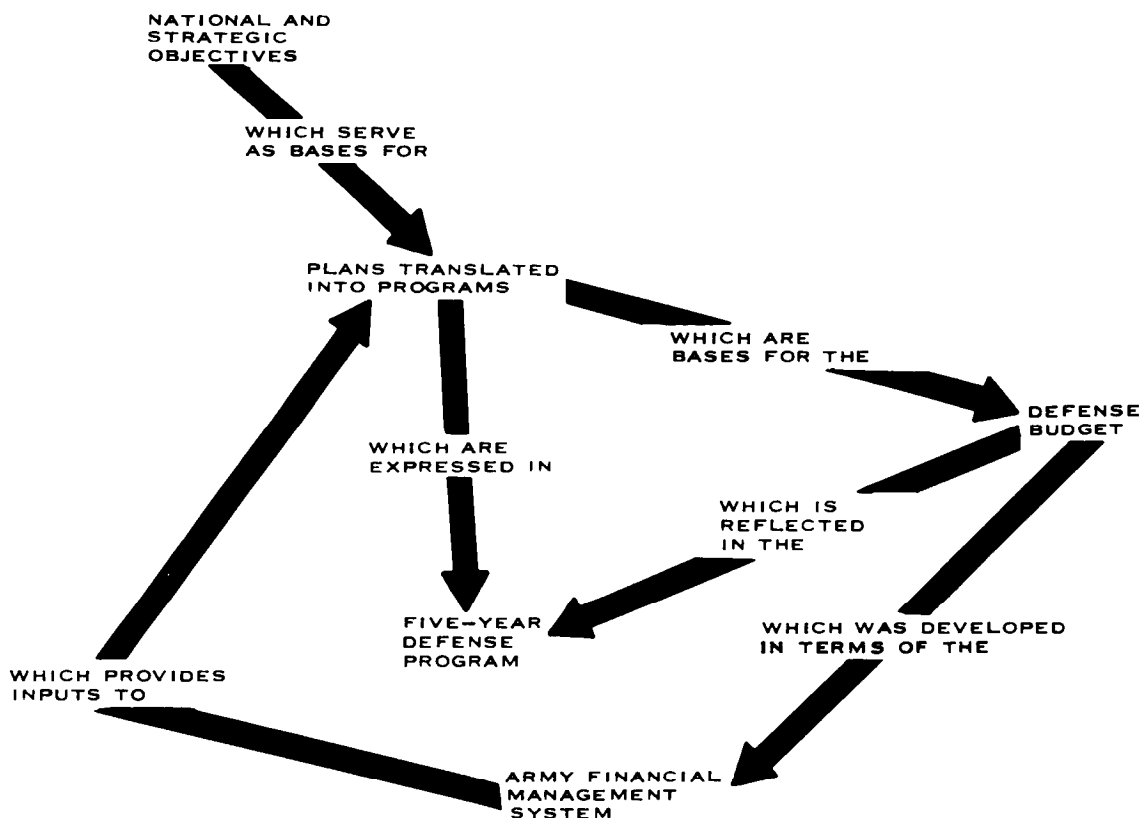

Figure 4-3. The planning, programming, and budgeting cycle.

through the Army's (as well as the other services') financial accounting and reporting system, forms a closed continuous loop with the planning and programming processes.

b. In general, the Army consolidates certain accounts (this is done at DA level) to make its budget comparable with DOD program elements; there are significant differences from a management standpoint between structuring a budget according to appropriations and structuring it according to program elements.

c. In the case of appropriations, costs or obligations are viewed in terms of inputs to the system; e.g., personnel pay, new construction, and research. While this budgeting rationale affords control on how funds are to be expended, it fails to indicate what, in terms of specific objectives, is actually being bought. Thus, the manager has no basis for evaluating how efficiently funds are being allocated among alternatives.

d. By budgeting according to program elements, on the other hand, appropriations can be made according to some kind of optimum payback criteria. Further, by collecting costs according to responsibility centers, which in effect are what the program elements are, there is a basis for measuring the relative performance

of operating activities and sharpening the planning processes.

4-6. Planning, Programming, and Budgeting as a Closed Loop

a. Planning, programming, and budgeting is a continuous process. It should be thought of as a closed loop, with the link from budgeting back to planning being the Army Financial Management System. This concept is summarized in figure 4-3.

b. The basic point of entry into the loop is the long-range planning process, since this planning is general in terms of national objectives and specific missions. Consistent with these long-range plans, a more concrete plan is made for a 5-year period. This is the essential frame of reference for the whole planning, programming, and budgeting process and is known as the FYDP. It is expressed in terms of forces or areas of responsibility required to achieve the designated missions. The resources represented by these program elements are expressed in the FYDP by year and program element in terms of research, investment, operating expenses, force units involved, and military and civilian end strengths for mission or support activities.

c. Using this defense program as a guide, the Army prepares its budget for the coming year to meet its portion of the overall program. Then during the execution of the budget, through the Army accounting and reporting system, performance can be measured and a hard data base built to support future planning.

4-7. National Security Planning

a. Defense planning is concerned with strategic, tactical, and organizational concepts; technological forecasts; and intelligence estimates. Taken together, these lead to the broad force requirements needed to accomplish assigned missions during specified time frames. In a sense, the planning process provides answers to what, why, when, where, and who. The answers to how are provided in the programming phase.

b. Plans are of many types. Broad plans are made at the top echelons, while more detailed planning is conducted throughout the subordinate elements. The basic direction of the overall defense effort is governed by national security policy. These policies, prepared by the National Security Council (NSC), mainly from Presidential Review Memoranda, are contained in PDs.

c. In preparing the National Security Study Memoranda, drafts are referred to the Office of the Secretary of Defense (OSD), the military departments, and JCS to ensure military views are given due weight.

4-8. Joint Strategic Planning System

a. Translation of the basic national security policy into military objectives is accomplished by JCS through a Joint Strategic Planning System. This planning system consists of long-range, midrange, and short-range plans as explained below.

b. The Joint Long-Range Strategic Appraisal (JLRSA) considers the intelligence estimates and provides views of JCS concerning the role of US military power in the long-range period and outlines broad strategic implications which should be considered in the preparation of studies, estimates, appraisals, policies, plans, and research and development (R&D) objectives. As the name implies, it is a long-range plan.

c. The Joint Strategic Planning Document (JSPD) is a midrange planning document. It is used by JCS to advise the President, NSC, and the Secretary of Defense on the military strategy and force level needed to obtain national military objectives. Additionally, the JCS uses the document to state their position on matters of strategic importance to the national security for reference in Presidential and NSC-directed actions. The JSPD appraises the threat to U. S. interests worldwide and recommends military objectives and strategy to attain national objectives in the midrange period. It summarizes levels of JCS planning forces

which, with reasonable assurance, could successfully execute approved strategy. Moreover, it comments on their attainability considering fiscal responsibility, manpower resources, and materiel availability as well as technology and industrial capacity. The document provides a foundation for recommendations on force planning guidance and changes to the Defense Guidance (DG).

d. The Joint Strategic Capabilities Plan (JSCP) provides guidance to the commanders of unified and specified commands and to chiefs of services for the accomplishment of military tasks, based on projected military capabilities and conditions, for the short-range period. The JSCP contains military strategy, based on projected available forces, to support the national security objectives and the derived military objectives; and it includes planning guidance on forces, logistics, intelligence, and the development of plans.

e. The Joint Program Assessment Memorandum (JPAM) is issued by JCS about 30 days after the military services publish their Program Objectives Memorandum (POM). The JPAM gives the views of JCS on the adequacy of the composite force and resource level presented in the service POMs. Specifically, the JPAM assesses force balance and capabilities including recommended levels of support. The Secretary of Defense considers this JCS analysis when deciding program issues during the summer issue cycle preceding final approval of service POMs.

4-9. Army Planning

a. Joint plans are, of necessity, quite broad in scope. They shape the long-range development of the three services and provide guidance for capabilities to be attained; however, supplemental refinement and updating are continuous requirements. Based on this, the services are directed by JCS, on an annual basis, to prepare or revise the departmental plans used in support of joint planning.

b. The Army Planning, Programming, Budgeting and Execution system (PPBES) is the management system employed by DA to insure effective use of resources (see AR 1-1). It responds to and is dependent upon the DOD PPBS and Joint Strategic Planning System. The system is designed to provide timely input of Army views which will appropriately influence the policy, strategy, force objectives, and other considerations of the Secretary of Defense and Joint Staff and also provide timely guidance to the Army Staff and commanders. The primary objectives of the Army PPBES are to explain the strategy, structure the forces, allocate resources, and ensure readiness of the total force. (See PPBES Handbook, published by the Director, Program Analysis and Evaluation, Office of the Chief of Staff, DA.)

c. The Army Strategic Appraisal is the basic document of Army Staff planning with regard to strategy and provides the basic threat analysis for use by the Army. It addresses the midrange period (3-10 years) and provides Army views on military policies and strategy based on Presidential, NSC, and OSD pronouncements. It is organized on a worldwide and regional basis, and contains: identification of national security interests and objectives and major national security policies; an analysis of the threat to the United States interests and objectives and identification of gaps in required intelligence; and regionally oriented appraisals, strategic concepts, and military objectives to achieve the national security objective.

d. The Army guidance document is based on the Army Strategic Appraisal; applicable policy and planning guidance of the Secretary of Defense; and the JSPD. It provides guidance to the Army Staff for developing the Army forces and appropriate support programs to execute the national strategy. It includes guidance for developing the objective force level, resource requirements, and alternative force levels which need detailed analysis.

e. The Army Force Program develops in detail the Army force structure approved by the Secretary of Defense for the current and budget years. The objective of the Army Force Program is to develop a balanced Army force which can be supported with sufficient resources to attain authorized levels of organization (ALOs). Approved planning forces from the POM in conjunction with command troop list submissions form the basis for structuring the programmed force. The approved programmed force is sent to the field for implementation. Each unit within the Army force structure is displayed and maintained in the Master (M) Force, a component part of the Force Accounting System. The Master Force is based on a continuous force programming procedure in accordance with the latest budget and structure decisions. The Army Force Program establishes the Active Army approved force (troop list) and the Active Army Military and Civilian Manpower Programs for the current and budget years; develops force programming guidance; provides a projection of asset demands and availability; presents a schedule of activations, inactivations, reorganizations, and deployment; and supports the Army budget request through the entire budget cycle.

f. The Army Mobilization and Operations Planning System (AMOPS) provides administrative and operational guidance to Army agencies, Army commands, and Army component commands of unified commands for the employment and/or support of Army forces in the short-range period. It reflects specific tasks and capabilities attainable within existing programs and

budget limitations. The AMOPS uses the planning assumptions of, and is, the Army implementer for the JSCP.

4-10. The DOD Programing System

a. In the programing activity, the military objectives formulated in the planning phase are studied, and the first attempt is made to develop a dollar cost for resources involved in the accomplishment of these objectives. Up to this point, the resources required have been evaluated in broader terms, such as the overall number of forces which may be employed and other factors which would provide some definition of the quantities and qualities of materiel required. The programing process details in much more realistic terms the specific forces, what the specific requirements in materiel are, when they will be available, and their cost.

b. The focal point of DOD programing activities is the FYDP. Since reprogramming is a continuous process, the FYDP must be current to guide and control short-notice implementation and to govern planning for future periods. To keep it current, specific updating procedures have been prescribed by DOD. These require each military department to maintain current program data for submission to the Assistant Secretary of Defense (Comptroller) (ASD(C)) on an "on-call" basis reflecting reprogramming actions and manpower changes approved by the head of each military department, and other changes specifically approved or directed by the Secretary of Defense or ASD(C) since the previous update.

c. The proposed force changes are the most significant of all the reviews which go into updating the FYDP. Essentially, top-level attention is focused on "big ticket items" within DOD, referred to as major force-oriented issues. Top management attention is given to major force-oriented issues early in the planning, programing, and budgeting process and provides for continuing thorough analysis of these critical issues until decisions on them are made.

d. The POM is the means by which the Army, as well as each military department and defense agency, expresses its total program requirements to DOD. POMs are based on JSPD strategic guidance as modified by the OSD Defense Guidance. The POM must provide force, manpower, cost, materiel recommendations, rationale for proposed changes from the approved FYDP, risk assessment, and military advantages to be gained. DOD decisions of POM are processed as a Program Decision Memorandum (PDM).

e. Management control devices are found throughout the DOD programing systems. For example, mile-

stone schedules are required in many of the program element review reports and are used as a basis for overall management control. A "milestone" is a significant event or occurrence during the life or scheduling of an equipment item, extending through the development, production, and operational phases to obsolescence and removal from inventory. It indicates whether the particular item is developing as originally projected or whether it needs additional management attention to bring it to the desired operational state.

f. A threshold is another device used to control unilateral program changes. Thresholds are total obligation authority points beyond which prior DOD approval is required before a change can be made to an Army program.

4-11. Army Programing

a. The defense programing system is used by military departments, services, and other defense agencies. Internal procedures vary from service to service because of the differences among the services. The Air Force, for example, because of its functional organization and mission, is perhaps in the best position to relate programs to operations and operations to programs with a minimum of interpretation. The Navy, while in a better position than the Army to align operations with programs, has a more complex structure than the Air Force due to a vastly different mission in the scheme of national security. The Army has the most variety in a breakdown of its mission, coupled with a much wider diversification in arms and services. Other separate defense agencies are organized along functional lines, and the missions are relatively simple in comparison with those of the military departments.

b. Programing proceeds under guidance issued by the OSD. Within specified constraints, programing activity translates JCS and Army planning into a comprehensive and balanced allocation of projected forces, manpower, materiel, and funds for a 5-year period. The detailed allocation, published each May as the Army POM, goes to the Secretary of Defense for review in terms of overall defense needs. As approved by the Secretary of Defense, the POM established the Army 5-year program, whose first year provides the basis for developing annual budget estimates.

c. The Army programing system encompasses the areas from requirements review through program reporting and execution control. It provides a 5-year base program upon which detailed execution plans may be established. It formulates and records the major objectives of the Army and furnishes guidance to the Army Staff and major commands (MACOMs) and agencies in preparation of annual program execution schedules.

d. The Army programing system is a uniform method of relating programing, budgeting, accounting, manpower, and logistics management. Documentation of the programing system ties in closely with the overall DOD programing system. Program guidance to major commands and agencies is issued in the Program and Budget Guidance (PBG). It provides dollars and manpower resource guidance for the 28 commands and operating agencies which submit Program Analysis Resource Reviews (PARRs) and Command Operating Budgets (COBs). This document is updated and issued three times annually.

e. In developing, for inclusion in the POM, the specific Army forces required, materiel requirements and cost implications to meet the guidance in the Army Guidance, the Army makes several analyses. One, the U.S. Army Operational Readiness Analysis (OMNIBUS) is an annual assessment of the readiness of the current Army forces. It analyzes the projected conditions and capabilities at the end of the fiscal year (30 September) preceding the first year of the current POM. The Total Army Analysis (TAA) which is used to develop the Army's program force, analyzes the force as of the end of the last fiscal year of the forthcoming POM. The Army Logistics Analysis (ALA) is conducted annually to assess the capabilities of the logistics system to support the OMNIBUS Force.

4-12. The Budget Structure

a. The budgeting phase of the planning, programing, and budgeting process basically is the translation of approved programs developed during the planning and programing phases into financial terms. As a common denominator of personnel, materiel, and services, dollars are used as the principal control vehicle in the administration of Army activities. The Army management system of accounts provides the mechanism for recording and reporting financial information for management control purposes.

b. The Army budget is only part of the total DOD budget which, in turn, is part of the overall Federal budget reviewed and approved by the Congress. Thus, a situation exists where the needs of the Congress make it necessary for DOD, and consequently the Army, to express its budgets in terms of appropriations and budget programs/activities, instead of just program elements. The major appropriations of the Army budget are shown in figure 4-4. These appropriations represent the various resource inputs which support Army operations. The Army budget categories are compatible with DOD program elements. The budget categories are the basis for the Army account structure. Correlation tables relate each account to the appropriate program element.

MILITARY PERSONNEL, ARMY

OPERATION AND MAINTENANCE, ARMY (OMA)

 STRATEGIC FORCES
 GENERAL PURPOSE FORCES
 COMBAT DEVELOPMENT, INTELLIGENCE, AND COMMUNICATIONS
 CENTRAL SUPPLY AND MAINTENANCE
 TRAINING AND OTHER GENERAL PERSONNEL ACTIVITIES
 MEDICAL ACTIVITIES
 ADMINISTRATION AND ASSOCIATED ACTIVITIES (CONUS-WIDE)
 SUPPORT OF OTHER NATIONS

AIRCRAFT PROCUREMENT, ARMY

MISSILE PROCUREMENT, ARMY

PROCUREMENT OF WEAPONS AND TRACKED COMBAT VEHICLES, ARMY

PROCUREMENT OF AMMUNITION, ARMY

OTHER PROCUREMENT, ARMY

RESEARCH, DEVELOPMENT, TEST, AND EVALUATION, ARMY

MILITARY CONSTRUCTION, ARMY

NATIONAL GUARD PERSONNEL, ARMY

OPERATION AND MAINTENANCE, ARMY NATIONAL GUARD

OPERATION AND MAINTENANCE, ARMY RESERVE (OMAR)

RESERVE PERSONNEL, ARMY

MILITARY CONSTRUCTION, ARMY NATIONAL GUARD

MILITARY CONSTRUCTION, ARMY RESERVE

GENERAL APPROPRIATION - CIVIL FUNCTIONS

Figure 4-4. Major Army appropriations.

4-13. Budget Formulation

a. The Comptroller of the Army, subject to the authority and direction of the Secretary of the Army, has statutory responsibility for Army budgeting. The Comptroller discharges this function through the Director of the Army Budget. Formulation of the Army budget as part of the total DOD planning, programing, and budgeting process is continuous and it follows from

the planning and programing activities. While planning and programing move from the highest echelons down, the budget is built from the lowest echelons up. The echelons in the budget formulation process actually correspond to the levels of responsibility for the various levels in the Army fiscal account structure. The budget programs under the Procurement Appropriations shown in figure 4-4, for example, are termed

"major programs." The Army General Staff and The Surgeon General are responsible for major programs. A further breakdown of the major program is called a subprogram. Subprograms consist of "program elements" which, in turn, consist of "activities." Finally, activities break down into "elements of expense." Hence, the process is essentially one of preparing budgets according to the management structure of accounts at the lowest responsibility levels, consolidating these in terms of higher responsibility levels, and aggregating into appropriation summaries.

b. The Army Management Structure (AMS) is a system of symbols and titles which identify the purpose and distribution of funds appropriated by Congress (see AR 37-100-XX).

c. From a management viewpoint at DA level, the important budget building blocks are the individual operating budgets at the major command levels (e. g., U.S. Army Materiel Command (AMC), U.S. Army Training and Doctrine Command (TRADOC), U.S. Army Forces Command (FORSCOM)) and at the installation levels (e.g., Fort Benning and Letterkenny Army Depot).

d. The passage of the Congressional Budget and Impoundment Control Act of 1974 introduced a fiscal process with greater involvement on the part of the Congress. To assist the Congress in performing its increased responsibilities, the legislation provided for the formation of a budget committee within both the House and the Senate as well as a Congressional Budget Office to assist both Houses. The legislation requires Congress to make coordinated annual decisions on total Federal budget authority, outlays, revenues, public debt levels, and budget surplus or deficit. Impact on the budget year as well as outyears is to be considered by Congress. In addition, the legislation provides detailed procedures and deadlines for a congressional budget process tied to a fiscal year beginning on 1 October and ending on 30 September. Under this system, the President will submit his budget to Congress in January.

e. The new budget will cover the 12 months beginning the following 1 October. By 15 April, the House and Senate budget committees should propose resolutions offering a congressional version of the right spending levels for the period. Congress should complete action on the measure by 15 May to guide but

not bind its decisions on individual spending bills and new proposals. By 15 September, revised resolutions must be adopted taking account of all spending Congress has voted with the inclusion of firm budget ceilings. If appropriations exceed the total in the resolution, Congress must cut spending, raise taxes, or consciously agree to an increased deficit so the figures balance by 25 September. Congress, by law, cannot adjourn until the job is accomplished. In theory, the system enables Congress to end what has been a piecemeal operation, and to deal with the issue of overall Federal spending, weighing programs against each other, and deciding where the emphasis and the money should go.

4-14. Budget Execution

a. The budget execution process can be thought of as being the budget formulation process in reverse. That is, while in the formulation process, higher echelons of authority were reviewing and adjusting appropriation estimates (needs) from lower echelons; in the execution process, the lower echelons must adjust their individual operating budgets to the appropriation levels approved by Congress.

b. Possibly the most important aspect of the budget execution process is that it serves as a vehicle for review and control of Army activities. Although Army appropriations are in the congressionally approved Presidential Budget, the services must continually reexamine and rejustify these funding needs through quarterly program reviews. The rationale for this is recognition that commanders can only estimate future needs. As the actual need for funds grows closer, situations can be appraised more accurately, and finer estimates (up or down) can be made on budget requirements. These refined estimates become the basis for control actions to realign resources and adjust requirements. Any realignment of resources must be performed within constraints placed upon reprogramming. These constraints are imposed by the Congress, the OSD, and others to withhold some authority to reprogram funds. The commander, advised by the financial management staff officer, should ensure that realignment is consistent with constraints imposed upon the command. Thus, the execution of the budget flows back into the planning and programing activities. The flow is made possible through the Army financial management system, based on AMS accounts and reports.

Section II. ARMY FINANCIAL MANAGEMENT

4-15. General

There are two basic concepts underlying Army financial management: a commander must be provided with the resources necessary to perform an assigned mis-

sion; and a commander must be held accountable for the use of those resources. Hence, the major elements of financial management also became important man-

agement tools for the logistician. The systems for working capital funds and consumer funds, as well as the systems for accounting for expenses, obligations, and inventories, serve a twofold purpose. First, they facilitate the budget execution process and allow for the appraisal of individual operations. Second, they provide individual commanders with the means for planning, administering, and measuring the performance of their operations.

4-16. Working Capital Funds

a. DOD has continually stressed the use of commercial-type practices in the management of its resources to obtain maximum effectiveness, efficiency, and economy of operations. At the same time, the department is most interested in having an accounting system which reflects the cost of performance of its programs and activities. To achieve these results, the Secretary of Defense has been authorized the use of working capital funds. As a result, stock and industrial funds exist in each of the military services. These funds serve dual purposes:

(1) To finance inventories of stores, supplies, materiel, and equipment.

(2) To provide working capital for industrial-type activities and for commercial-type operations.

b. To finance these activities, the Secretary of Defense is authorized to have the Secretary of the Treasury transfer certain unused balances of appropriations available to the various military departments into special Treasury cash accounts for the various working capital funds which have been established. The amount is left to the discretion of the Secretary of Defense. Also, additional appropriations may be made by Congress to provide needed working capital in excess of that available. The working capital funds operate on the revolving fund concept, whereby once the fund has been set up sales to customers provide the necessary cash to continue operations.

c. Thus, a revolving fund is a fund established for a given purpose, and expenditures to accomplish the purpose are made from this fund. When the funded activity has rendered the service or produced the product for which it was created, it then recovers the cost from the individuals or agencies which contracted for the goods or service. In this way, to the extent the funded activity furnishes services or goods to individuals or organizations outside the Government, the Government is recovering its costs from such activities in cash. To the extent it is governmental agencies which benefit, the cost is charged against the appropriation of the benefiting agencies. In the latter instance, the cost of goods or services ordered by

the users (consumers) is normally controlled by the amount of appropriated funds available to them.

d. From a management standpoint, all working capital funds, whether stock funds or industrial funds, have certain objectives. Some of the more important are:

(1) To improve management through:

(a) Creation of managerial and accounting units.

(b) Organization of like activities to permit a balance between local management responsibility and authority and overall centralized control.

(c) Use of commercial-type, accrual-basis accounting.

(d) Closer accounting for the cost-of-performing functions with tighter control on costs.

(e) Provisions of a basis for comparing costs with those of private industries.

(2) To provide greater flexibility in financing and budgeting by making it no longer necessary to request annual appropriations from Congress to finance the operations of activities of this nature. Annual availability of appropriated funds can be ignored as a factor in timing purchases. At the same time, appropriate fiscal control over the conduct of these activities is exercised through the apportionment process (obligation authority).

(3) To permit Congress to appropriate funds on the basis of what is to be used during the budgeted year, not on the basis of production. This contributes to the aims of a performance-type budget.

(4) To provide the using agencies with cost data. Through the use of a consumer-type budget, maximum cost consciousness is promoted. Thus, critical appraisal of the benefits to be derived as compared to the cost to be incurred in connection with purchases from the funded activity is possible. Additionally, comparison of alternative uses for the funds available to the using agencies may be made.

4-17. The Army Stock Fund (AR 37-111)

a. In general, any stock fund is a revolving fund established to provide a simplified means of financing and accounting for the purchase, holding, and sale of consumable-type common-use items. When a stock fund is established, all inventories of supplies and equipment in the categories to be covered by the fund are given a dollar valuation as assets (capitalized). Additional cash for working capital is provided. As supplies and equipment are sold to customers, inventories are converted into cash. On the basis of past demands, forecast changes to these demands, and the inventory level,

new obligation authority is requested to replace the items needed. The cash generated from "sales" is used to pay the vendors for the materiel. The buyer-seller relationship created by the revolving fund concept is designed to achieve:

(1) Freedom from the limitations of 1-year appropriations, permitting the purchase of stocks at times and in quantities which provide the most economic supply.

(2) Economies in supply operations through the financial inventory accounting system, which causes the users to buy consumable supplies rather than receive them on a "free-issue" basis.

b. Over 90 percent of all line items of Army-managed wholesale inventories are procured by, held in inventory by, and sold from AMC. The retail divisions operate from a home office (MACOM) with separate branch offices located at various installations levels in CONUS, at corps and subordinate command level in Europe, and at command level in the Pacific areas. They procure, hold, and sell all items required by the consuming activities except for those principal and secondary items centrally controlled and financed with appropriated funds at the wholesale level. Retail divisions procure supplies and equipment from AMC, Defense Logistics Agency (DLA), General Services Administration (GSA), local nonmilitary sources, and in some instances, from other military services.

c. Management of the stock fund requires control of inventory levels from both an item and a dollar viewpoint. As such, there is a dollar limitation on the acquisition of inventory; e.g., Obligation Authority (OA) or Acquisition Authority (AA). This authority is the dollar limitation placed on the amount of inventory that any one stock fund entity may order during a fiscal period; e.g., quarter or year. Although cash may be available for purchasing inventory, the stock fund cannot ultimately spend it unless it has the proper authority to place the order. The administrative restriction of acquisition/obligational authority is imposed on the operation of the stock fund in order to control the inventory levels.

d. Responsibility for overall direction and supervision of the Army Stock Fund is vested within the Office of the Deputy Chief of Staff for Logistics (ODCSLOG). The responsibility for management and control of the wholesale stock fund is delegated to the Commander, AMC. Retail divisions are managed by each major command having retail supply responsibilities.

e. The Army has established certain criteria which must be met to qualify an item for inclusion in the Army Stock Fund. The fund includes inven-

ories of consumable-type supplies and common-use, standard stock items, which may be considered to be consumed when they are sold (issued) to consumers.

f. The current method of stock fund operations within the Army preserves the use of the appropriated funds made available for supply support of the consuming activities, until the time the supplies are issued to those activities—thereby showing costs and expenses in the year they actually occur. This permits valid cost performance budgeting and accounting and facilitates the preparation of forecasts and control of the funds appropriated to support those budgets. A variation to that method of stock fund operation is the simultaneous obligation policy. That policy permits consumer funds to be obligated concurrently with stock fund obligations for those items that are not stocked or are at zero balance at the retail level. This procedure allows consumer funds to be obligated in the year the requisition is submitted, thereby reducing the potential loss of appropriated funds.

4-18. The DLA Stock Fund

a. This stock fund, the newest of those in DOD, was initiated in 1962. Modifications and changes through the summer of 1965 resulted in an organization comprising six centers (including five inventory control points (ICPs)), each under a single commodity manager.

b. These defense supply centers maintain centralized inventory control. All supply management functions, such as requisition processing, inventory accountability, financial accounting, reporting, billing, and collecting are performed at these centers. Servicing, administrative support, and technical advice are furnished by the Defense Logistics Service Center (DLSC), the Defense Industrial Plant Equipment Center (DIPEC), and the Defense Technical Information Center (DTIC).

c. DLA, using its own stock fund, is responsible for supply management and procurement of assigned commodities for DOD. Items purchased and held by the DLA Stock Fund are wholesale stock. The individual military service (customer) uses its own funds to obtain materials from the DLA Stock Fund.

4-19. The Army Industrial Fund (AR 37-110)

a. In general, an industrial fund is a revolving fund established to provide working capital for the operation of commercial-type or industrial-type activities which manufacture goods for, or furnish services to, customers within the departments and agencies of DOD. Each industrial fund consists of

cash, accounts receivable, inventories of materiel, supplies, and work in process, and all other current assets except the land, plant, and equipment of the activity. The fund is used to finance the cost of goods produced or services rendered. The fund is reimbursed for the goods or services from the appropriate funds of the customer (consumer).

b. Industrial funding eliminates accounting for several appropriations, allotments, and suballotments by using the single revolving fund concept. It provides a more effective means of controlling costs of goods or services produced or rendered. Each industrial fund has an accounting system tailored to its specific purposes which shows its cost to produce goods or render services. The relationship between the industrial fund activities and the activities which order, receive, and pay for the end products or services to the industrial fund is similar to the relationship between the buyer and the seller in the marketplace. The industrial fund concept encourages cross-servicing among the military departments and agencies of DOD to obtain the most economical use of facilities. The cost-of-performance budget is enhanced by eliminating "free issues" since the customers (consumers) must budget for the costs of the end products received from the industrial funds.

c. The operation of an installation or activity under an industrial fund is comparable to that of a business which produces and sells goods and services. The cost to produce those goods or services are included in the selling prices. The buyer of the goods or services is placed in the position of being able to find fault with the selling prices. This criticism extends to quality and speed of delivery of the goods or services ordered in comparison with relative cost of similar performing activities of outside agencies. This emphasizes effective and economical management of those activities for which the industrial fund concept has been devised. A recent innovation is the stabilized fixed-price/rate billing concept. This concept provides that buyers will be billed at fixed prices, fixed hourly rates, etc., which are set in advance of performance, and are not to be changed except for a change in scope of work.

d. Industrial funds have been installed at Army arsenals, depots, transportation terminals and research activities. Industrial fund charters have been issued to AMC and the Military Traffic Management Command (MTMC). The charters authorized and govern industrial fund operations pursuant to prescribed policies, procedures, and reporting requirements.

4-20. Consumer Funds

a. The concept of placing maximum responsibility for the management and control resources as close to the point of consumption or use of these resources as possible is consumer funding. The scope and significance of this funding have increased considerably by using working capital funds and by requiring cost-of-performance budgeting and detailed accounting and reporting. Each installation commander receives appropriated funds through the command channels. These funds finance operations and maintenance activities such as the pay of civilian personnel, locally contracted services (utilities and communications), and supplies and equipment procured from stock-funded sources, from GSA, or by local procurement from civilian sources. Under this concept, stock funds, and consumer (appropriated) funds become mutually supporting. The stock funds initially finance the costs of procuring and holding inventories; later the consumer funds reimburse the stock funds for supplies and equipment purchased from the stock fund. Through this procedure, cost-of-performance budgeting is accomplished since the funds appropriated by the Congress are expensed at the time of consumption of goods and services, and are not used for procuring and holding inventories. In essence, consumer funds are operating and maintenance funds used to pay for the items described above.

b. The Army has consumer funding at every post, camp, station, and separate activity worldwide which is incorporated into the Resource Management System. Under this system, the installation's commander prepares a detailed Command Operating Budget and forecasts the requirements for a given fiscal year. The commander is subsequently provided with an allotment of funds, generally from the appropriation OMA, with which to procure the goods and services to support his approved Command Operating Budget. The commander is then held accountable for the use of those funds to accomplish the program.

4-20.1. Conventional Ammunition Working Capital Fund (CAWCF) (AMC-R 37-13).

a. The purpose of the CAWCF is to finance the process of acquiring components and assembly into conventional ammunition end items in support of the Army's single manager for conventional ammunition (SMCA) mission.

b. The CAWCF is a cost control mechanism that fosters optimum consolidation of DOD and other

Federal requirements. Standard processes are established annually for DOD requirements and are discounted based on procurement savings realized.

4-21. Management Funds

a. In general, a management fund is a fund set up by contributions or authorizations from other funds or appropriations for the performance of a common task. Such funds are used to finance, administer, and account for either a continuing or a one-time project and for transactions involving appropriations of two or more commands or offices of a specified military department. Management fund accounts are established only upon approval of the Secretary of Defense. The accounts established may be managed and operated by a single department under its management fund either when its commands and offices are the only participants or when two or more departments or other agencies of DOD are participating in the project.

b. The Army Management Fund was created to simplify operations which are financed by two or more appropriations. Examples of activities which have been financed through the fund are:

- (1) Defense Telephone Service, Washington, DC.
- (2) Interagency transportation services.
- (3) U.S. Army Engineer Command, Europe.

4-22. Installation Funding

a. As a result of previous installation budget submissions to higher headquarters, funding is received at the installation in the form of obligation authority contained on a Funding Authorization Document (FAD). The command, to which the FAD is issued, is then responsible for preventing any overobligation or overexpenditure of funds. The funding or obligation authority received is of three types: direct obligation authority, funded reimbursement authority, and automatic reimbursement authority.

b. Direct obligation authority is for support of mission activity at the installation. It is a specific amount (or limit) which is cited on the FAD and is immediately available for obligation upon receipt of the FAD.

c. Funded reimbursement authority is for support of specific nonmission but essential activity at the installation. It is a specific amount (or limit) which is cited on the FAD, but it is not immediately available for obligation. It is available for obligation only upon receipt of a firm reimbursable order.

d. Automatic reimbursement authority is for support of nonmission but essential activity at the installation. The authority to engage in automatic

reimbursement transactions, rather than any specific amount, is received on the FAD. It is not immediately available for obligation, but rather becomes available only upon receipt of a firm reimbursable order.

4-23. Nonappropriated Funds

a. Nonappropriated funds are established by authority of the Secretary of Defense. The purpose of these funds is to administer money used for the benefit of military and civilian personnel when such money is not appropriated by Congress. Although not related to logistics per se, nonappropriated funds may occasionally be the concern of logistics managers. (They also warrant brief mention in this text because they are often confused, by the uninitiated, with the reimbursement funds discussed above.)

b. The concept of the nonappropriated fund system is to supplement costs of programs initially provided, operated, and maintained through funds appropriated by Congress. Three general categories of nonappropriated funds are authorized within DOD. These are revenue-producing funds, welfare funds, and sundry or associated funds. These funds are locally self-generated and are self-sustaining. They are subject to DOD-wide uniform accounting and reporting procedures (see ARs 28-1 and 210-55).

4-24. Army Management Accounting

a. The Army accounting system is based on the conventional double-entry accrual method of book-keeping. Every financial transaction is recorded in a ledger, using the double-entry system (a debit and a credit), in accordance with the equation, assets equal liabilities plus capital plus income minus expenses. This relationship or equation forms the basic model for the formulation of the budgets, the preparation of accounting reports, and the analyses of operation in terms of financial data.

b. In addition to being a basic double-entry system, the Army accounting system is also on an accrual (as opposed to cash) basis. In accrual accounting, costs are matched with related revenue within the same accounting period. The accrual method ensures revenue will be recorded when earned, which is not necessarily the same time the revenue is received. It also provides for the recording of costs and expenses when the benefit is received. This may not correspond to the time when the bill is paid or the legal obligation is incurred. The accrual method permits income and expenses to be matched in a specific accounting period. It records events when they occur regard-

less of when funds are exchanged. The accrual system of accounting develops information on costs of goods and services used and on expenditures, disbursements, and obligations. It provides much useful data since it reflects the availability of funds and provides information on the available resources and their actual use. Cost data on the use of resources are essential to management for effective control.

c. The Army accounting system is part of the overall DOD accounting system (see AR 37-151). As such, it operates through command channels and is set up to provide a sound organizational basis for achieving the legislative objectives contained in Public Law 784, the Budget and Accounting Procedures Act of 1950, and to furnish reliable financial information required by DOD and the Office of Management and Budget (OMB). Additionally, its major objectives are to accomplish the following:

(1) Establish and maintain records and accounts of financial transactions and summaries of each accountable entry.

(2) Provide prompt and accurate payment of accounts to military and civilian personnel, contractors, and other vendors for services rendered and materiel furnished, to include the determination of entitlement.

(3) Provide the prompt collection of all amounts due DOD, the military services, or the U.S. Government.

(4) Furnish timely and accurate financial reports on the status of funds, costs, and property.

(5) Bring together all financial transactions concerned with appropriations, apportionments, allocations, allotments, commitments, obligations, receipts, disbursements, accrued expenditures, assets, liabilities, costs, revenues, and property in integrated accounting and finance systems.

d. The policy of assigning accounting functions to commands and to installations under jurisdiction of commands is based on the need to relate the functions to management responsibilities and budget administration at those levels. The entire accounting process is treated as a whole and provides a single, official set of records where it can best serve the activity that has primary responsibility. It is supported by procedures which ensure the recording of all financial transactions at the time and place they occur.

e. The structure relates the activities and records of the finance network as an integral part of the general accounting system to prevent duplication between finance activities and the installation accounting activities in recordkeeping and document handling. It also provides appropriate

relationships between the accounting and financial levels (installation, command, and both bureau and departmental headquarters) without duplication, as well as suitable accounting relationships and procedures for the control of interdependent transactions.

4-25. Integrated Accounting

Integrated accounting systems are used to cover all functions of a specific operation. They establish the broad structure of related accounts, supporting records, and control and accrual features necessary to produce the financial data required for successful implementation of the departmental financial management plan under a common set procedures. They integrate appropriation, expenditure, and financial accounting for all assets, liabilities, revenue, and costs of operations. They provide for the establishment of summary control accounts for incorporation of financial data pertaining to industrial, stock, and management funds and permit consolidation of financial statements at all echelons of command consistent with management requirements.

4-26. Decentralized Accounting

While there are variations in the application of central office accounting control, the most commonly used provides that a central accounts office maintains ledgers which summarize the total investment. The detailed recording of assets, liabilities, and fund accounts is maintained in the records at the installation where the individual transaction affecting the accounts are easily and economically available. Changes are posted periodically on the books of the accounts office from accounting statements received from the installation reporting the results of their operations.

4-27. Supporting Systems

a. *General.* The flexibility and detail necessary for accounting of the widely divergent activities within the Army are provided for by the use of a number of books of original entry and related specialized accounting procedures and systems. The summary account in the general ledger represents the sum total of these many detailed accounts. The supporting systems with their detailed accounts are covered in the following paragraphs.

b. Appropriation and fund accounting.

(1) The Army maintains a system of administrative control which restricts obligation or expenditures against such appropriation or other fund to the amount available. It fixes responsibility for violations (see AR 37-20) and provides financial

reports on the status of funds administered by the Army.

(2) Appropriation and fund accounting provides the system to accomplish these objectives. It identifies and accounts for each appropriation as a separate entity throughout its existence from time of appropriation through apportionment, transfer, allocation, allotment, commitment, obligation, expenditure, liquidation, reimbursement, or refund, or until lapsed or merged into a successor account. It is a means of providing information for budget administration and for status-of-funds reports to higher authority.

(3) Unobligated balances reported for each appropriated fund must agree with the corresponding items shown in reports on sources of funds available and obligations incurred for the respective appropriated fund. Allocation status reports for each command are prepared by consolidating the allotment of status reports of its subordinate field activities with data provided by its own accounts. In the same manner, the appropriations status reports for each department are prepared through consolidation of the allocation status reports of the major commands and bureaus with data provided by its own accounts.

(4) Commitments are recorded only when supported by documentary evidence in accordance with departmental directives. Obligations are recorded against appropriations and funds only when supported by documentary evidence in accordance with criteria contained in Army directives.

c. Expense accounting. Expense accounting procedures are designed to identify the cost of labor, materiel, and services consumed or used in carrying out the missions and programs of the Army. Expense accounting provides financial data for the operating expense budgetary requirements and related financial analyses in connection with budget administration and program management under the operating budget concept.

d. Financial inventory accounting.

(1) Operations within the Army require many categories of materiel. Aircraft, conventional ammunition, ground support materiel and missile materiel are but a few. These categories are inventory segments within the logistics support system. Such inventory must be watched carefully and maintained under strict accountability. DOD assigns national stock numbers (NSNs) for use by all military services. The national stock numbering system and Federal cataloging procedures ensure all items of supply are uniformly described, classified, and numbered.

(2) Effective management of inventories and the overall management of finances require a

carefully planned system for inventory reporting (see AR 710-1). Records are maintained of the value of receipt and expenditure transactions by class and Federal supply group (FSG). From these records, financial reports reflecting transactions and the value of inventories on hand are prepared for the ICPs. These financial records must be reconciled periodically with the individual stock record cards.

(3) Financial inventory accounting generally encompasses the acquisition, holding, consumption, and other disposition of inventories owned by the Army. This includes vehicles, tanks, aircraft, missiles, and propulsion units as well as inventories intransit, in storage, equipment in use, and industrial equipment reserve. Inventories in the hands of contractors and other military services are also included.

(4) The financial inventory accounting system uses the dollar as the common denominator to record and measure the status of supply operations by integrating or superimposing a dollar accounting system upon the item accounting system.

e. Cost accounting.

(1) Cost accounting is a system of accounting, analysis, and reporting on cost of production of goods or services and of operation of programs, activities, functions, and organizational units. The system may also embrace cost estimating, determination of cost standards based on engineering data, and comparison of actual and standard cost for the purpose of aiding cost control. The system may deal in nonfinancial (statistical) measures in lieu of or to augment financial measures. It is used when the required data cannot be obtained through general accounting processes. Cost accounting carries the classification of resources to the lowest level of detail. This extension in detail of data makes cost accounting subordinate to, and distinguishes it from, all other parts of the accounting system.

(2) Cost accounting is more specific in detail and complex in technique than the other supporting systems and is the most expensive to administer. It is designed to serve the following basic management requirements:

(a) *Measurement of performance.* Measurement of performance by cost accounting methods consists fundamentally of comparing current cost with some previously determined standard or with the results of other activities engaged in similar operations.

(b) *Determination of the amount to be charged for products furnished or services performed on a reimbursable basis.* Cost accounting provides the cost of end products or services

produced which can be used to support reimbursement billings and to establish selling prices or rates.

(c) *Budget planning, execution, and control.* Cost accounting provides detailed and specific data on past cost in a detailed classification for planning and justifying future budgets. It also provides cost of actual performance related to budgeted cost and reflects conformance of deviation from expected results.

(d) *Determination of operating results.* For activities and operations financed from industrial funds, cost accounting provides actual cost by product or service for comparison with related revenue for determination of gains or losses from operations.

(e) *Other management decisions.* Through the historical financial record of cost, accounting provides a basis for determining future cost involved in short- and long-range policy and operating alternatives, future program choices, force levels, operating levels, and operating locations and methods.

f. Real property accounting.

(1) Real property is any interest in land (including improvements of any kind, structures, and fixtures permanently located on the premises) and appurtenances to the land, under the control of the Army.

(2) Real property includes property located at defense installations, in private contractors' plants, and in other Government departments. It does not include real property items in storage. Real property is divided into four classes: land, buildings and improvements, industrial production equipment, and equipment other than industrial production equipment. It is around these classes of property that the inventory control and accounting systems for real property are built.

(3) Real property accounting includes accounting for real property in being, increases from acquisition, construction, donation and transfer in, decreases from transfer out, deletion, disposal, destruction, and for the maintenance of real property facilities. It applies to all real property as defined in pertinent military regulations including that occupied or held by contractors and occupied

by other agencies or individuals. It also includes the accumulated (incurred) cost of construction in progress being built by a specific department under a departmentally administered contract and by other military construction agencies and the Bureau of Public Roads. Real property accounting includes cost accounting for operations and maintenance of real property facilities and cost accounting for construction in progress. Real property records provide the data needed for real property reports required under law.

(4) Real property accounting also provides data necessary for examining and measuring facility plans, programs, budgets, authorizations, and cost in relation to departmental objectives by furnishing a means for effectively controlling real property facilities programs at all echelons.

4-28. References.

Army Regulations

1-1	Planning, Programing, and Budgeting Within the Department of the Army
37-20	Administrative Control of Appropriated Funds
37-24	Uniform Classification of General Ledger Accounts
37-55	Uniform Depot Maintenance Cost Accounting and Production Reporting System
37-100-FY	The Army Management Structure (Fiscal Code)
37-108	General Accounting and Reporting for Finance and Accounting Offices
37-110	Budgeting, Accounting, Reporting, and Responsibilities for Industrial Funded Installations and Activities
37-111	Working Capital Funds—Army Stock Fund; Uniform Policies, Principles, and Procedures Governing Army Stock Fund Operations
37-151	Accounting and Reporting for Operating Agencies
215-1	Administrative of Army Morale, Welfare, and Recreation Activities and Nonappropriated Fund Instrumentalities
710-1	Centralized Inventory Management of the Army Supply System

CHAPTER 5 PLANNING LOGISTICS SUPPORT FOR MILITARY CONTINGENCY OPERATIONS

Section I. GENERAL

5-1. General

a. Military planning and preparation of plans are integral parts of the sequence of actions in making and executing a decision. Not only does proper planning permit the detailed and systematic examination of all factors involved in an operation, but it also reduces the time required to make a decision when plans based on anticipated commitments are available. Planning for anticipated contingencies is normally deliberate and formal, but emergency situations may dictate an acceleration of the planning process. This chapter will address both situations by covering the joint planning process and, briefly, the Crisis Action System (CAS).

b. National military decisions are ultimately the responsibility of the President. Advice on defense matters is available to the President from the National Security Council (NSC), whose purpose is to provide a balanced, coordinated, and continuing review of military requirements in the light of current political, economic, and military considerations. National security policies, approved by the President and disseminated through military channels by the Secretary of Defense, provide the basis for the development and implementation of military plans. Since few plans call for unilateral Army operations we must become familiar with the Joint Operations Planning System (JOPS). Thus, the objective of this chapter is to introduce you to the joint planning process, the phases of planning, and the major outputs of the JOPS.

5-2. Logistics Considerations

a. Logistics plans provide the essential ingredients which make military operation plans realistic. The essence of logistics planning involves the determination of supply, services, transportation, maintenance, construction, and related logistics requirements, and the determination of existing capability to meet these requirements. It is quite evident an understanding of the basic considerations of logistics planning, defined below, is a necessary element in the development of effective planning procedures.

(1) *Leadtime*. Leadtime is considered to be the time between action taken to obtain an item for use and arrival of the item in the hands of the user.

(2) *Limited resources*. Resources (e.g., personnel, materiel, and money) are always limited. The concept of resources management used by Department of Defense (DOD) analysts recognizes this consideration by establishing throughout the Armed Forces a sys-

tem for evaluating the essentiality of conflicting defense programs.

(3) *Critical shortages*. The logistics planner and the logistics system must expect a critical shortage will develop and extraordinary and emergency measures must be taken to correct the shortage.

(4) *Priorities-allocations-reserves*. Since resources are always limited, systems of priorities and allocations are established reflecting command judgments of military value or essentiality. The basic point of this logistics consideration is, once a system is established, discipline is necessary to prevent frustration of the system.

(5) *Underplan-overplan*. Underplanning, whether a result of poor estimates, misunderstanding, improper application of good planning factors, or proper application of poor planning factors, creates a critical shortage which eventually manifests itself in overplanning.

(6) *Coordination-communication*. Constant exchange of information and coordination, with real communication and understanding, are vital to the command so all elements of command can bring about military success.

(7) *Flexibility*. Regardless of the level at which planning is conducted, it must, provide for the means to be in place to carry out the commander's decision. The plan must also provide for enough flexibility to permit the commander and the staff to meet various situations which may arise as the result of an action by an opponent.

(8) *Adequacy-suitability-feasibility*. The courses of action open to a commander to meet the situation which exists, or might develop, must be considered in terms of adequacy, suitability, and feasibility.

(9) *Command control*. Each of the foregoing logistics considerations alluded to the key fact that command control must be exercised with sound judgment, understanding, competence, and restraint. Unless positive command control is maintained, the various logistics installations and operations tend to expand to unmanageable size. Logistics discipline can only be exercised as a function of command.

b. The logistics planner must be skilled in the use of appropriate tools. Accurate, complete, and timely logistics information is one of the essential planning tools. Logistics estimates and logistics plans are dependent on availability of readily usable information

and planning factors and on the skill and judgment with which these are used by the planner to solve military problems successfully.

(1) Planning factors are based on experience, either peacetime or wartime, and are used to forecast future requirements. Their accuracy will vary either because conditions in the area in which they are being applied differ from those in the area in which the experience was accumulated or because of changes in operating techniques.

(2) Staff planning factors, while essential tools, should be used with a clear understanding of their capabilities and limitations. For example, a staff planning factor for ammunition expenditure by a tank battalion in an offensive operation normally would not be employed by planners on the division staff in estimating requirements for a specific operation. The reason, of course, is this particular staff planning factor is broad, based on average conditions over a series of operations. Detailed logistics requirements should, when practicable, be based on a thorough study of the specific operations to be conducted.

(3) Logistics planners should accumulate new information within the area of operations, analyze it, and translate it into new planning factors which may supplement or replace older factors. Normally, experience should soon build up planning factors which are either generally applicable or applicable to specific types of operations.

5-3. DOD and Joint Chiefs of Staff (JCS) Guidance

a. DOD policies and guidance are published in the Logistics Planning and Programming Guidance (LPPG) section of the Secretary of Defense Planning and Programming Guidance Memorandum (PPGM), DOD directives, DOD instructions, or other transmittals.

b. To ensure a worldwide readiness capability to meet the needs of the U.S. and allied forces in a national emergency, an industrial base which can be quickly and effectively mobilized to support minimum essential long-range production requirements is of major importance. DOD is charged with providing for a sustained state of industrial preparedness for production of essential military items through continuous planning for production of essential items identified and selected by the military departments. DOD is also charged with ensuring that an adequate commercial maintenance/repair capability exists to meet readiness requirements for items of materiel included in the approved forces but not supported by an organic depot maintenance capability.

c. DOD planning policy provides for the application of controls on the economy to channel industrial effort from commercial to emergency support activities. It also considers measures to minimize leadtime and to maintain industrial base facilities in a high state of readiness and realistic determination of total production requirements needed to support forces approved for mobilization.

d. Each DOD component is required to establish and maintain a war reserve program. It is DOD policy that DOD components select items for war reserve to initially sustain, in wartime, all necessary combat and combat support operations and the expanded logistics system required to maintain these operations.

e. The Secretary of Defense has assigned to the JCS certain responsibilities for the direction and control of the military services and those joint commands established by the President. These responsibilities are enumerated in DOD Directive 5100.1, "Functions of the DOD and Its Major Components," and in JCS Pub 2, "Unified Action Armed Forces (UNAAF)." The logistics responsibilities assigned to JCS of interest to the logistics planner include the preparation of joint logistics plans and mobilization plans and assignment of logistics responsibilities to the military services and the Defense Logistics Agency (DLA) to carry out those plans. JCS provides guidance to the military services to the commanders of unified and specified commands for the development and execution of general war and contingency plans. Basic logistics responsibilities for such planning are stated in JCS Pub 2, "Unified Action Armed Forces," JCS Pub 3, "Joint Logistics and Personnel and Policy Guidance," JCS Pub 15, "Mobility System Planning Compendium," and in volumes I and II of the "Joint Operations Planning System (JOPS)." JCS reviews the plans developed by the unified and specified commands for adequacy, feasibility, and suitability. JCS also reviews the major logistics requirements of the military services in relation to all strategic plans.

f. The unified command plan is the basic document which establishes the unified and specified commands. This plan is approved by the President and delineates specific geographic areas of responsibility to commanders around the world. The plan also assigns primary tasks, defines authority of the commander, establishes command relationships, and provides guidance on the exercise of operational command. The unified commanders prepare for contingencies in their assigned geographic areas where there is a logical threat or mission and plan for control of forces being deployed to their areas as they enter the area. Under the present

plan, not all geographic areas are covered by unified or specified commands. In those areas the planning is assigned to the U.S. Readiness Command (USRED-COM) or is undertaken by JCS. The assigned areas

are those which have the highest risk of a threat, will best implement U.S. military strategy, are the current location of U.S. forces, or involve agreements with allies.

Section II. JOINT PLANNING

5-4. Joint Operation Planning System

a. Military planning for the accomplishment of an assigned task(s) is a continuous process. It begins when the task is assigned and ends only when execution is ordered and the mission is accomplished or the requirement for the plan is canceled.

b. Once developed and approved, the plan must be maintained in a current status. The plan should be revised, changed, or otherwise modified anytime the prevailing circumstances, forecast situation, or availability of forces or resources dictates. The prevailing circumstances reflect national objectives, the political and economic environment, adjustments in threat estimates, and/or new developments. Changes in force and resource availability may result from adjustments in priorities, alteration of the force structure, or modification of the national strategic reserve inventory. In addition to the requirement for updating plans on an ad hoc basis, JCS requires an annual review of existing plans. Command unique requirements for the periodic review of existing plans are contained in local instructions.

c. The only certainty in the world environment is there will be change. Threat estimates, force and resource allocations, and a wide variety of other significant planning criteria are forecast. Such forecasts may be enlightened, but are not infallible. Even though an existing operation plan is valid in light of the forecast, the existing operation plan must be adjusted to the reality of the prevailing circumstances at the time of execution and must be translated into an operation order (OPORD) which can be implemented. Within the context of JOPS procedures, the planning cycle provides for the tailoring, expansion, and further development of such operations plans as may exist, and for their translation into an operation order. Additionally, the CAS within the planning cycle will accommodate the emergency development of an operation order to fulfill an operational requirement for which no plan exists.

d. To assist them in exercising their function of providing "strategic and operational direction to unified and specified commanders," JCS established the Joint Strategic Planning System (JSPS). It consists of seven documents prepared and maintained by JCS. These documents are used to provide military advice on military strategy and force structure to DOD and to assign planning tasks and planning guidance to unified

commands (Readiness Command, Atlantic Command, Central Command, European Command, Pacific Command, and Southern Command), specified commands (such as Military Airlift Command (MAC), Strategic Air Command (SAC), and Aerospace Defense Command), and to the services (Departments of the Army, Air Force, Navy, and U.S. Marine Corps staffs). The JSPS document which assigns planning tasks and provides planning guidance is the Joint Strategic Capabilities Plan (JSCP). The JSCP also includes listings of major combat forces and the numbers and types of strategic lift assets available for planning purposes. Planning tasks identified subsequent to publishing of the JSCP and those required for emergency/crisis situations are transmitted by means of JCS planning directives. Although there are no set formats for these planning directives, they are usually detailed documents and contain all of the information available to the JCS at the time the tasks are identified. The means most likely to be used to provide the initial guidance are the JCS Warning Order for crisis situations and the JCS Letter of Instructions for other situations. Once a planning task is received by the joint command which is designated by JCS to develop the plan, it is translated into an operation plan (OPLAN) or conceptual plan (CONPLAN) using the guidance specified by the JOPS and following a systematic planning sequence called the Joint Planning Process.

e. The Joint Planning Process is a coordinated staff procedure used to determine the best method of accomplishing assigned tasks and to direct the action necessary to accomplish the mission. It is a systematic process consisting of seven phases (para 5-4 i through 5-4 o) and is used to translate broad planning tasks into feasible plans. The two types of plans with which we are concerned are the OPLAN and the CONPLAN. The OPLAN is complete with all annexes and appendixes which can be translated into an operation order with minimum changes. OPLANs are normally developed for situations which will require maximum use of forces and logistics or mobility resources available and in instances where the OPLANs are likely to be executed. The CONPLAN is in abbreviated format requiring expansion to an OPLAN or an operation order prior to execution. Guidance as to whether a plan is to be an OPLAN or a CONPLAN is contained in the JSCP. In addition, two terms commonly used

to refer to major joint commanders are "supported CINC" and "supporting CINC." The commander of a unified or specified command is called the supported commander in chief (CINC). The supported CINC is the commander responsible for the development and execution of an OPLAN. The supporting CINC is the commander who provides forces and/or services to the supported CINC to satisfy OPLAN requirements.

f. Administrative procedures, plan format, and data exchange are formalized and standardized through instruction and guidance contained in a four-volume JCS document titled JOPS.

(1) Volume I provides guidance and administrative procedures for the development, coordination, dissemination, review, and approval of joint plans. It prescribes standard formats and minimum content of operation plans, annexes, and appendices. JOPS I also contains procedures for translation of OPLANs to OPODs.

(2) Volume II is a classified document. Its content is functionally oriented and provides guidance for the development of the classified annexes of the OPLAN.

(3) Volume III describes the standard automatic data processing (ADP) application programs and data files which are available to the planner for structuring a force and testing an OPLAN for logistics feasibility. It also describes the interaction of these programs and data files and provides examples of outputs available to the planner. A more detailed description of JOPS III is found at 5-4k(2)(a).

(4) Volume IV is titled the "Crisis Action System." It outlines by phases the procedures to be followed for development of OPLANs involving the use of military forces in emergencies or in time-sensitive situations. JOPS IV also provides examples of JCS Warning Orders, JCS Alert Orders, and commander's operation reports (OPREPs) to be used under these conditions.

g. The JOPS system formalizes and standardizes administrative procedure, data exchange and storage, and plan format. JOPS is used in contingency planning where planning for the deployment of forces is the prime concern. There are several elements associated with the joint planning process which play an essential role in operation planning. Some of these are explained below:

(1) The Joint Reporting Structure (JRS) is the approved reporting structure in which information, direction, and response regarding military operations are documented for transmission from, to, and between commanders. Data in JRS format are exchanged in the worldwide military command and control system (WWMCCS).

(2) WWMCCS is a DOD-approved network of command and control systems and subsystems. It con-

sists of facilities, equipment, procedures, and personnel essential to a commander for conveying data used in planning, directing, and controlling military operations. Capabilities include TELENET, TELECONFERENCE, and SENDFILE.

(3) The unit status and identity report (UNITREP) is the automated reporting system within DOD through which authoritative basic identity and status information concerning force units and organization is provided to the National Command Authorities (NCA) and JCS. Units are designated for deployment on the basis of their readiness posture in UNITREP. In addition, the UNITREP report contains basic identity, general status, personnel strength, combat readiness, equipment and crew status, and other elements that present a picture of the unit and its daily readiness and capabilities.

h. The joint planning process describes an orderly flow of actions in the development of an OPLAN from the initiating event, through concept and plan development, and up through review, analysis and preparation of supporting plans and CAS phase. The culmination of the process is the implementation of the OPLAN. The joint planning process is schematically displayed at figure 5-1.

i. The first phase is initiation. This is the phase in which planning tasks are assigned, forces and resources available for planning are identified, and the stage is set for planning. The receipt of the JSCP or other planning directives by the supported CINC completes the Initiation Phase. Planning guidance provided by JCS in the JSCP is applicable to all planning requirements regardless of their origin, unless otherwise stated or additional information is provided by JCS. The JCS through the JSCP:

(1) Provides strategic guidance and intelligence.

(2) Assigns tasks to the unified and specified commanders.

(3) Identifies major combat forces (by type, quantity, and availability) which are available for planning.

(4) Identifies JCS-controlled resources which are available for planning.

(5) Identifies the depth of planning required; i.e., requirement to development OPLAN or CONPLAN.

(6) Assigns priorities.

(7) Provides guidance to the services for logistics support of JSCP forces.

j. The objective of the second phase, concept development, is to derive the concept of operations. In this phase, all factors which may impact on mission accomplishment are collected and analyzed, the best course of action is determined, and the concept of operation is designed. The concept of operations is an expansion of the selected course of action into a broad narrative statement of how the supported CINC ex-

THE PLANNING PROCESS AND ADP SUPPORT

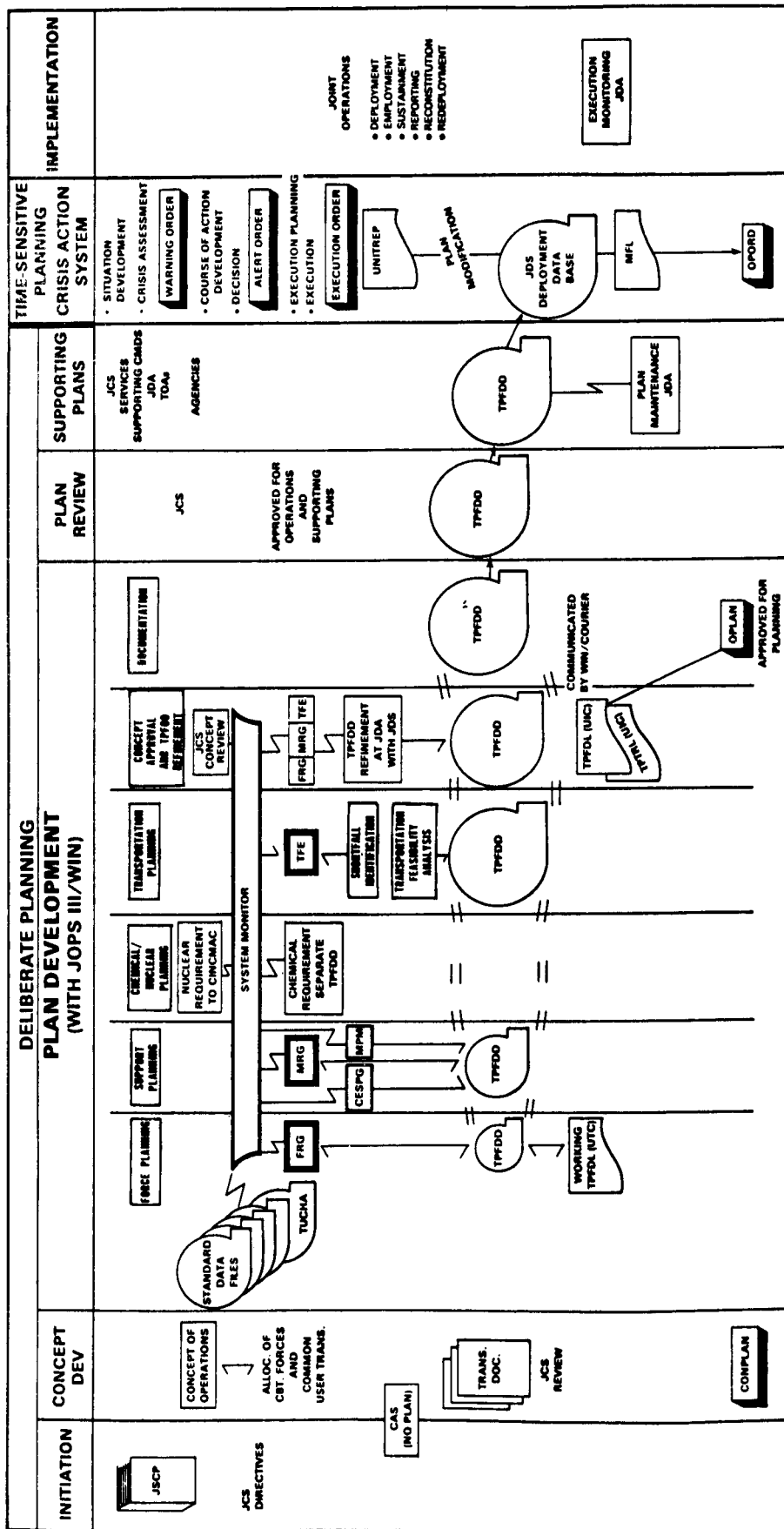

Figure 5-1. Phases in joint planning.

pects the operation to unfold. Concept development is a function of the unified commander's planning staff and, while constant interaction exists with the service components, the steps we will discuss to arrive at the concept of operations are accomplished by the unified commander and staff. Service components do not have a formal role during the Concept Development Phase, but provide the unified commander with advice on service-related matters. The Concept Development Phase consists of five steps; however, it should be kept in mind, in actual practice, concept development will not take place in clearly defined steps. There will be occasions when two or more steps are in process concurrently. It is also possible the results of preliminary work on one step will be used in the reworking of an earlier step. Concept development begins when the joint commander is assigned or determines a planning requirement (Phase I—Initiation) and ends with an expansion of the selected course of action into the formal concept of operation. Sequentially, the steps involved are:

- (1) Analysis of missions and tasks.
- (2) Issuance of preliminary planning guidance by the commander.
- (3) Preparation of staff estimates.
- (4) Preparation of the commander's estimate and decision.
- (5) Preparation of the concept of operations.

k. Phase three, Plan Development, is the procedure where ADP can be used to determine how best to support the commander's concept of operations. ADP data files and application programs support can be obtained thru the WWMCCS.

(1) The objective in this phase is to develop a feasible plan. The Plan Development Phase begins when the supported CINC provides the service components and supporting commands and agencies with the concept of operations, and it ends when the plan has been documented in the format and detail is required by JOPS. During this phase of the planning, the subordinate component commanders determine their specific force requirements, supply requirements, personnel replacements, and the recommended time phasing of these assets so they arrive in the area of operations when they are needed.

(2) In Phase II—Concept Development, the planning activities were accomplished within the joint planning staff with little formal participation by components or supporting commands. However, in the Plan Development Phase, the supported CINC'S role is of a consolidator and review authority. The bulk of the responsibility for detailed data generation to support the concept of operations is in the hands of the service components and supporting commands. As indicated, plan development uses ADP support. An outline

knowledge of the support available to the planner is necessary before considering the steps involved in plan development.

(a) The JOPS III software consists of two basic packages: standard application programs and standard data files. Standard data files are the data files used most commonly by the planners. A sampling of these files with their ADP name includes:

- 1 Transportation assets file (ASSETS).
- 2 Characteristics of transportation resources file (CHSTR).
- 3 Port characteristics file (PORTS).
- 4 Aerial ports file (APORTS).
- 5 Type unit characteristics file (TUCHA).
- 6 Status of plans file (RPLN).
- 7 Civil engineering files (CEF).
- 8 Logistics factor file (LFF).
- 9 Geolocation file (GEOFILE).
- 10 Type unit equipment detail file (TUDET).

(b) Along with the standard data files, JOPS III employs a series of major application programs. A brief description of selected major application programs follows:

1 Using a conversational dialogue, the *system monitor* provides the planner the capability to communicate with other JOPS software programs. This is accomplished with a set of preprogrammed questions.

2 *The force requirements generator* (FRG) permits the planner to select, analyze, and tailor a variety of force options and to produce an acceptable deployment scheme. The FRG is a set of programs serving as an automated instructional manual presenting a terminal display of data instructions and alternatives. The FRG is used extensively during the first two steps of plan development in coming up with the component force list and time phasing the deployment in accordance with the concept of operations. The major output generated by the FRG is the time-phased force and deployment list (TPFDL).

3 *By accessing the movement requirements generator* (MRG), the planner expands the force deployment data through computation of additional movement requirements. The MRG provides a capability to generate gross nonunit-related cargo and replacement personnel requirements based on the forces to be supported and the duration of the planned operation. After the total movement requirements have been identified, a test to determine feasibility is required.

4 *The transportation feasibility estimator* (TFE) supported by standard distance software, compares movement requirements of deploying forces, supplies and equipment, and replacements with available transportation resources. In addition, the TFE analyzes the reception and discharge capabilities of

airfields and seaports. Successive iterations of the program coupled with modifications to the original deployment scheme will result in a feasible OPLAN based on the optimum movement of the forces and cargo involved. The major output of the TFE is the time-phased transportation requirements list (TPTRL).

4 A *civil engineering support plan generator* (CESPG) and *medical planning module* (MPM) are also available to assist the planner in computing unconstrained facility requirements as well as medical requirements.

(3) Having described the JOPS III ADP support, it is now possible to move through the Plan Development Phase using these programs. To provide a clear understanding of the Plan Development Phase, it will be discussed in eight sequential steps. During the discussion, keep in mind the interdependence of these steps and the fact that results of one step may impact on and cause a revision to a previous step.

(a) The first step in plan development is force planning. Force planning is keyed to the supported commander's concept of operations, based on service doctrine and governed by guidance and constraints received by the service component commanders in both joint and service channels. It consists of determining force requirements, developing force lists and refining in light of force requirements, developing force lists and refining in light of force availability, and identifying and resolving force shortfalls. The purpose of force planning is to identify and time-phase the total forces needed to support the CINCs (supported commander's) concept of operations. The service component commander's planners may do this in several ways using one of the major application programs. They can select units from the type unit characteristics TUCHA file and build a force list unit by unit using their experience and service planning factors, or, they can use the FRG to build a nonstandard unit. Finally, the planner may select a force package that he has used on a similar operation or had developed previously. These forces are then stored in the time-phased force deployment data (TPFDD) file. The supported commander's major force list is expanded and time-phased into the area and required combat support and combat service support units are added to the major force list and also time phased. These force lists are reviewed and approved in both joint and service channels for adequacy and force availability. The service component commanders use the FRG to phase forces to support the concept of operations. To accomplish this, the planner must establish the following data for each unit on the force list which includes:

- 1 Port of embarkation (POE)/port of debarkation (POD).
- 2 Mode of transportation.

3 Source of troops.

4 Latest arrival date (LAD).

5 Priority (tithing LAD).

Note: A complete list of requirements is found in chapter II, JOPS volume I.

After the planner has entered these data for each unit, the FRG can be put in the execute or compute mode to get output. The primary output associated with this step is the TPFDL which lists the forces arriving in theater on the dates and in the order specified by each planner. This step concludes with the production and approval of the actual force list (TPFDL).

(b) The second step in the Plan Development Phase is support planning. In this step the service components determine the time-phased support requirements necessary to sustain their forces in combat. This entails computing support requirements based on service planning factors and time phasing of this support in accordance with the unified commander's overall concept of logistics support to ensure uninterrupted support of combat operations. Support requirements include supplies, equipment, materiel, and replacements for support of assigned forces, civil engineering support materials, medical materials, and equipment and supplies to support civil military operations. Support planning can be accomplished in one of two ways. First, the service component computes its own support requirements and forwards them to the supported commander for consolidation. Whenever the delivery date of a force has to be changed to eliminate constraints when the TPFDL is integrated, the supply requirements for that force must also change, thus requiring additional MRG runs. The second method requires the service component to forward the TPFDL and the planning factors (pounds/man/day) for all classes of supply. The supported commander then consolidates the components' TPFDLs and executes support planning against the integrated force list using service component planning factors. Thus, the unified commander consolidates or computes the service component support requirements. In force planning we developed the transportation requirements for units. In support planning, transportation requirements for all the materiel to support these units are determined. The major objective in this step is to identify and time-phase support requirements for the entire operation.

(c) The third step is nuclear, biological and chemical (NBC) planning. This step consists of chemical/biological (CB) planning and nuclear planning. The NBC planning process requires the component commanders to submit their chemical requirements to the supported commander who consolidates these submissions into a single time-phased list and prepares a sep-

arate TPFDD. During the nuclear planning process, the supported commander will again consolidate nuclear requirements and these, when time phased, will be passed to the MAC for incorporation in the appropriate CINCMAC OPLAN.

(d) The fourth step is transportation planning. This step in the Plan Development Phase is directed toward solving the complex strategic movement problem. It addresses both intertheater and intratheater movement and includes loading, moving, and receiving manpower, materiel, and equipment between the POE and the POD. In transportation planning, competing requirements for strategic lift resources, mobility support facilities, and intratheater transportation assets must be assessed in terms of impact on mission accomplishment. Priorities must be established and a movement program finalized in light of both movement constraints and the concept of operations. Once determined feasible, the movement program serves as the foundation for developing preliminary movement tables and schedules produced during the supporting plans phase.

(e) The fifth step in plan development is force, movement, and support shortfall identification. Even though we place it sequentially in a given position, in actuality it is conducted at all levels and during each step of joint planning. The primary method for handling shortfall identification reporting and resolution is the plan development conference. The plan development conference is to resolve shortfalls and limiting factors and to finalize the TPFDD. In the event the assembled group of experts at the plan development conference cannot resolve shortfalls and limiting factors, they will be reported to JCS as shortfalls for resolution in coordination with the services. Shortfalls could be in the areas of forces available, transportation, logistics support, etc. Reported shortfalls must be accompanied by an assessment of associated risk. Listed below are some of the options available to the supported CINC to resolve any problem area before reporting it to the JCS.

- 1 Refine priorities.
- 2 Adjust POEs, PODs, routing and/or timing.
- 3 Change lift mode.
- 4 Adjust pre-positioned forces/resources.
- 5 Enhance preparedness with base development and civil engineering support.
- 6 Seek additional assets.
- 7 Redefine concept of operations.
- 8 Submit plan with unresolved shortfalls.
- 9 Employ combination of above.

Shortfalls and limiting factors, together with the recommended solutions which are given to JCS for resolution, will be resolved by JCS in coordination with

the appropriate service department. On receipt of the JCS decisions, the supported CINC can then finalize the TPFDD.

(f) The sixth step is the transportation feasibility analysis. The joint planner has been conducting feasibility studies with the TFE continually during the planning process and during the plan development conference as shortfalls and limiting factors are discovered and resolved. All the assembled data have to be examined closely to ensure that the necessary changes have been made to forces, support, and transportation assets, since any changes in the fifth step will impact throughout the steps of plan development. When decisions are reached at the plan development conference, the planner must implement those decisions, retest them for feasibility with the TFE, and finalize the TPFDD.

(g) The seventh step in the plan development phase is concept approval and TPFDD refinement. This requires initial documentation of the plan and initiation of the JCS review of the concept of operations. Ninety days prior to the due date specified in the JSCP, the supported commander will forward the OPLAN in concept format (with its initial TPFDD) to the Joint Deployment Agency (JDA), supporting commanders, and the Transportation Operating Agencies (TOAs) to permit preliminary movement planning and documentation for TPFDD refinement and to the JCS for adequacy review. Within 30 days after receipt, the JCS will review the concept for adequacy and respond. This review determines whether the scope and concept of planned operations are sufficient to do the assigned task. It is fully coordinated by all appropriate organizations (e.g., JCS directorates, service, and outside agencies) so that TPFDD refinement can proceed. JCS approval will be "for further planning only." Following review of the TPFDD by the supporting commanders and TOAs, the JDA will manage a TPFDD refinement conference for the supported commander. The purpose of this conference is to coordinate actual data into the TPFDD and to resolve force, personnel, and resupply shortfalls, if possible. Conference participants should include representatives of the supported commander, Joint Staff, services, supporting commanders' agencies, and the TOAs. Upon completion of the conference, the TPFDD, insofar as possible, will contain actual unit data and actual movement requirements. The TOAs will now use the TPFDD for feasibility testing and the production of movement schedules/tables. The JDA will convene a second TPFDD refinement conference after the TOAs have completed their coordination and analysis. The purpose is to coordinate the combined transportation requirements and shortfalls with the supported commander, incorporate movement schedules and tables into an operation plan deployment data

base, and coordinate approval of the TPFDD closure file by the supported commander. As a minimum, conference attendees will include representatives of the supported commander, JDA, and the TOAs. At the completion of this conference, the refined TPFDD and movement schedules/tables will be transferred to the OPLAN deployment data base. The first 15 days of movement from origin will be intensively managed to ensure continued accuracy. Following JCS concept approval or directed revision, TPFDD refinement, and movement coordination, the supported commander will complete the detailed appendices required for an OPLAN and prepare the plan in accordance with prescribed format for submission and final approval.

(h) The final step in plan development is plan documentation. It involves documenting (by the supported commander) the basic plan, all required annexes, the TPFDD, and the CESP in the prescribed format, and submitting the plan to the next superior in the chain of command. Plan documentation as addressed in this step does not include documenting supporting plans since this function follows plan review. Data developed in all previous steps of joint planning is used here. The ease with which plan documentation is accomplished depends on the quality and completeness of the foregoing steps. The documentation of a specific element of the plan may begin any time the assembled data are adequate to serve as a basis. However, it cannot be finalized until all plan data has been assessed and tested as an entity and the concept of operations (e.g., employment, deployment, and support) has been determined to be feasible. Format guidance relative to their content, and administrative instructions for their use are contained in JOPS manuals and JCS publications. Completed OPLANs are submitted to the appropriate superior in the chain of command for review and are distributed to subordinate and supporting commands and agencies to use in developing required supporting plans. Plan submission and distribution instructions are contained in chapter II of JOPS, volume I.

1. The objective of the fourth phase of joint planning, plan review, is to obtain approval of the plan. All OPLANs prepared to fulfill planning tasks assigned in the JSCP, or otherwise assigned or approved by JCS, must be submitted to JCS for review. Plan review is initiated on JCS receipt of a hard-copy OPLAN which has been developed by a unified commander. Plan review is conducted to determine the adequacy, feasibility, and suitability of OPLANs; to validate assumptions; and to identify force shortfalls and limiting factors in order to accomplish the mission assigned.

(1) In reviewing for ADEQUACY, the OJCS must determine whether the scope and concept of planned

operations are sufficient to accomplish the tasks that have been assigned.

(2) In reviewing for FEASIBILITY, the OJCS must determine whether:

(a) The assigned tasks could be accomplished by implementing the plan.

(b) The force, transportation, logistics resources, and support required to execute the plan can be provided.

(3) In reviewing for SUITABILITY, the JCS must determine whether the plan:

(a) Can be adapted to the range of circumstances which could require the implementation of the plan.

(b) Effectively uses the forces and resources which have been made available for planning.

(c) Provides for the employment of combat and combat support operations appropriate to the type and scale of the threat envisaged.

The fourth phase also includes services and appropriate Joint Staff directorates review to determine if the OPLAN can be supported logistically and all necessary supporting forces are included.

m. Phase five of the joint planning process is supporting plans. Supporting plans are those plans which are needed by commanders to provide necessary direction to their command to accomplish the tasks assigned by the unified commander (supported CINC) in the OPLAN. The supported CINCs service components and subordinate joint task force (JTF), if activated, and supporting commanders may find it necessary to develop supporting plans. For academic purposes, supporting plans can be broken down and discussed as deployment plans and employment plans. Deployment plans are prepared by supporting CINCs and component commanders to move augmentation or assigned forces to the supported commander's employment area. These plans will normally carry the plan identification number (PIN) of the supporting CINC and the plan summary will identify the OPLANs which the forces support. Employment plans are of primary interest to the command and control agency tasked to implement the OPLAN, such as a JTF or subordinate unified command. In the absence of an activated JTF, each service component of the supported CINC would develop employment plans for its respective service forces. During this phase, the TOAs prepare preliminary movement tables. These are detailed transportation movement plans for moving personnel and materiel from their point of origin to the operational area. When the supported CINC receives the required supporting plans, the basic OPLAN is ready for execution.

n. CAS is the sixth phase of the joint planning process. In this cycle, an OPLAN or concept of operations is modified and translated into an active directive such

as an OPORD. Preliminary to the issuance of the OPORD, JCS initiates this phase by preparing and disseminating an alert order. The alert order normally contains information concerning the situation, mission, response desired, force and resource allocation data, and target dates. After analyzing the alert order, the supported commander determines whether there is an existing OPLAN or CONPLAN to cover the situation. If an OPLAN exists, identification of actual forces and logistics assets by the component commanders and development of movement schedules by the transportation operating agencies is all that is required. If no OPLAN exists, perhaps expansion of a CONPLAN will suffice or in the absence of a CONPLAN all phases of the planning process must be accomplished. In summary, CAS phase includes the following steps:

- (1) Situation Development.
- (2) Crisis Assessment.
- (3) Course of Action Development.
- (4) Decision.
- (5) Execution Planning.
- (6) Execution.

o. The last phase of the joint planning process is implementation. The Implementation Phase is the part of joint planning in which military action is initiated, operations are monitored, and plans are adjusted to fit the evolving situation. It begins when the National Command Authority decides to employ U.S. military forces and ends when the assigned mission has been achieved and U.S. military forces have been withdrawn from the operating area.

5-5. Plans of the Commanders of Supported Unified or Specified Commands

a. OPLANs of the supported unified/specified commands include, as part of these plans, the commander's concept for providing logistics support for conducting the tactical operations. This concept should describe and define command responsibilities, functional alignments, and assignment of logistics support tasks in sufficient detail to permit developing detailed logistics support plans and to ensure that all essential logistics tasks and evaluations required are provided for.

b. It is essential that logistics and operation planning be conducted concurrently during the development of TPFDLs. This planning should ensure the adequacy of lines of communications, facilities, combat service support units, and logistics resources to support the planned force buildup. Other support problems are identified and resolved prior to the implementation of the plan.

c. Logistics plans of the supported command should, to the extent required, address time phasing, pre-po-

sitioning and priorities for materiel, lines of communication, availability and allocation of transportation resources, the coordination and control of movements, interservice support, communications, and other significant items which would influence logistics support.

5-6. Role of the Supporting Unified Command

a. OPLANs of the oversea unified commands may require that assigned forces be augmented by forces of another oversea unified command or by the U.S. based forces of USREDCOM. These designated supporting commanders receive guidance from the supported commanders OPLAN for developing their supporting plans. Generally, the guidance provided by the supported unified commander is quite broad. The interests of the supported commander generally involve the numbers of people and the short tons of supplies and equipment to be moved into the operational area within a given time frame and within available transportation resources. The supporting commander or planning agent must translate this broad guidance into detailed force requirements, force routing data, movement procedures, logistics support assignments and procedures, and necessary guidance for use by subordinate commands and other supporting commands, agencies, and activities for developing their plans.

b. USREDCOM is the principal supporting unified command. The major mission of USREDCOM is to exercise continuous operational command over all U.S. Army and U.S. Air Force general-purpose forces based in the Continental United States (CONUS) which are not assigned to other unified and specified commands, USREDCOM is not responsible for the conduct of operations but for the readiness and deployment of combat forces to reinforce other unified commands.

c. The Army component of USREDCOM, the Army Readiness Command (ARRED) is made up of forces of the U.S. Army Forces Command (FORSCOM). FORSCOM is also the Army component of the U.S. Atlantic Command (LANTCOM).

d. Acting as the commander of the Army component for two unified commands (Readiness Command and Atlantic Command) the Commander, FORSCOM, develops plans to support the OPLANs of these unified commands. This planning includes the selection of available units to fulfill force requirements and the determination of movement requirements for each troop unit selected. Through the use of computer support provided by the WWMCCS, FORSCOM can accomplish the two parts of the assigned mission.

5-7. Role of the Department of the Army

a. As discussed previously, the employed forces are under the operational command of the unified and specified commands. The major combat elements of these forces are allocated for planning purposes to these operational commands through joint channels. Combat support and combat service forces required to enhance the combat effectiveness of the major combat forces, to maintain a sustained combat capability and to provide the essential support services are allocated by the military services. The military services are responsible for the administration of their components except for the exercise of operational command/control. The responsibilities of the services include the provision of filler and replacement personnel and providing adequate logistical support for operational forces assigned to unified commands. The services are also responsible for determining the total logistics support required to active U.S. forces and those planned to be mobilized or activated to support the operational commander's OPLAN. The services review the unified commander's OPLANs to determine force availability and force list balance, the adequacy and feasibility of logistics support, and to assess their capabilities to provide logistics support.

b. The Department of the Army (DA), in carrying out its responsibilities, has delegated planning authority to Army component commands of unified commands and joint forces and to other major Army commands (MACOMs). HQDA Staff sections provide policy and procedural guidance to the Army component and other major Army commanders. These policies and procedures relating to the logistics aspects of joint planning include:

- (1) Funding guidance.
- (2) Planning factors.
- (3) Establishment of theater stockage levels.
- (4) Base development policies.
- (5) Strategic mobility planning.
- (6) Force structure.
- (7) Establishment of priorities for logistics resources controlled by DA for initial support of deployed/employed forces.
- (8) Single supply pipeline system.
- (9) Management of war reserve stocks.

c. Army mobilization planning and Army participation in joint operations planning must be closely coupled and integrated processes. The Army aspects of joint planning are based on, and constrained by, the capabilities of mobilized Army forces. Conversely, Army mobilization must satisfy

the requirements for forces and resources defined in joint operations planning. The Army Mobilization and Operations Planning System (AMOPS) recognizes this close, complex relationship and provides the means for Army participation in joint operations planning and for Army mobilization planning.

(1) The objective of AMOPS is to improve Army participation in joint operations planning and Army mobilization planning and execution through—

(a) More clearly defined responsibilities and more disciplined procedures for the conduct, of planning actions and execution.

(b) Centralized planning management.

(c) A single-source document set for promulgation of policies, guidance, and planning assumptions concerning the short-range strategic employment, mobilization, and deployment of Army forces.

(2) The Army Mobilization and Operations Planning System (AMOPS) is the vehicle by which all components of the Army plan and execute actions to provide and expand Army forces and resources to meet the requirements of unified commands. AMOPS serves as the Army supplement to the Joint Operation Planning System (JOPS). It provides the interface between unified command plans for deployment, and utilization of forces and Army plans for providing mobilized forces and resources. AMOPS consolidates policies and procedures, defines responsibilities, and provides operational planning guidance related to mobilization and the strategic employment of Army forces.

(a) AMOPS consolidates policies and procedures, and defines responsibilities for Army participation in the development, coordination, dissemination, review, and approval of joint operation plans and for Army participation in the Joint Operation Planning System (JOPS) and the Joint Deployment System (JDS).

(b) AMOPS provides operational planning guidance for the short-range strategic employment of Army forces under both mobilization and non-mobilization conditions.

(c) AMOPS consolidates policies and procedures, and defines responsibility for the development, coordination, dissemination, review, and approval of Army mobilization plans and for planning for the execution of those plans.

(d) AMOPS formalizes and documents functional information requirements for mobilization/deployment planning and execution as a basis for developing improved automated systems.

(3) The set of AMOPS documents which defines the Army Mobilization and Operations Planning System is described as follows:

(a) *AR 500-5. The Army Mobilization and Operations Planning System.* AR 500-5 establishes the AMOPS, defines the purpose of the system, identifies proponents for maintenance of AMOPS documents, and directs preparation of mobilization plans constituting the Army Mobilization Plan.

(b) *AMOPS I, System Description, Responsibilities and Procedures.* AMOPS I describes the AMOPS documents, prescribes responsibilities for their maintenance, and outlines the mobilization process including actions at OJCS, HQDA, and MACOM levels. It describes the interrelated processes of mobilizing units, individuals, and materiel, and of expanding the CONUS sustaining base.

(c) *AMOPS II, Strategic Employment of Army Forces.* AMOPS II describes the Army's capability to meet the tasking requirements of the Joint Strategic Capabilities Plan (JSCP) within current program and budget limitations.

(d) *AMOPS III, Army Mobilization and Employment Planning Guidance.* AMOPS III contains basic guidance for the mobilization of Reserve Component forces, their assimilation into the active component, and the equipping and training of units and individuals; it also contains guidance for forces and individuals designated to deploy to an overseas theater of operations.

(e) *AMOPS IV, Army Crisis Action System (ACAS).* AMOPS IV prescribes ARSTAF crisis organization, staffing methods, emergency action procedures, and JCS interface during a crisis.

(f) *The Army Mobilization Plan (AMP).* The Army Mobilization Plan is the collected mobilization plans of HQDA and the MACOMS. AR 500-5 directs the preparation of mobilization plans or files at every level from MACOM to unit and prescribes the minimum plans included in the AMP.

5-8. Role of the U.S. Army Materiel Command (AMC)

a. The assigned mission, in brief, charges the Commander (CDR), AMC to furnish timely and effective supply and maintenance support to the Army. The CDR AMC has been designated by DA as the DA coordinating authority for the provision of pre-planned supply support (less accompanying supplies and medical supplies) to U.S. Army forces designated to support an approved OPLAN. The CDR AMC has also been designated as the single point of contact for the DA major commands and other DOD agencies, the General Services Admin-

istration (GSA), and other military services for arranging preplanned supply support for the OPLANs of the supported command.

b. AMC performs its planning and support operations by assigning appropriate tasks to the various staff elements of the headquarters, and to its major subordinate commands, agencies, separate installations, and activities. The responsibilities, policies, and procedures for development of AMC logistics support plans (LOGPLANS) and capability and readiness estimates are contained in the AMC Logistics Policies and Procedures for Contingency Planning (AMC LP&P).

(1) The Military Plans and Operations Division, Office of Deputy Chief of Staff for Readiness, HQ, AMC, has primary staff responsibility for the development, coordination, and preparation of the AMC LOGPLAN.

(2) Other AMC staff activities, within their areas of interest, provide guidance to subordinate commands regarding the Army Retrieval Microforms System (ARMS), requirements computation, shipment status, order of magnitude cost estimates, requests for additional funds, personnel requirements, priorities, and development of the commander's estimate of capability and readiness.

(3) AMC Deputy Chief of Staffs are responsible for review, analysis, and evaluation of the subordinate commanders' estimate of the capability and readiness to support and execute a specific AMC LOGPLAN and to prepare their appropriate portions of the AMC commanders' capability and readiness position.

c. AMC commodity managers and service item control centers (SICCs) based on guidance in the AMC LP&P as modified by pertinent LOGPLAN.

(1) Provide materiel for which they have management responsibility to support forces identified in each AMC LOGPLAN.

(2) Compute supply requirements except for conventional class V, Class VII (both computed by the AMC logistics programs support activity (LPSA) and class VIII (computed by The Surgeon General (TSG)) items for U.S. forces as required by the Army component commander OPLAN. Computations are based on troop strength, equipment requirements data/equipment density data (ERD/EDD), level of maintenance to be performed in the operations area, supply guidance, and prescribed computation criteria.

(3) Prepare and pre-position supply and transportation documentation for computed supply requirements for each LOGPLAN.

(4) Provide CSDA-automated listing of items, quantities, and capability to support requirements for which requisitions have been prepared.

(5) Maintain requisitions for DLA- and GSA-controlled items and forward requisitions to these agencies upon execution of the supported LOGPLAN.

(6) Prepare and submit nonunit cargo data in JOPSREP format for computed supply requirements, based on schedules developed in coordination with the supported command planner.

(7) Provide logistics assistance and liaison personnel as directed.

(8) Prepare an estimate which evaluates all available resources and capabilities to support the plan and identify any problem areas or limiting factors.

(9) Prepare and coordinate materiel fielding plans identifying field support requirements.

(10) Provide new equipment training (NET) teams to assist in the introduction of new systems to the field.

d. Responsibilities peculiar to various AMC activities in support of each supported command OPLAN are:

(1) DESCOM.

(a) Based on information from the Structure and Composition (SACS) File (obtained from the Deputy Chief of Staff for Operations and Plans (DCSOPS), DA), unit assets reports, and from information provided by FORSCOM for fragmented units, DESCOM develops equipment requirements data/equipment density data for Army units on the TPFDL. This information is furnished to AMC elements and other designated addresses, including the Materiel Management Center (MMC) of the supported command.

(b) Based on troop strengths, weapons, and weapon systems (ERD/EDD, the level of prescribed maintenance and resupply requirements criteria, DESCOM computes conventional class V and class VII preplanned supply requirements.

(2) The Anniston Army Depot prepares and maintains in serviceable condition and in a rigged, ready for airdrop configuration, the emergency supply package contained in the AMC LP&P and as prescribed in the Logistics Annex of the OPLAN.

(3) The Logistics Control Activity (LCA) maintains a logistics intelligence file (LIF) to receive, maintain, and coordinate AMC LOGPLAN documentation as well as monitor all supply and transportation support aspects including the flow of data between AMC and the supported command MMC. The LCA also acts as the Army Airlift Clearance Authority (ACA) for processing and clearing air shipments into the military airlift system (DOD 4500.32R (MILSTAMP)).

(4) The AMC Materiel Readiness Support Activity (Lexington, KY), in coordination with appropriate staff offices of HQ, AMC, provides logistics analysis and services in support of the AMC materiel readiness mission.

(5) The Logistics System Support Activity (CSDA-E).

(a) Based on the OPLAN TPFDL, LSSA configures force list for inclusion in the AMC LOGPLAN.

(b) Prepares force list data in an automated format for distribution to AMC organizations for use in requirements determination process.

(c) Receives, summarizes, consolidates, maintains, and distributes nonunit resupply data received from national inventory control points (NICPs)/SICC and TSG.

(d) Provides the Army component commander, or designated planning agent, listings for review and concurrence, indicating items and quantities for which requisitions have been prepositioned at the NICP/SICC. This listing will also indicate the wholesale system capability to support the required quantity at the time the requirement was computed.

(e) Based on NICP/SICC planning data input for the JCS OPLAN logistics capability estimator model.

(6) The AMC Catalog Data Agency (USACDA) provides a complete AMDF to the supported command MMC.

5-9. Medical Supply Support Planning

a. Medical supply is preplanned to support designated units and time phased troop strengths. The units, strengths, and the delivery schedules to support them are found in Annex M to each AMC LOGPLAN. The medical supply in the delivery schedules consists of medical and optical resupply sets. The medical, dental, optical and veterinary supplies found in these sets are determined based upon components of the medical equipment sets authorized units with a health care mission. Lists of components in resupply sets are found in DA Supply Catalog SC-6545-8-CL Series or in Medical Assemblage Component Computer Listings. Resupply sets are estimates for use in support planning. See paragraph 17-3 for a description of requisitioning and distribution procedures needed to effect preplanned supply support.

b. The policies and procedures for preplanned supply of Class VIII materiel are included in Annex M (TSG Supply Plan) to AMC Logistics Policies and Procedures (LP&P) and in Annex M to each AMC LOGPLAN.

c. The Surgeon General is responsible for preparation and authentication of the medical supply annex to each AMC LOGPLAN. The Surgeon General and AMC provide guidance and assistance to U.S. Army Medical Materiel Agency (USAMMA) for the development of preplanned medical supply requirements. USAMMA prepares and prepositions requisitions, by project code, for materiel to be supplied in the medical annex for each AMC LOGPLAN. USAMMA also prepares and submits Transportation Movement Requirements Data (TMRD) for computed preplanned support.

5-10. Support of Communications Systems and Equipment Assigned to U.S. Army Information Systems Command (USAISC)

a. The Army's nontactical telecommunications network, to include the Army portion of the Defense Communications System (DCS), Air Traffic Control Systems, and base (post, camp, and station) communications systems is a worldwide complex of communications networks and control centers which are integrated into a single, compatible, long-haul, general-purpose system. Within a theater of operations, the Theater Communications System (Army), (TCS(A)) interfaces with the DCS at designated access points and the communications system at corps. The TCS(A) is an integrated command and area nodal communication system emphasizing common user access and switching. The TCS(A) is operated by the Theater Communication Command (Army) (TCC(A)) under the command of U.S. Army Information Systems Command (USAISC) and under operational control of Theater Army Commander in both peace and war. Operational characteristics and requirements of this unique communications-electronics (C-E) integrated system dictate the need to be supported by a dedicated logistics support system.

b. Intermediate maintenance support for TCC(A) Communication-electronics (C-E) unique equipment is provided by Signal Support Companies (C-E Logistics). Depot maintenance support for TCC(A) unique equipment will be provided by CONUS Depot, Contractors, or host nation support as directed.

5-11. DLA Support

a. DLA is directly responsible to the Secretary of Defense for providing supplies and services used in common by the military services. The military services determine their requirements for this materiel and establish their own priorities. DLA

supply centers, based on the services' requirements determinations, compute consolidated requirements, procure the supplies from commercial sources and maintain stocks to meet the military needs.

b. In support of an OPLAN of Army component commands of unified commands, DLA provides materiel under its management responsibility upon request. DLA, also upon the request of a NICP/SICC provides estimates of its capability to provide DLA-managed items to support a specified OPLAN.

5-12. GSA Support

GSA, through its Federal Supply and Service (FSS), provides worldwide supply support to military and civil agencies for those supply classes and items which have been assigned under the National Supply System concept. These items are normally identified as items which are available in the commercial market and are not weapons related or peculiar to a single military agency program.

a. FSS through a requirements forecasting system, maintains inventory levels of these items to support the projected demands. When an OPLAN is executed, the NICP/SICC will forward the requisitions to FSS for action. If the OPLAN requirements for stock item are of an unusual magnitude, the requirements are converted to direct delivery from the supplier when feasible.

b. FSS will use any means of transportation which is available to effect delivery. If premium transportation is required to meet required delivery date, the costs will be included in the billing.

5-13. Transportation Operating Commands Support

The Secretary of Defense has established agencies to furnish specific types of support throughout DOD. Military Traffic Management Command (MTMC), Military Sealift Command (MSC), and MAC have been designated single managers charged with providing transportation support within their charters and normal operational environment. In general, TOAs provide transportation within and outside CONUS, and operate user ocean terminals and worldwide air terminals. The TOAs are involved in the development of plans early in the concept development process by participating in planning conferences and coordination of various planning documents. When the service component commands and supporting commands complete their supporting plans, the TOAs using the TMRD provided by these commands develop preliminary movement tables in JOPSREP format.

These preliminary movement tables, when approved, become part of the TPFDD package. Appropriate TOAs are responsible for the development of detailed movement tables and schedules for the movement of forces and resources. Although not formally a part of JOPS III, the TOA ADP systems support the joint planning function with command-unique systems to provide movement tables for the JOPS community.

a. Military Traffic Management Command. MTMC is chartered in part as the single-manager operating agency for traffic management support for movement of defense freight within and from CONUS; operating common-user ocean terminals, and water terminal clearance authority responsibilities in CONUS and those overseas areas designated by DOD. In support of the OPLANs of the unified/specified commands, MTMC prepares plans and provides, in coordination with MAC and MSC, for the CONUS movement of planned supply increments identified in each OPLAN from supply source to outloading (air/water) terminals for transshipment to overseas destination. It also preselects CONUS outloading ocean terminals and determines CONUS terminal arrival date (CTAD) for each planned supply increment identified in each OPLAN.

b. Military Airlift Command. MAC is composed of controlled transport aircraft together with personnel, facilities, and equipment necessary to support the operation. The MAC airlift responsibilities include strategic airlift for long-range deployment of military forces and management of tactical airlift within a theater of operations. MAC also provides airlift transportation planning support to the organization of the JCS, the unified and specified commands, the military services, and DOD agencies in support of the plans of JCS and develops plans to ensure the efficient use and control of military-owned and commercial air transportation resources and capabilities made available to DOD.

c. Military Sealift Command. MSC is the single manager for ocean transportation conducted between points in CONUS and overseas areas, between and within overseas areas, and in intercostal service with CONUS, and those additional functions specifically assigned by the Secretary of Defense. MSC provides ocean transportation planning support to the organization of JCS, the unified and specified commands, the military services, and DOD agencies in support of the plans of JCS. It also develops plans to ensure the efficient use and control of military-owned and commercial ocean transportation resources and capabilities

made available to DOD under mobilization or other emergency conditions.

5-14. Planning Emergency Support for Allies.

a. Ordinarily, the requirements of forces of allied nations are furnished by the parent nation. A U.S. unified command may, as a result of bilateral agreements, provide support to the forces of allied nations. In the latter instance, the requirements for forces of allied nations would be screened by the U.S. unified command to ensure requirements are within the policies set forth in the agreement and the issue would not impair the effectiveness of U.S. forces. In cases where the forces of the allied nations in question are operating under an allied commander, the requirements would be screened in the light of policies established by the allied commander.

b. Under certain conditions, logistics support is provided to free world military assistance forces (FWMAF) under the Foreign Assistance Act of 1961 (22 USC ct. seq.) and the Foreign Military Sales Act (22 USC 2751 ct. seq.) as amended even though no U.S. forces are employed or U.S. forces in limited numbers only are employed. When specifically directed or authorized by appropriate authority, DA materiel, services, and facilities may be furnished to allied foreign governments or international organizations under emergency or combat conditions. In the absence of instructions to the contrary, the support will be furnished on a reimbursable basis in accordance with agreements consummated at departmental or overseas command level.

c. The unified command OPLAN, as appropriate, will provide for logistics support to FWMAF involved in contingency operations. AMC, on the basis of guidance contained in the OPLAN, will compute supply requirements, maintain supply documentation, and prepare and submit TMRD. Separate supply schedules are developed by the Army component for the support of allied forces and U.S. forces employed in the objective area.

d. The U.S. Army may, as prescribed in AR 700-7, furnish through a single pipeline system, items of materiel to U.S. and allied armed forces in selected foreign countries. Allied forces may participate in a single pipeline system only when arrangements with the foreign country have been formalized in supply support arrangements, memorandum of understanding, or other agreements which set forth the conditions of the arrangements. The basis interface of all allied forces with

the U.S. Army pipeline and such other factors as force/activity designators, requisitioning channels, responsibility and authority of allied forces, ownership/control of stocks and condition under which support is furnished, should be spelled out in the agreement. The execution of supply pipeline agreements with all eligible and qualified allied forces

who participate and provide resources and personnel to operate in-country facilities will be within conditions mutually specified. The single supply pipeline system for any geographical area is incorporated into a jointly staffed or U.S. Army unilaterally staffed supply system established in support of the area.

Section III. PLANNING FOR MOBILIZATION

5-15. Force Mobilization Planning

a. DA provides guidance for full, total, partial, and selected mobilization based on resources expected to be available to counter threats in the short-, medium-, and long-range time periods. Satisfying the force requirements for any contingency to meet these threats is accomplished through mobilization planning. This planning identifies the requirements, assesses the resources available, and makes provisions for satisfying the requirements based on priorities and time-phased requirements for forces, supplies, and equipment for contingency situations. The force requirements of the military situation may require rapid expansion of the active Army involving the mobilization of Army National Guard of the United States (ARNGUS), and U.S. Army Reserve (USAR) units. The situation may require a full, total, partial, or selective mobilization. The mobilization might be accomplished according to established plans or it might be accomplished without adequate control of HQDA, should communications to DA be interrupted. Plans of MACOMS should, therefore, provide appropriate latitude and authority to accomplish the mobilization of Reserve units, as necessary, should communications between HQDA and major commands be interrupted.

b. Mobilization plans are developed by all commands, agencies, activities, and installations as required by the MACOM. Major commands may require subordinates to develop a complete, limited, or abbreviated plan, or in certain cases use the plan of the parent or host activity. The coverage of each type plan is prescribed by the higher headquarters. As a minimum, the plans should provide for alerting and mobilizing the forces; administrative processing; movement of units from unit home stations to mobilization or duty stations, or to port of embarkation; training; logistics support; activation and expansion of facilities; and other actions as required to meet requirements of an expanded Army.

c. The Army Industrial Preparedness Program (AIPP) involves the development and maintenance of an industrial base capable of supporting the military materiel requirements of approved forces.

This program includes the planning, programing, and budgeting for the acquisition, production, and maintenance of selected military materiel critical to the support of approved forces stated in the annual Secretary of Defense Logistics Planning and Programing Guidance (LPPG) as implemented by the DA Planning and Programing Guidance (PPG) for the preparation of part I of the Army Materiel Plan (AMP). Policies, procedures, directives, and responsibilities governing the AIPP are contained in AR 700-90.

5-16. Mobilization Planning

a. Overall General Staff responsibility at the DA level for mobilization planning is with DC-SOPS. The responsibilities include the determination of strategic requirements establishing priorities for distribution of materiel and establishing requirements and priorities for the development and acquisition of materiel.

b. The Deputy Chief of Staff for Logistics (DCSLOG), DA is responsible for strategic mobility planning, logistics readiness of Army forces, managing resources (except major item acquisition) required to achieve logistics objectives and managing all aspects of Army security assistance logistics support.

c. The Deputy Chief of Staff for Research, Development, and Acquisition (DCSRDA) is the single focal point with DA for industrial preparedness planning, policy formulation, guidance, and acquisition of major items of materiel.

d. The Chief, National Guard Bureau and the Chief, Army Reserves are responsible for matters which affect the mobilization readiness of ARNGUS and USAR units.

e. The commanders of FORSCOM, TRADOC, MTMC, and AMC are responsible for training, guidance, and mobilization readiness for units and installations under their command and logistics support of units mobilized.

f. The Commander, AMC, is responsible for materiel (except medical). AMC operates the AIPP. This includes the review of DA-generated requirements, Industrial Preparedness Plans, procurement actions, Production Base Support Program,

inventory management for secondary items and repair parts, and the depot level maintenance mobilization program. AMC materiel readiness/commodity identify and select planned items, compute maintenance mobilization requirements, and conduct planning with industry for mobilization production.

g. State adjutants general are responsible for keeping area CONUS Army commanders and other area commands informed of all matters which significantly affect the mobilization of ARNGUS units under their control. They are also responsible for providing area commanders with mobilization plans for units under their control and providing appropriate mobilization station commanders up-to-date equipment status and serviceability information.

h. Army Reserve Commands (ARCOMs) and General Officer Commands are responsible in peacetime for the adequacy and readiness of units under their control.

5-17. Logistics Concepts for Mobilization Planning

a. The dependence on Reserve forces, to enable the United States to execute the OPLANs of unified commanders or for the defense of CONUS,

dictates the need for comprehensive planning for the changeover from logistics support through ARNGUS and USAR supply systems to the supply system of the Active Army for those Reserve component units ordered to active duty during a mobilization. Upon entry on active duty, the commanding officer of the unit must provide for subsisting and quartering his troops at home station as outlined in the Army Mobilization and Operations Planning System (AMOPS) and FORSCOM's Mobilization and Deployment Planning System (FORMDEPS).

b. Equipment for support of Reserve component units should either be on hand in the unit, on requisition, or positioned in specifically earmarked stocks at an Army depot. Quantities of equipment authorized are those quantities considered essential for mobilization training or emergency contingency deployment. Distribution of available equipment is determined by priorities in AR 11-12 and current and projected distribution is reflected in the Total Army Equipment Distribution Program (TAEDP).

c. After the unit is located at its mobilization station, its logistics support is received from the Active Army logistics system in accordance with established procedures.

Section IV. SUPPORT OF CIVIL DEFENSE, DISASTER RELIEF, AND CIVIL DISTURBANCE CONTROL OPERATIONS

5-18. Civil Defense

a. By law (50 USC App. 2251 et. seq.) civil defense is a joint responsibility of Federal, State, and local governments. The national civil defense program is an integral part of the national security and is an essential element of the Nation's deterrent posture. DOD recognizes the essential interdependence of the civil and military defense efforts of our Nation in achieving the total posture of national security. Military support to civil authorities in civil defense operations is an emergency task within the mission of all defense agencies and Federal active duty and Reserve component units of the military services. The basic objectives of the program are to—

- (1) Protect life.
- (2) Save lives and protect property.
- (3) Sustain survivors and repair essential utilities.
- (4) Achieve emergency operational capability.
- (5) Provide support.

b. In the event of enemy attack on the United States, Army forces must be prepared to employ

all resources not engaged in or directly supporting essential operations to assist civil authorities in—

- (1) Restoring order and civil control.
- (2) Returning essential facilities to operation.
- (3) Preventing unnecessary loss of life and damage to property.
- (4) Alleviating human suffering.
- (5) Taking other emergency actions as directed to insure national survival and a capability on the part of the Nation to achieve national objectives.

c. The Commander, FORSCOM is responsible within the 48 contiguous States for establishing State military headquarters to plan for and conduct operations in support of civil defense. The Commander FORSCOM is responsible for the readiness of all Army forces in CONUS to conduct emergency civil defense operations and the training of Army personnel in the basic functions of civil defense. The direction and control of resources used for civil defense, including those resources made available by other military departments and defense agencies is exercised by the Commander, FORSCOM. The Commander FOR-

SCOM also coordinates military defense plans with civil defense plans. One of the important services that is made available to civil defense operations is Explosive Ordnance Disposal (EOD).

d. Commanders of other U.S. Army major commands and heads of DA General and Special Staff agencies support the requests of the Commander, FORSCOM and CONUS Army commanders in execution of their civil defense responsibilities. The Commander, U.S. Army Information Systems Command is charged with operating and maintaining designated communications systems including warning and emergency systems. Overall monitoring of military support of civil defense matters within the DA Staff is exercised by DCSOPS. Installation commanders furnish immediate supplementary support to local civil authorities where civilian control is no longer effective.

e. Army contingency plans for operation in a civil defense role should provide for priorities of support planning and training assistance, maximum decentralization, and use of military resources when needed to complement use of civil resources.

f. In planning for civil defense it is assumed that, in the event of a declared emergency situation, the President will invoke provisions of Federal Civil Defense Act of 1950 (50 USC App. 2291-2297), as amended, and the Secretary of Defense will be authorized to incur obligations and expropriate defense resources including materiel, equipment, utilities, etc., for civil defense purposes, without regard to existing laws. All Army preparedness measures for emergency civil defense operations are undertaken within programs established for accomplishment of the Army's combat mission.

5-19. Support of Disaster Relief

a. As in civil defense, disaster relief is primarily the responsibility of civil governments. Military assistance to civil authorities in natural disasters may be provided by DOD when requested or directed in accordance with the Disaster Relief Act of 1974 (42 USC 5121-5202). U.S. Army participation is in accordance with AR 500-60.

b. Normally, military support to disaster relief will be at the request of the Director, Federal Emergency Management Agency (FEMA), who is responsible for coordinating the activities of all Federal agencies in rendering support to State and local governments during major natural disasters. However, when the disaster is of such imminent seriousness that delay in awaiting instructions is unwarranted, a military commander should take such action as may be required and justified to

save human life, prevent immediate human suffering, or mitigate major property damage or destruction. The Secretary of the Army is DOD Executive Agent for disaster relief activities within the United States. This includes responsibility for effective use, coordination, and control of resources made available by other components of DOD. The Commander, FORSCOM, is responsible for Army support activities within CONUS to include coordination with other services or defense agencies or both. Commanders of all U.S. Army major commands support disaster relief operations with military resources as required by the Commander, FORSCOM. Installations, activities, and agencies support disaster relief efforts within their capabilities. The Chief of Engineers provides disaster assistance to FEMA as a function under its Civil Works Program.

c. Disaster relief support in friendly foreign areas is conducted by the commander, unified command in response to requests from the State Department. In Alaska, Hawaii, and U.S. territories, the appropriate unified commander is responsible for the conduct of disaster relief operations until such time as directives or agreements promulgated by the U.S. Government prescribe otherwise.

d. Planning for military support of disaster relief should consider all aspects of logistics. The types of support required will vary according to type and intensity of damage, local facilities, density of population, and warning received. Logistics support most likely to be requested includes:

- (1) Evacuation, housing, and feeding.
- (2) Care of injured.
- (3) Supply of clothing, food, and medical supplies.
- (4) Water purification.
- (5) Emergency communications support.
- (6) Physical security.
- (7) Fuel for cooking, heating, and transport.

5-20. Support of Civil Disturbances Control Operations

a. *State and Local Government Roles.* The protection of life and property and the maintenance of public order are primarily the responsibility of State and local governments. Local and State police are normally capable of fulfilling this responsibility. When the level of violence exceeds their capabilities, the governor of a State can commit the State National Guard. Generally, Federal Armed Forces are employed after State and local civil authorities have used all of their own forces which are reasonably available for use, and are unable to control the situation, or when the

situation is beyond the capabilities of State or local civil authorities, or when the State and local civil authorities will not take appropriate action.

b. DA Role.

(1) The Secretary of the Army is the designated executive agent for DOD in all matters pertaining to the planning for, and the deployment and employment of military resources in the event of civil disturbances. This includes calling to active Federal service units of the Army National Guard to carry out the provisions of the Presidential Executive Order or other appropriate authorities.

(2) The DOD Executive Agent has been delegated the authority to exercise, through the Chief of Staff, U.S. Army, the direction of those forces assigned or committed by the military departments.

(3) At the DA level, the Director of Military Support, Office of the Deputy Chief of Staff for Operations and Plans has General Staff responsibility for civil disturbances outside the installation. For disorders occurring totally within an institution, the responsibility is that of the Deputy Chief of Staff for Personnel (DCSPER).

(4) DOD has designated the Secretary of the Army as executive agent for providing assistance to the Federal Bureau of Investigation (FBI) in combatting terrorism in the 50 United States, District of Columbia, Commonwealth of Puerto Rico, and U.S. possessions and territories. In such instances, military resources may be used, as in civil disturbances provided for in AR 500-50 to protect life or Federal property or prevent disruption of Federal functions upon request of the Director, FBI or senior FBI official present at the scene of a terrorist incident.

c. Role of Other Military Services. The other military services are responsible for providing military resources as required by the DOD executive agency and consistent with defense priorities.

d. Employment of Federal Armed Forces. In addition to the provisions of the Constitution and other basic legal principles, there are numerous statutes authorizing the employment of Federal Armed Forces in cases of violence, or other specific purposes, within any State and within the territories of the United States. The possibility of employment under many of these provisions is considered remote, and only those instances where employment is most likely have been treated in this section. Additional constitutional and statutory provisions for the employment of Federal Armed Forces to include the prerequisites for employment are discussed in AR 500-50 and FM 19-15.

5-21. References

a. Army Regulations (ARs).

1-1	The Army Planning, Programming, and Budgeting System
5-9	Interservice Support: Installation Area Coordination
(C) 11-11	Major Command Stockage Levels Worldwide (U)
11-12	Logistics Priorities
11-27	Army Energy Program
30-7	Operational Rations
40-61	Medical Logistics Policies and Procedures
55-4	CONUS Military Installation Materiel Outloading and Receiving Capability Report (Reports Control Symbol MTMTS-7(R1))
55-30	Space Requirements and Performance Reports for Transportation Movements
55-113	Movement of Units Within Continental United States
55-162	Permits for Oversize, Overweight, Other Special Military Movement on Public Highways in the United States
55-355	Military Traffic Management Regulation
59-105	Aerial Ports
59-106	Operation of Air Force Air Terminals
75-15	Responsibilities and Procedures for Explosives Ordnance Disposal
220-10	Preparation for Oversea Movement Units (POM)
310-25	Dictionary of United States Army Terms
310-34	Equipment Authorization and Utilization Policies and Criteria and Common Table of Allowances
310-49	The Army Authorization Documents System (TAADS)
310-50	Catalog of Abbreviations and Brevity Codes
415-16	Army Facilities Components System (Military Engineering Construction Support Designs, Materiel, and Planning Data)
415-35	Minor Construction
500-50	Civil Disturbances
500-60	Disaster Relief
500-70	Military Support of Civil Defense

525-1	The Department of the Army Command and Control Systems (DACCS)		<i>c. Technical Manuals (TMS).</i>
525-10	The Department of the Army Command and Control Reporting System (DAXREP)	38-250	Preparation of Hazardous Materials for Military Transport
700-2	Defense Logistics Agency (DLA)	38-450	Storage and Maintenance of POMCUS
700-4	Logistics Assistance Program		<i>d. Department of Defense Publications.</i>
700-7	Wartime Standard Support System for Foreign Armed Forces	DODD	Criteria for Selection of Items for War Reserves
700-9	Policies of the Army Logistics System	3005.5	
700-22	Worldwide Ammunition Reporting System (WARS) (Reports Control Symbol CSGLD-1322 (RI))	DODI	Employment of Military Resources in Natural Disaster Emergencies Within the United States, Its Territories and Possessions
700-23	Supply of Hygienic and Comfort Items	3025.1	
700-90	Army Industrial Preparedness Program	DODI	Military Support of Civil Defense
708-1	Cataloging and Supply Management Data	3025.10	
710-1	Centralized Inventory Management of the Army Supply System	DODI	Employment of Military Resources in the Event of Civil Disturbances
710-2	Inventory Management and Supply Policy Below the Wholesale Level	3025.12	
710-3	Asset and Transaction Reporting System	DODI	Requisite Characteristics for War-time Readiness of DOD Supply Systems
725-50	Requisitioning, Receipt, and Issue System	31103	
735-5	Basic Policies and Procedures for Property Accounting	DODI	Basic Policies and Principles for Interservice, Interdepartmental, and Interagency Support
735-11	Accounting for Lost, Damaged, and Destroyed Property	4000.19	
740-1	Storage and Supply Activity Operations	DODD	Functions of the DOD and Its Major Components
750-1	Army Materiel Maintenance Concepts and Policies	4100.1	
750-7	Installation Support Maintenance Activities	DODD	Management of War Reserves
	<i>b. Field Manuals (FMS).</i>	4140.2	
101-5	Staff Officers' Field Manual: Staff Organization and Operations	DOD	Manual Procedures for the Management of Petroleum Products
101-10-1	Staff Officers' Field Manual: Organizational, Technical, and Logistical Data Unclass	4140.25	
101-10-2	Staff Officers' Field Manual: Organizational, Technical, and Logistical Data Extracts of Nondivisional Tables of Organization and Equipment	DODI	Secondary Item War Reserve Requirement Development
701-58	Planning Logistics Support for Military Operations	4140.47	
704-28	Classes of Supply	DODI	Sale of Surplus Military Equipment to State and Local Law Enforcement and Firefighting Agencies
		4160.23	
		DODI	DOD Priorities and Allocations Manual
		4400.1	
			<i>e. Joint Chiefs of Staff Publications (JCS Pub).</i>
		1	DOD Dictionary of Military and Associated Terms
		2	Unified Action Armed Forces (UNAAF)
		3(C)	Joint Logistics and Personnel Policy and Guidance (JLPPG) (u)
		4	Organization and Functions of the Joint Chiefs of Staff
		6	Joint Reporting Structure (JRS)
		7	Worldwide Military Command and Control System Standards (WWMCCSS)
		15	Mobility System Policies, Procedures, and Considerations
			<i>f. FORSCOM Regulations.</i>
			FORSCOM Financial Management Plan for Emergency Conditions
		Reg 37-11	

FORSCOM Reg 55-1	Unit Movement Plans and Reports		cedures for Contingency Planning (AMC LP&P)
FORSCOM ARRED/ ARLANT Reg 525-1	Operation Planning	SB 10-495	Standard "B" Ration for the Armed Forces
FORSCOM/ ARRED 525-15	Narrative Operational Reporting System (U)	SB 10-495-1	Standard "B" Hospital Rations for the Armed Forces
FORSCOM Reg 700-2	FORSCOM Standing Logistics Instructions	SB 10-495-2	Standard "B" Ration to be Stored for Operational Projects and In-place Reserves
FORSCOM Reg 700-3	Basic Ammunition Load Supply Data	SB 10-496	Supply Control; Wartime Replacement Factors and Consumption Rates for DSA/GSA Assigned Items
<i>Note:</i> FORSCOM publications may be obtained from:		(C) SB 38-26	Nonnuclear Ammunition Supply Rates (U)
Commander		SB 700-20	Army Adopted/Other Selected Items and List of Reportable Items
Fort Gillen		SB 700-40	War Reserve Stockage List (WARSL)
ATTN: Publications Stock Room		SB 710-2	Supply Control: Combat Consumption Data for Ground and Aviation Type Petroleum Products
Forest Part, GA 30050		CTA 8-100	Allowances of Army Medical Service Expandable Supplies
<i>g. Miscellaneous Publications.</i>		CTA 50-900	Clothing and Equipment
AMOPS	Army Mobilization and Operations Planning System	DA Pam 27-21	Military Administrative Law Handbook
VOL I	Systems Description, Responsibilities and Procedures		
VOL II	Strategic Employment and Army Forces		
VOL III	Army Mobilization and Deployment Planning Guidance		
VOL IV	Army Crisis Action System (C) AMC Logistics Policies and Pro-		

PART THREE: ACQUISITION FUNCTION

CHAPTER 6

MATERIEL ACQUISITION

Section I. DETERMINING MATERIEL REQUIREMENTS

6-1. Army Acquisition Policy (AR 70-1)

a. Army materiel needs generally are satisfied through one of three alternative methods:

(1) *Product Improvement Programs.* Product improvement exploits performance growth potential inherent in fielded systems. This is usually the preferred method of satisfying requirements.

(2) *Non-developmental.* Purchase of existing military or commercial, domestic or foreign items. This method can provide a low-cost, quick response to some requirements.

(3) *Developmental.* Only if these alternatives will not satisfactorily overcome the deficiencies should a new development program be initiated. In addition, new developments should employ the integration of proven components including commercial components rather than revolutionary, technological approaches whenever possible. New development programs must consider the advantages of Pre-Planned Product Improvement (P31) when developing acquisition strategy (AS).

b. The acquisition strategy is the conceptual framework for conducting materiel acquisition; this encompasses the broad concepts and objectives which direct and control the overall development, production and deployment of a materiel system. The acquisition strategy formally documents how the acquisition program will be tailored, identifies potential risks, and provides a basis for the development of functional plans contained in the various program documents.

c. Low-risk developmental programs which feature integration of mature technologies or proven components including commercial components should be considered as candidates for the Army Streamlined Acquisition Process (ASAP). Streamlined aspects should be clearly identified and approved via the AS.

6-2. Concept Based Requirements System (CBRS) (AR 71-9)

a. The CBRS is a process by which doctrine, organizational, and materiel needs are identified through the development and analysis of operational concepts. The CBRS is initiated by inputs from Army missions, historical perspective, threat, and technological forecasts. It considers three fac-

tors: first, an analysis of potential enemy threats; second, a breakthrough in technology which might signify a need for new or improved systems; and third, known deficiencies which might exist in fielded systems.

b. The need for an acquisition program is identified through continuous, on-going efforts called Mission Area Analyses (MAAs). The MAA process constantly assesses the capability of a force to perform within a particular battlefield or functional area. The MAA is designed to discover deficiencies in doctrine, organizations, training and materiel and to identify means of correcting those deficiencies.

6-3. The Department of the Army Long-Range Research, Development and Acquisition (LRRDA) Plan.

This plan displays R&D programs in support of requirements identified by Mission Area Analysis and summarized in the Battlefield Development Plan. It prioritizes programs and supports the fielding of required equipment; supports the fielding of required equipment to units in accordance with the approved force structure guidance of the Army; projects program profiles in the Extended Program Annex (EPA) years. The plan covers 17 years and provides guidance from Army leadership prior to program formulation. It is used as the starting point for program building and program initiation.

6-4. Operational and Organization Plan (O&O Plan).

Describes how a system will be integrated into the force structure, deployed, operated and supported in peacetime and wartime. The concept establishes required readiness objectives and is the basis for Integrated Logistics Support Planning. The O&O Plan describes the need for an operational capability to defeat the threat or eliminate an operational deficiency.

The O&O Plan should have as much detail as possible within the 10-page limit. Programs which use a mission need statement (MNS), JSOR, or ROC will normally be initiated by an O&O Plan. TRADOC approval constitutes program initiation for nonmajor programs.

6-5. Mission Need Statement (MNS)

The MNS is a requirements document prepared by the U.S. Army Training and Doctrine Command (TRADOC), in coordination with AMC, to identify and support the need for a major system new start of an improved mission capability. It is limited in use to those new projects which are large enough to require decisions by the Office of the Secretary of Defense (OSD). A MNS will be required on all major programs.

6-6. Paragraph 6-6 is rescinded.**6-7. Required Operational Capability (ROC).**

A ROC is a Headquarters, Department of the Army (HQDA) document which states the minimum essential operational, technical, manpower and personnel integration (MANPRINT), logistic, and cost information necessary to initiate the development-production prove out phase or procurement of materiel system. The function of the

ROC is to serve as the definitive statement of user need.

6-8. Paragraph 6-8 is rescinded.**6-9. Program Management Document (PMD) (AR 70-1)**

a. PMD is the term used to describe the collection of documents depicting how a materiel requirement will be satisfied through the acquisition process. These documents are divided into three categories:

- (1) Requirements documents.
- (2) Decision documents.
- (3) Program documents.

b. The individual documents in the PMD will be refined and updated throughout the phases of the materiel acquisition process. The PMD may be simplified, or portions omitted, if appropriate, depending on the complexity and stage of the specific program.

Section II. RESEARCH, DEVELOPMENT, TEST, AND EVALUATION (RDTE)**6-10. Objectives**

a. The objective of Army research and development (R&D) is timely development of weapons, equipment, and systems all at minimum total cost and with adequate performance to meet approved operational requirements and capable of being effectively manned and supported in any environment, and under all conditions of war. To accomplish this objective, the Army must:

(1) Maintain a strong technological base to provide fundamental information in support of materiel system development. This includes basic and applied research, exploratory development, and nonsystem advanced development.

(2) Become and remain aware of R&D being pursued by industry, other services, allies, and other nations, including potential enemies.

(3) Develop materiel systems which meet Department of the Army (DA) materiel requirements, are logistically supportable, can be acquired within budget constraints, and are operationally effective and cost-effective.

(4) Lengthy RDTE development period toward acquisition of nondevelopmental item (NDI) will be reduced. Provision of general performance requirements will be furnished to the bidders rather than detailed specifications or drawings. Contractors will be required to bid on an existing system meeting the general performance requirement for review by the Army. An existing system will include all associated equipment to support the

system, i.e., vehicle, generator, communication-electronic, transmission, communication-security, system controls, etc. Government-furnished equipment will not be provided.

b. Reference is AR 70-1.

6-11. RDTE Categories

a. Basic Research (6.1) is the first category (see figure 6-1) and includes scientific study and experimentation directed toward increasing knowledge and understanding in those scientific fields which are related to national security needs.

b. Exploratory Development (6.2) includes efforts directed toward solving scientific military problems. It is pointed toward developing and evaluating the feasibility and practicability of proposed solutions and determining their parameters.

c. Advanced Development (6.3) includes all projects for developing prototypes or techniques for experimental or operational test. Advanced Development in the Army is divided. Nonsystem Advanced Development (6.3A) is for fabrication of components and subsystems which have a potential application to a variety of end items rather than one specific, well-defined system. System Advanced Development (6.3B) is for fabrication of components and subsystems which pertain to a specific end item.

d. Engineering Development (6.4) is for the entire system (end item, operators and maintainers,

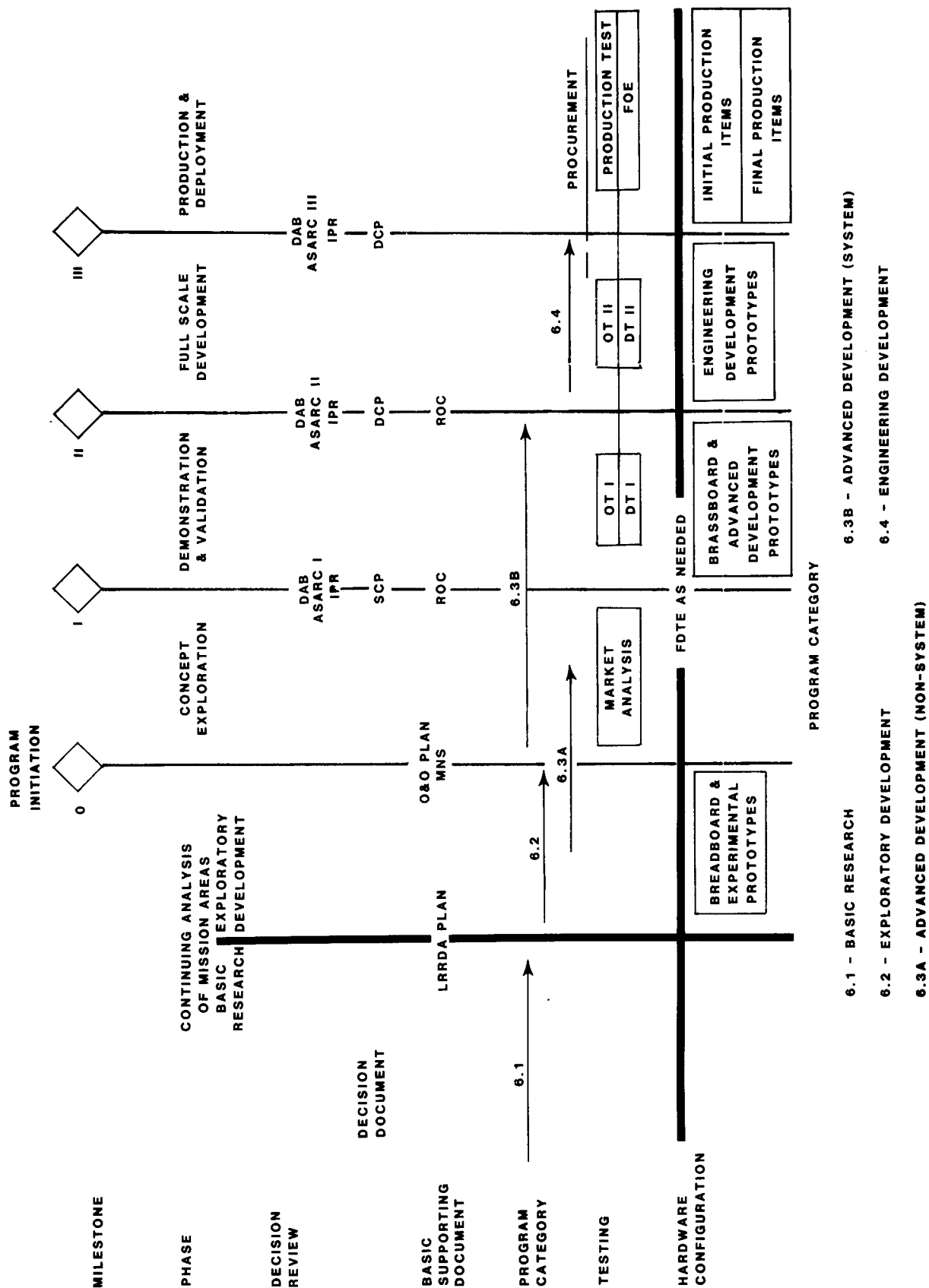

Figure 6-1. RDTE in the Life Cycle

training support, and logistics support). These have not yet been approved for acquisition or operations.

e. Management and Support (6.5) is for general support of R&D installations or operations.

f. An RDTE category now shown on the model is Operational Systems Development (6.7). This is for R&D effort after a system has been approved for production and employment.

Section III. MANAGEMENT CONTROLS AND TECHNIQUES

6-12. The Life Cycle System Management Model (LCSMM) (DA Pam 11-25)

One of the responsibilities of materiel developers is to ensure the equipment required to deter threats of aggression is available on a timely and cost-effective basis. The LCSMM is a flow chart which depicts the process by which Army materiel systems are initiated, developed, and supported. The model is a graphic picture of research and development, testing, documenting, decisionmaking, production, fielding, operational usage, and disposal of a materiel system. The model is divided into four phases.

6-13. The Materiel Acquisition Decision Process (MADP) (DODD 5000.1, DODI 5000.2, and AR 15-14).

a. MADP is the review of a program or project at critical points to evaluate status and make recommendations to the decision authority. Major management decisions during the life cycle are made at Milestones (I thru V) appropriate to the particular program. No single procedure can apply to the acquisition of all materiel systems. Generally, one of three levels of review will be used for key decisions on DOD major programs, designated acquisition programs (DAP) and inprocess review (IPR) programs.

b. The MADP reviews are performed by—

(1) *The Defense Acquisition Board (DAB)*. The DAB provides information and recommendations to the SECDEF when decisions are necessary on DOD major programs.

(2) *The Army Systems Acquisition Review Council (ASARC)*. The ASARC develops the Army's course of action on DOD major programs in preparation for DAB review and provides information and recommendations for decisions by the AAE and Defense Acquisition Executives (DAE).

(3) *The IPR*. The IPR makes recommendations to the appropriate decision authority when milestone decisions are required for systems that are neither DOD major programs or DAP.

6-14. Integrated Logistics Support (ILS)

DODD 5000.39 defines ILS as a disciplined, unified and iterative approach to the management and technical activities to the following: integrate support consideration into the system and equipment design; develop support requirements that are consistently related to the design and to each other; acquire the required support; and provide the required support during the operational phase at minimum cost. AR 700-127 describes in detail the elements of ILS. Summarized, the elements are—

a. Design influence to include logistic-related reliability, availability, and maintainability.

b. The maintenance plan.

c. Manpower and personnel.

d. Supply support.

e. Support equipment and test, measurement, and diagnostic equipment.

f. Training and training devices.

g. Technical data.

h. Computer resources support.

i. Packaging, handling, and storage.

j. Transportation and transportability.

k. Facilities.

l. Standardization and interoperability (S&I).

6-15. Project Management

Project management is an organizational technique used to provide intensive management by a single responsible individual. The project manager has the authority to cross functional staff and command lines of authority in order to develop, modify, or procure materiel systems within cost, schedule, and performance thresholds. In the Army, the project manager is given the authority by the Secretary of the Army in a charter which assigns the mission, coordinating agencies, and limits of authority. Details regarding project management in the Army are contained in AR 70-17.

6-16. Test and Evaluation (T&E)

a. T&E are integral parts of a system's life cycle and their primary purposes are to identify design

deficiencies and provide timely and reliable data and information; evaluate technical performance, system operational effectiveness and suitability, through the assessment of the issues identified in the TEMP; determine the system's ability to operate in its intended threat environment.

b. There are two broad categories of testing—technical and user testing.

(1) *Technical test (TT)*. The TT is a generic term that encompasses technical feasibility tests, development tests, qualification tests, joint development tests, and contractor of foreign tests. (See AR 70-10.)

(2) *User test (UT)*. The UT is a generic term that includes force development test and experimentation (FDTE), innovative test, concept evaluation (IOTE), follow-on operational test and evaluation (FOT&E), onsite user test (OSUT), and joint operational test.

(3) The following considerations are addressed during the test and evaluation of systems throughout the life cycle:

(a) Reliability, availability, and maintainability (RAM).

(b) Safety and health.

(c) Manprint.

(d) Logistic supportability.

(e) Test support packages.

(f) Climate.

(g) Transportability.

(h) Electromagnetic compatibility (EMC).

(i) Electromagnetic vulnerability (EMV).

(j) Vulnerability and survivability, including vulnerability from noncombat threats, environmental impacts, battlefield automated systems (BAS), airworthiness, nuclear, RSI, and chemical.

6-17. Materiel Release for Issue

Prior to release for issue, formal and disciplined review, evaluation, and certification will be accomplished to assure Army materiel is suitable and supportable. Released materiel must be suitable in terms of safety, quality, performance, reliability, and maintainability, and must meet the environmental requirements of AR 200-1. It must also be supportable with respect to the requirements of each ILS element. Army Materiel Command Regulation 700-34 prescribes the objectives, responsibilities, and policies for establishing the materiel release program.

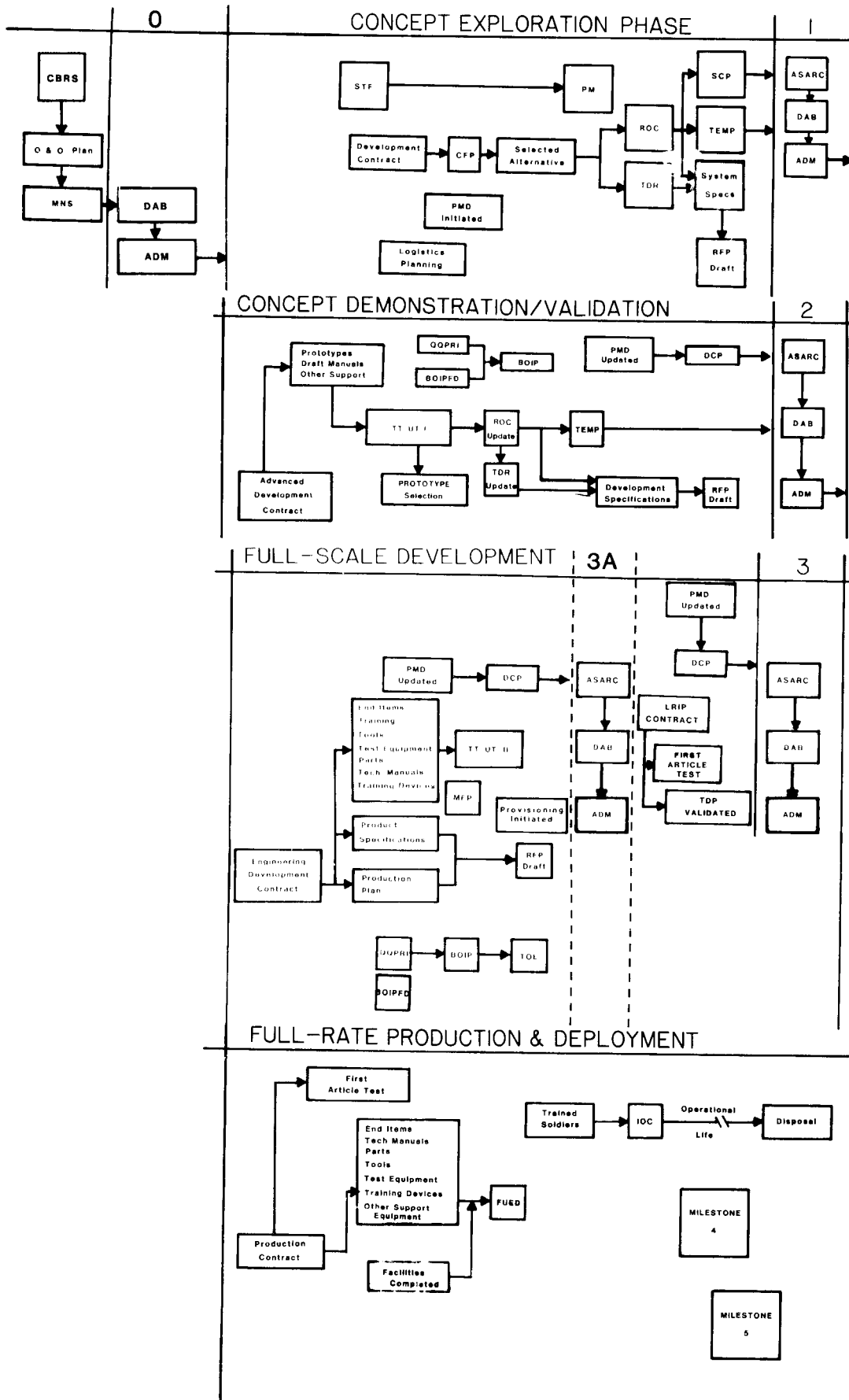

Figure 6-2. Life-Cycle System Management Model

CHAPTER 7 CONTRACTING

Section I. GENERAL

7-1. Introduction

a. Contracting is one of the several functions involved in the Army's acquisition process. It is, in reality, a purely service function to obtain the Army's equipment, supplies, or services of the proper quality and sufficient quantity at a fair and reasonable price.

b. While contracting is not an end in itself, the defense dollar is a significant force in the national economy. The Army acquisition manager faces the challenge of coping with this sheer mass of contracting activities, the increasing complexity of the acquisition process, and the goldfish-bowl environment of the public servant. The manager's acquisitions are scrutinized by contractors, auditors, the General Accounting Office (GAO), Congress, and the news media, and must be accomplished in a manner which is beyond reproach. Therefore, the policy and legal guidance which governs are both detailed and voluminous and can be quite rigid to protect the integrity of the process.

c. Every Army acquisition must be accomplished in accordance with the Federal Acquisition Regulation (FAR), the DOD FAR supplement and the Army FAR supplement.

d. This chapter provides the Army manager with an overview of the acquisition process and the underlying principles, tools, and techniques. This FM does not, however, provide authority to enter into contracts or contain guidance related thereto. Guidelines governing the contracting for goods and services are set forth in applicable acquisition regulations.

7-2. The Acquisition Process

a. Each contracting action in the Army has as its origin a need or requirement for some particular service or product. The requirement's identification and funding sets into motion a sequential, progressive cycle which begins with acquisition planning and ends with contract administration and the delivery of the product or service. The key steps in the acquisition process, are summarized in this chapter.

b. While the acquisition process includes all of the actions which must be taken in obtaining the required goods or services, it must be emphasized there is no single set of actions for each step in the process. Variables, such as type of goods and services required; the size, type, complexity, and urgency of the requirement; and the laws and regulations applicable, all impact upon the actions taken.

c. It should be noted the term "acquisition" covers the entire cycle from need identification and funding through contract administration. The term "contracting" covers the portion of the acquisition cycle starting with the purchase request (as a culmination of the planning step) through contract administration.

7-3. Scope and Magnitude of Army Acquisition

a. Most Army acquisitions fall into one of the eight broad classes discussed below:

(1) *Base support.* The maintenance and operation of installations and bases requires a multiplicity of materials and services of a housekeeping nature. Most of these requirements are acquired by the bases. Some items in common use throughout the Defense Department are centrally controlled and managed by agencies such as the Defense Logistics Agency (DLA) or the General Services Administration (GSA).

(2) *Area support.* Contracting operations in support of installations in a geographic region or area have come into existence to provide, on an economic basis, consolidation of buying and related professional services which can meet the needs of many customer activities in the area served.

(3) *Industrial support.* The arsenals, munitions plants, and overhaul facilities of the Army are major industrial enterprises similar in many respects to their counterparts in private industry. The support of these installations demands a high degree of coordination between production and acquisition staffs to ensure proper materials and equipment are available to meet manufacturing and production schedules.

(4) *Supply system support.* Within the Army and Defense Department supply systems, there are a number of inventory control points (ICPs) which are responsible for the integrated management of specific items or classes of items on a worldwide basis. The contracting operations necessary to support centralized inventory management have characteristics unique to this method of control. The number of items so controlled presents acquisition management problems in the handling of a massive volume of requirements which are often repetitive and of varying technical complexity.

(5) *Weapon systems acquisition.* The process of acquiring more weapons systems is the longest, most complex, and has the greatest dollar volume of any process in the Army. The cycle from concept to de-

ployment of a new system may require up to 12 years, with technical improvements evolving the whole time. The contracts necessary may total billions of dollars and represent the most complicated and sophisticated agreements written by Army contracting activities.

(6) *Research and development.* Each year the Army spends many millions of dollars in basic research and as part of the weapon systems development process. Although some of this effort is accomplished in Government facilities, a large segment of the defense research programs is conducted in private laboratories, in nonprofit and educational institutions, and at defense-related industries.

(7) *Transportation services.* The Army's volume of personnel and materiel movement is considerably in excess of what can be provided by DOD. The acquisition of considerable air and sealift as well as land transportation is, therefore, required. This is a specialized field of contracting where particular laws and regulations and industry practices substantially affect the techniques and manner of doing business.

(8) *Construction.* While much of the maintenance and repair of existing facilities is performed in-house by the Army, the design, engineering, and construction of new facilities is, in large part, acquired from private industry. The field of civil engineering contracting requires extensive education and experience in architectural, engineering, and construction disciplines, and it is subject to specific laws, techniques, and trade practices. It is noted that the U.S. Army Corps of Engineers is the principal construction agent for the Federal Government in the area of civil works, river and harbor improvement, flood control, hydroelectric power, and related projects. The corps has responsibility for construction of military facilities for the Army and, in many areas, performs the same service for the Navy and Air Force.

b. There are long-term consequences from Army and DOD acquisitions which have a profound effect on both the economic development of the country and the national security. Acquisition programs promote decisions on the use and expansion of existing plant capacity, the building of new facilities, the modernization of machinery, the development of manpower and raw material reserves, and a multitude of other aspects of the national economy. Where an acquisition is well managed, costs are decreased and Government and industry relationships are improved while, at the same time, the capability to maximize production during mobilization periods can be enhanced.

c. Government contracts provide significant leverage for the implementation of national social and economic policies which have been established by congressional legislation and Executive orders. These policies provide contractual standards relating to such

economic and social areas as: preference accorded small and disadvantaged business, economically distressed areas, and domestic suppliers; requirement for safe and sanitary working conditions and for the payment of minimum wages; and provisions for equal employment opportunity, employment of veterans, and the employment of blind and other handicapped individuals.

7-4. Laws and Regulations

a. The exercise of powers by Congress and the executive branch in the defense sphere, and the review of the actions of both by the judiciary, has resulted in a large body of laws commonly known as "Government Contract Law." These laws govern the scope and authority of the executive branch, and more specifically the Army, in defense actions. Much of this body of law prescribes the functions and authority of the departments, agencies, and courts, establishes procedures for the conduct and regulation of acquisition activities, and dictates in broad terms the form and content of contractual instruments.

b. Ultimately, however, the United States (and hence the Army) gets its right to contract from the Constitution. All the laws and regulations which govern military acquisitions are derived from the Constitution, which cites in article I, section 8, "Congress shall have the power to raise and support armies."

c. In order to implement the basic provisions of the Constitution, it has been necessary for the Government to formulate laws which are regulatory in nature. In recent years, these laws have been systematically codified into 50 different titles. Of these laws, Title 10 is the one in particular which governs the several military departments, including the military acquisition functions. In this respect, Title 10 is the basic regulatory authority employed by DOD and the Army for the acquisition of supplies and services.

d. Along with Title 10, there are many other congressional enactments, Executive orders, directives, and regulations which impact upon the field of Government contracting. As such, this large body of requirements establishes the basis for the policies and procedures which definitively set forth in the FAR.

e. The FAR is the federal contracting bible. It sets forth the underlying principles, policies, and procedures on a vast array of subjects. Despite its comprehensiveness, however, the FAR recognizes that situations will arise which normal policy and procedures cannot accommodate. It allows for waiver authority in those instances.

f. The individual service acquisition systems differ markedly. They are generally the result of a long pe-

riod of development reflecting both the organizational structure and specific needs of the department.

7-5. Authority and Responsibility

a. The President, in his dual capacity as Chief Executive and Commander in Chief of the Armed Forces, has the authority for ultimate direction of the Military Establishment and its logistical functions. He may derive power and authority to contract from either position or from acts of Congress.

b. Congress, however, exercises control over military acquisitions by providing the funds through authorization and appropriation statutes and the passing of legislation governing the expenditure of these funds. Thus, while executive departments, including the Army, are not dependent upon the Congress for authority to contract, they are clearly bound by congressional restrictions on the exercise of this authority.

c. The head of the contracting activity (HCA) is responsible for the actual management and conduct of acquisitions to carry out the assigned mission. The authority to contract flows through the Offices of the Secretaries of Defense and Army to the major Army commands. These commands are directly responsible for the execution of the Army's annual acquisitions programs. Each buying activity head, by virtue of the designation as HCA, has the authority to acquire all supplies, equipment, or services assigned to, or under the cognizance of, that activity. The HCA also has broad authority to make any contracting determi-

nation and decisions required by law or regulation not specifically reserved to the Secretary. Most important, the HCA has the authority to appoint contracting officers.

d. Every organization, whether corporate, municipal, State, or Federal, has to have agents who act as its representatives in making contracts. The general and statutory powers of the Government to contract are exercised through delegation to specified agencies which, in turn, empower agents to perform the contracting function. The contracting officer's authority to bind the United States is restricted to the limitations set forth on the appointment warrant, the directives of that department, FAR, Federal statutes, interpretative decisions of the Comptroller General, Courts, and in the final analysis, the Constitution.

7-6. Funding

The fiscal process relating to contracting is a specialized and technical subject, circumscribed by both statutory and administrative controls. These controls place important restrictions, both procedural and substantive, on the conduct of contracting within the Army. No attempt will be made here to review the entire fiscal process and the controls thereon. However, it should be noted that before any officer of the executive branch of the Government can spend public money of the United States, there must have been an act of Congress appropriating the money and defining the purpose for which the appropriation was made. An appropriation has been defined as a statutory authorization to make payments out of the Treasury for specified purposes.

Section II. GENERAL CONTRACTING METHODS, TOOLS, AND TECHNIQUES

7-7. Acquisition Planning

a. While the formal acquisition planning discussed here applies to the more complex and costly programs, its principles are generally adaptable to the acquisition of all supplies and equipment.

b. Acquisition planning is the process by which the efforts of all personnel responsible for the acquisition of defense materiel are coordinated and integrated through a comprehensive plan for the development and production of an individual item or weapon system for the purpose of obtaining a quality product in a timely manner and at a reasonable cost.

c. The program manager (PM) has overall responsibility for acquisition planning in addition to all other planning for the program. The contracting officer or the designee supports the PM by preparing and maintaining the written plan, en-

listing the aid of technical personnel as required. The HCA, in coordination with the PM, must ensure the objectives of the plan are realistic and achievable.

d. The written plan should provide a matrix for the integration and coordination of the efforts of all personnel engaged in the management of the acquisition process, including those engaged in the determination of requirements, development of a technical data package (TDP), funding, contracting, and contract administration. Recommended sample format and content, including the requirement for milestone chart discipline, is set forth in FAR 7.105.

e. Obviously, acquisition planning should commence no later than the initiation of documentation to obtain program approval. As a general rule, the written acquisition plan should be pre-

pared concurrently with the request for program funding.

7-8. Initiation of the Contracting Process

a. The contracting process begins when the contracting officer receives a purchase request (PR) from the requiring activity. When properly prepared and approved, the PR provides the contracting officer with the authority to initiate contracting action.

b. The requiring activity is responsible for ensuring the PR includes or refers to all applicable specifications, plans, or drawings or (if such is not available) for providing a purchase description which adequately specifies all essential features of the supplies or services. It is DOD policy that such technical requirements will state only the actual minimum needs of the Government, be written in a manner which will encourage maximum competition, and will exclude restrictive features which tend to limit competition. In addition, the PR must include the quantity, schedule, delivery point, fund citation, and any other elements necessary to adequately define the requirement.

c. In the review of the procurement work directive (PWD), the contracting officer must ascertain if the requirement will permit maximum competition by assuring adequate review by the procuring activity competition advocate responsibility for promoting full and open competition and challenging barriers to such competition. The contracting officer must determine if the delivery schedule is realistic and, if not, may challenge it. Unreasonable delivery and performance schedules tend to prevent full and open competition.

d. The presolicitation phase culminates in the preparation of the solicitation package. In formal advertising, the package is called the "invitation for bids (IFB)." In negotiation, it is either a "request for proposals (RFP)" or a "request for quotations (RFQ)." The solicitation package includes all the documents and information a firm needs to prepare an offer or a reply to the solicitation. When necessary, it makes reference to places where other items, such as specifications, may be obtained or models may be examined. The package sets forth terms and conditions and the rules for submission of bids, proposals, or quotations.

7-9. Sealed Bidding

a. The Army and DOD acquire products from private industry by two basic methods: sealed bidding and negotiations. The statutory provisions of Title 10 U.S.C. 2304 and 41 U.S.C. 253 cited in

FAR subpart 6.1 require, with certain limited exceptions, that contracting officers shall promote and provide for full and open competition in soliciting offers and awarding contracts through use of the competitive procedures or combination of competitive procedures contained in FAR subpart 6 that is best suited to the circumstances of the contract action.

b. Sealed bidding is an acquisition method which must be rigorously accomplished in accordance with FAR part 14 where, after public opening of sealed bids, award is made to the responsible bidder (defined in FAR, part 9) whose bid is responsive to the terms of the solicitation and is most advantageous to the Government, considering only price and the price-related factors included in the invitation. Sealed bidding is required whenever the conditions in FAR subpart 6.4 exist.

c. Preference for full and open competition has two main purposes—to realize price and other benefits which derive therefrom, and to give all interested and qualified sources an equal opportunity to compete.

d. The success of sealed bidding depends entirely upon the existence of real competition among bidders and upon the integrity of the system. For this reason, each bidder must be treated equally and given the same opportunity to develop and submit a bid. For the same reason, formal advertising procedures are prescribed in detail by law or regulation and cannot be varied. The rigid procedures, and seemingly mechanical operation, are meant to ensure equal treatment of all bidders and to maintain system integrity.

e. No award of a sealed bidding acquisition may be made unless the bids have been solicited and submitted as required by FAR. There are five conditions which must exist to ensure a successful purchase under the formal advertising procedures.

(1) There must be suitable detailed specifications to permit full and free competition.

(2) The requirement must be firm with no changes anticipated in the specifications.

(3) There must be an absence of restrictive details in the specification which would limit the number of bidders.

(4) There must be adequate sources of supply to insure full and free competition.

(5) The acquisition leadtime must be long enough to permit proper solicitation preparation by the Government, the proper bid preparation by each bidder, and proper bid evaluation and award.

f. The contracting officer's evaluation and award decision for sealed bidding requirements is rigorously accomplished in accordance with law and regulation and can be quite complex. After

considering all of the many requirements inherent in the selection phase and by comparing the bids of those contractors who remain in competition (after any rejections because of nonresponsiveness or nonresponsibility), the contracting officer can finally award the contract to the bidder whose bid is in the best interest of the Government, price and other factors considered. Depending on the size and type of the requirement, however, there may be many reviews, approvals, and clearances required before the actual award can be made. Procuring activity competition advocates designed pursuant to FAR subpart 6.5 are responsible for—

(1) Promoting full and open competition in the procuring activity.

(2) Challenging barriers to such competition, including unnecessarily restrictive statements need.

g. Required by FAR, sealed bidding will be used whenever the following conditions are met:

(1) Time permits the solicitation, submission, and evaluation of sealed bids.

(2) The award will be made on the basis of price and other price related factors.

(3) It is not necessary to conduct discussions with the responding offerors about their bids.

(4) There is a reasonable expectation of receiving more than one sealed bid.

7-10. Negotiation

a. The term "negotiation" is used to describe acquisitions from private industry that are made by means other than sealed bidding. By permitting use of negotiation, Congress has recognized not all requirements can nor should be acquired through the rigid process of sealed bidding. For example, negotiations are necessary for research and development of new weapons systems or the production of highly complex equipments, where discussion, clarification, exploration, or modification of contract proposals are essential to obtain a clear understanding by all parties of the nature and scope of the requirements. Negotiation is a procedure that includes the receipt of proposals from offerors, permits bargaining, and usually affords offerors an opportunity to revise their offers before award of a contract.

b. Bargaining, in the sense of discussion, persuasion, alteration of initial assumptions, and positions of give and take, may apply to price, schedule, technical requirements, type of contract, or other terms of a proposed contract.

c. Even though formal advertising may be impracticable because of the absence of one or more of the criteria conditions previously discussed, there are still a number of requirements which

must be met prior to the execution of a negotiated contract.

(1) The negotiated contract must meet the requirements of FAR, part 15.

(2) Any necessary determination and findings to negotiate, etc., must have been made at the appropriate level in a timely manner.

(3) Any necessary business clearances or approvals must have been obtained. (This refers to types of contracts or monetary limitations, use of option clauses, approvals prior to award, etc.)

(4) The prospective contractor must have been determined to be responsible.

d. The contracting officer's award decision for a requirement solicited without full and open competition can be quite perfunctory as long as the sole or limited source conditions are adequately justified and approved at the levels specified in FAR subpart 6.3, negotiations have been satisfactorily completed, and any required reviews, clearances, and award approvals have been obtained.

e. Though the procedures differ and are far more flexible, the actual steps which a contracting officer goes through in the evaluation and award decision for competitively negotiated awards can be quite similar to those formally advertised.

f. A great number of defense acquisitions are simply not amenable to the rigid requirements of sealed bidding. For perspective, it is noted that about 90 percent of all acquisition dollars are spent via the negotiation method.

7-11. Contractual Instruments

a. For the Army, as well as all buyers, the fundamental legal communication with the seller of goods and services is a contract. A contract is simply defined as an agreement between two or more parties which is enforceable by law. It may be written, bilateral (two promises) or unilateral (promise for an act or forbearance to act). Normally, in Government acquisitions, only small purchases may be unilateral; the contractor's promise is performance and the Government's promise is payment for performance. Whatever type or form the contract takes, it must contain the following five valid elements:

(1) Offer.

(2) Acceptance.

(3) Consideration.

(4) Legal and possible objectives.

(5) Competent parties.

b. To provide the flexibility needed in the purchase of the large variety and volume of military supplies and services, a wide selection of contract types is authorized by FAR. The respective contract types vary as to the degree and timing of

responsibility assumed by the contractor for costs of performance, and the amount and type profit incentive offered the contractor to achieve or exceed specified targets.

c. Contracts may be arranged in order of decreasing contractor responsibility for the costs of performance. At one end is the firm fixed-price contract under which the parties agree the contractor assumes full cost responsibility and guarantees performance. At the other end of this range is the cost plus a fixed-fee contract. Under this arrangement, the contractor only promises the best efforts, and the final price to the Government is not guaranteed. In between these extremes, the FAR, part 16, authorizes a variety of incentive contract types which provide for varying degrees of contractor cost responsibility and sharing.

d. The specific type of contract (or combination of types) to be used should be determined by the degree of risk in contract performance. When the risk is minimal or can be predicted with an acceptable degree of certainty (such as for a standard commercial item), a firm fixed-price contract is preferred. However, as the uncertainties become more significant, other fixed-price or cost-type contracts should be employed by the contracting officer to accommodate the circumstances.

7-12. Contract Administration

a. During the pre-award stage of the acquisition, the primary objective of the buying office was to fulfill the requirement in a timely fashion at a fair and reasonable price through the consummation of a contract. The focal point during this stage was the procuring contracting officer (PCO) located at the buying activity. The PCO initiated the solicitation, received offers, conducted any negotiations, and awarded the contract.

b. The execution of the contract marks an end to such pre-award activities and the beginning of

the administration phase in the acquisition cycle—a phase which consists of all actions the Government must now take with respect to the contract until the materiel or services have been delivered, accepted, and paid for, and the contract closed out. It is in the administration phase that the focus of attention generally shifts from the buying activity to the contractor's plant and the Government contract administration office (CAO).

c. Contract management during performance of a contract is the primary responsibility of the CAO. An administrative contracting officer (ACO) at the office is assigned one or more contracts for which he or she serves as the focal point for all contractual matters, administrative as well as technical. Because the ACO may represent a number of PCOs in the administration of DOD contracts with a firm, the ACO is "one face"—a single spokesperson for the Army and DOD to the firm.

d. The Defense Contract Administration Service (DCAS) is a major component of the DLA and is composed of regions which are established in strategic geographic locations across the United States. Each of the Defense Contract Administration Service Regions (DCASR) provide contract administration services in support of the several military departments and other DOD components. These services include contract management, pre-award surveys, quality assurance, payments to defense contractors, support to small business, and surveillance of defense contractor progress to ensure timely delivery of the supplies and/or services.

e. It is the policy of DOD to use, to the fullest extent possible, the contract administration services of DCAS. Each service must limit the retention in buying activities of contract administration functions to only those instances where the benefits derived are clearly demonstrable.

CHAPTER 8 PRODUCTION

Section I. PRODUCTION RESOURCES AND CAPABILITIES

8-1. General

a. An active, modern, and responsive industrial production base is required to maintain military readiness. This crucial industrial capacity is dependent on a balanced array of production facilities owned and operated by both Government and commercial organizations. Planning, coordinating, and operating defense production activities requires multiple systems and procedures for providing current Army weapons and materials and providing for expansion of output in time to meet national emergency and other mobilization requirements.

b. The intensity of planning for production increases directly with the combat essentiality of the item to be produced. Industrial preparedness planning tasks usually falls into one of the following categories:

(1) *Acceleration planning.* Conducted by the Army with a current producer for an increased rate of output for the item being produced.

(2) *Conversion planning.* An arrangement whereby a manufacturer plans to produce, during an emergency, items other than those he or she is currently producing.

(3) *Compression planning.* Plans to enable a current military contractor to maximize production when an attack is assumed to have completely destroyed its source of production resources, or to accommodate conversion planning.

(4) *Subcontract planning.* Plans developed with manufacturers, subcontractors, and suppliers to ensure the flow of subassemblies, parts, and components into the end item assembly plant in cases where a manufacturer obligates a portion of the plant's capacity for emergency end item production.

(5) *Supplier planning.* To identify the various sources of supply and to determine delivery capabilities for commercial-type items which have military application.

(6) *Industrial preparedness measures (IPMS).* Includes other actions to solve potential production problems.

c. The Defense Industrial Plant Equipment Center (DIPEC) of the Defense Logistics Agency (DLA) has, since 1964, provided an inventory redistribution service to Department of Defense (DOD) components concerning storage, utilization, and accountability for broad categories of Government-

owned industrial plant equipment (IPE). This equipment includes such items as milling machines, lathes, drill presses, etc., having a unit acquisition cost of \$10,000 or more. It also manages specific categories of Government-owned special test equipment, such as optical, and laboratory instruments, etc., of like unit acquisition cost. Its basic mission is to foster maximum reutilization of such otherwise idle equipment with savings to the Government. To the extent an item of IPE or special test equipment having a unit acquisition cost of \$10,000 or more is required for performance of a Government contract, and the contractor is unable or unwilling to furnish it at his or her own expense, the Government's procurement contracting officer shall request DIPEC to screen its inventory. If the required item is available, it can be furnished to the contractor for use on the Government contract. In return, the Government obtains either a price reduction on the contract, or charges the contractor rental. When the equipment is no longer needed for performance of the contract, its availability is reported back to DIPEC which will provide disposition instructions. The center also develops standards and specifications for use throughout the Department of Defense in the preservation, maintenance, repair, overhaul, and packaging of industrial plant equipment.

d. DOD emphasis is on obtaining producible hardware. Producibility is being designed into the hardware as a conscious, up front requirement. Efforts are being made to reduce risk by using proven designs for components; statistical process control; and implementation of DOD 4245.7-M, Transition from Development to Production, and its follow on guide NAVSO-P-6071, "Best Practices."

8-2. Government-Furnished Facilities

DOD policy emphasizes contractors provide all facilities in performing on Government contracts, but there are some situations where this is not done and the Government may furnish facilities and equipment to a contractor. These occur when:

a. The item and the production equipment are peculiar to the military and the Government will acquire and retain ownership.

b. The production facility or equipment involved a large capital investment and is, and will continue to be, useful to the Government.

c. The Government, in providing the facilities or equipment, can obtain the required item at a lower overall cost.

8-3. Production Resource Alternatives

a. *Government-owned and Government-operated facilities (GOGO)*. These are usually the result of historical events: either there are no commercial sources because of short runs and small quantities; or there is continuing research, development, and testing being done in consonance with production; or, the element of control is so sensitive that it should remain in Government hands.

b. *Government-owned and contractor-operated facilities (GOCO)*. The element of control is a determining factor here. In addition, cost may be a factor as well as the need for a rapid expansion such as in the production of ordnance or ammunition. The GOCO equipment provided to a contractor is controlled under the provisions of appendix D, AR 310-49.

c. *Contractor-owned and contractor-operated facilities (COCO)*. For most military items and for commercially designed items, this is preferred. Also, there must be an industrial base in the

private sector in order to meet military readiness requirements in the future.

d. *Others*. There are other arrangements available, including facility sharing and provision of Government-furnished materiel (GFM) or equipment (GFE) to a contractor.

8-4. Government-Owned vs. Privately Owned Production Decisions

a. Generally, acquisition from commercial sources rather than Government production of military supply items is favored in defense and Army acquisition policies. Thus, COCO and GOCO production alternatives are used in most cases. But, for reasons of cost, preparedness, security classification, or knowledge transfer of state-of-the-art information, the Army may choose to produce the item at a GOGO facility.

b. These decisions are complex and sensitive. The make or buy and workloading conferences in the Army have to weigh all the qualifying factors as well as follow policy and law when choosing between the production alternatives discussed above.

Section II. PRODUCTION CONTROLS AND TECHNIQUES

8-5. Production Controls

a. Many of the controls which have been found useful in industrial facilities are equally effective in Government facilities. An inventory of raw materials and parts must be on hand in time to be placed on stock records and binned for accessibility during production runs. The required machinery for a run must be both available and in good repair. Work methods must be developed and personnel trained in their use. The procedures for quality assurance, configuration management, cost control, and work measurement must be designed and ready before the production line goes into operation.

b. Managers of production facilities find the problem which causes them greatest concern is keeping all personnel gainfully employed. It is a frustrating experience to find a production line shut down because of a breakdown in a key machine. It is far more frustrating, however, to be forced to stop a production line because of the shortage of raw materials or for parts. There are three major reasons for production stoppage:

- (1) Shortage of raw materials.
- (2) Equipment breakdown.

(3) A delay in delivery of a major component on which the production line depends (or the items of equipment to be overhauled).

A shortage of materials can be blamed on inadequate long-range planning, although delays in requisitioning and acquisition of supplies, and last-minute withdrawals of stocks make this planning extremely difficult. Emergency repair crews and standby equipment are often used to overcome the problem of equipment breakdown. The costs associated with these provisions can usually be justified by the reduction in idle time. Delays in delivery of major components, however, are beyond the control of the manager of a production facility. The manager attempts to retain work in backlog to fill in these gaps.

c. The basis for production control is process planning. Process planning comprises planning for the flow of raw materials, parts, components, tool and machinery planning, and loading and scheduling. Before planning begins, fundamental data must be assembled: How much work is there? What are the quality goals expected? What personnel, tools, and machines are available to do the work? Given this information, lists of materials, parts, and components can be prepared. Next, in planning the flow of the process, it is necessary to consider every feasible alternative, compare alternatives in the light of the other planned production activities, and select the best flow pattern. The next problem is planning of tool and machine

control. Control of tools and equipment used in manufacturing operations is important in all production activities, but it is most essential in intermittent manufacturing. Plans for tooling must be made as early as possible because of the long leadtimes often experienced in obtaining the necessary tooling. It is very rare that production of a new item does not necessitate some tooling changes. For that matter, tooling lists should be reviewed, even for processes which have been accomplished a number of times. There are always deficiencies, and these should be corrected each time a process is repeated. Once tools and equipment are acquired, they must be carefully controlled to see that they are not lost, pilfered, carelessly handled, or improperly stored so they cannot be found when needed. The third aspect of process planning, loading, and scheduling includes assignment of work or equipment to work groups and time-phasing of the process. All the previously discussed planning is prerequisite to loading and scheduling. The need for such a large amount of information makes a good production control system imperative.

d. A variety of production control techniques is available. Typical techniques are bar charts, Gantt charts, and lines of balance charts. Work breakdown charts and network techniques are very helpful in preparing complex schedules.

8-6. Quality Assurance

a. DOD Directive 4155.1 is the policy document for quality assurance effort within the Defense Establishment. It encompasses "cradle-to-grave" concept of responsibilities for ensuring quality. The preamble to the DOD directive states that quality programs will be developed and managed to ensure:

(1) Mission and operational effectiveness and user satisfaction with DOD products.

(2) Conformance to specified requirements by all services provided and products designed, developed, produced, stored, distributed, operated, maintained, or disposed of, by or for DOD.

b. All DOD activities have the responsibility, not only for ensuring appropriate quality requirements are specified, but ensuring contractors or in-house DOD activities performing the work comply with the specified hardware or materiel, specific examinations and test requirements, as well as the level of quality assurance managerial effort required for the particular contract or in-house function or project. Quality programs or inspection systems are designed, implemented, and controlled to assure product quality throughout development, fabrication, and utilization. Development and con-

trol of procedures and processes for initial quality planning, drawings and specifications, inspection equipment, purchase orders, nonconforming materiel, corrective action and feedback, inspection and test, handling and storage, and statistical quality control are primary methods within DOD for assuring quality.

8-7. Cost Control

a. DOD Directive 5000.1 requires that contractor management information/program control systems provide information which is essential to effective management control. DOD Instruction 7000.2 makes Cost/Schedule Control Systems Criteria (C/SCSC) applicable to contracts on programs covered by DOD Directive 5000.1. The only types of contracts excluded from C/SCSC are firm fixed-price and fixed-price with economic price adjustment. In addition, the C/SCSC is applicable to selected critical subcontracts. In such instances, the prime contractor will contractually require the critical subcontractors to comply with the criteria. Functionally, the C/SCSC is not in itself a management system. Rather, it is a set of criteria against which we measure contractor's existing cost and schedule control systems. It represents the acceptance standards for contractor management systems which fulfill the needs of both the contractor and DOD. The basic idea is if the contractor operates a sound cost/schedule system for his or her own use, we should be able to extract summary information from the same system to meet our recurring requirements for contract status information.

b. DODI 7000.2 requires any system used by the contractor in planning and controlling the performance of the contract will meet 35 specific criteria. Two criteria are outlined to help you understand the nature of the requirements for contractor's management control systems.

(1) One criterion requires the contractor to accumulate and control costs on the basis of a product work breakdown structure (WBS). Normally, the Government prescribes the first three levels and requires reporting to the level. The contractor is expected to extend the breakdown until the work is at a level where the first line supervisor can make a reasonably objective evaluation of the accomplishment of work.

(2) Another criterion requires the contractor to break the work into small tasks or short span work packages. If a work package covers a long period of time, an assessment of progress at any given point in the performance of the work package would be a subjective determination. It is better if there are milestones during a long work

package and if for each milestone a predetermined value of work accomplished is assigned. Then when the milestone is achieved, there can be a more objective determination that a specified amount of work was actually accomplished. Another method which achieves greater precision is the short span work package. In large development contracts, these should cover 3 months or less.

(3) One very important aspect of the criteria is that progress be based on the amount of work which is actually accomplished as opposed to the amount of resources expended. A method commonly used to control cost performance has been to compare actual costs with budgeted costs. This approach simply reflects whether resources are being expended faster or slower than the rate at which they were planned to be spent and can be misleading. What is needed for a meaningful determination of cost status is a comparison of the actual cost with the value (or planned cost) of the work performed.

c. In brief, C/SCSC is applied to help ensure our large contractors have adequate internal visibility, and control and project managers obtain and use valid objective data relating to cost and schedule progress early enough so that visible alternatives are available other than requesting additional funds.

8-8. Configuration Management

a. Configuration management identifies, controls, accounts for, and audits the functional and physical characteristics of systems, equipments, and other designated materiel items. Configuration management is the basis for controlling changes made to equipment designs.

b. Detailed information regarding configuration management is found in AR 70-37, MIL-STD-480, and MIL-STD-481.

8-9. Resources Controls

Production managers must plan the use of manpower, raw material, and production equipment before production begins.

a. Manpower must be hired and trained to perform the required tasks using appropriately developed work methods. Work measurement techniques and work simplification procedures should be developed as an aid to cost control.

b. The correct quantities of raw materials and subassemblies for production or assembly must be ordered, programmed, identified, and placed in the correct place along the assembly line. The absence of any materiel or component can cause production stoppage unless adequate planning has slack programmed into the production process.

c. Planning must incorporate the need for the acquisition and maintenance of production equipment. As production equipment has a long acquisition leadtime, detailed planning is required long before expected production time. Maintenance crews and standby equipment can be used to avoid production shutdown in the event of equipment stoppage.

8-10. References

a. Army Regulations (AR).

18-1	Army Automation Management
37-40	Army Production Base Support Program Report
37-100	Account/Code Structure
70-1	Systems Acquisition Policy and Procedures
70-10	Test and Evaluation During Development and Acquisition of Materiel
70-37	Configuration Management
71-3	User Testing
71-9	Materiel Objectives and Requirements
600-50	Standards of Conduct for Department of the Army Personnel
700-9	Policies of the Army Logistics System
700-43	Defense Industrial Plant Equipment Center Operations
700-90	Army Industrial Preparedness Program
715-11	Army Procurement Management Review Program
750-26	Quality Assurance Program: Storage/Maintenance of Industrial Plant Equipment
1000-1	Basic Policies for Systems Acquisition

b. Department of the Army Pamphlet (DA Pam).

11-25	Life Cycle System Management Model for Army Systems
27-153	Procurement Law

PART FOUR: SUPPLY

CHAPTER 9

INVENTORY MANAGEMENT

9-1. General

The management of inventories is central to Army logistics management. Army operations depend on supplies; the flow of these supplies depends upon the effectiveness of the management of inventories for many months prior to the issue of the supplies. During the research and development (R&D) of materiel, an important aspect is the engineering estimation of equipment failure rates and the corresponding requirements for repair parts. This, coupled with distribution planning for new equipment, is the beginning of inventory management during the materiel life cycle. The job of wholesale inventory management in the Army focuses on the responsibilities of materiel readiness/commodity commands. Essentially, the responsibilities of the materiel readiness/commodity commands include cataloging, requirements computation, acquisition direction, distribution management, maintenance management, stock control, and materiel utilization and disposal management. These responsibilities are discussed in paragraphs 9-17 through 9-24.

9-2. The Objective of Inventory Management

The objective of inventory management is effective, efficient, and economical supply of the combat soldier. With the many compromises and trade-offs which are necessary in the operation of Army logistics, this ultimate objective can become obscure, for at all levels of the supply system there are limitations on the resources of logistic—transportation, facilities, and labor, as well as materiel. Logistics managers specify standards for materiel support which will ensure an acceptable level of service to supported units, and managers repeatedly examine every operation in the system in an attempt to balance available resources to reach or surpass the defined standards. However, even with the best possible management practices, emergency supply actions are often necessary to meet unpredictable contingencies. The standards set for any operation serve as guidelines for operating personnel and control indicators for management, but success in supporting the troops must always be the ultimate criterion for evaluating the supply system.

9-3. Major Organizational Considerations

a. Overall policy governing inventory management is developed in the offices of the Secretary of Defense, the Secretary of the Army, and the Army General Staff. Each of these offices also controls expenditures

and exercises selective management over critical items of materiel. Operating policy and additional controls over the flow of supplies are applied by Headquarters, U.S. Army Materiel Command (AMC); Office of the Chief of Engineers (OCE); and Office of The Surgeon General (OTSG). The principal inventory management activities are the materiel readiness/commodity commands under AMC, the Defense Logistics Agency (DLA), and the General Services Administration (GSA). Worldwide inventory management focuses at these points.

b. The Federal Supply Service and the Defense Supply Centers (DSC) perform inventory management functions for GSA and DLA, respectively. Service Item Control Centers (SICC) serve as the point of exchange of inventory management information between the Army and GSA, DLA, and other military services for those items required to support contingency plans and mobilization plans and which are managed by these agencies and military services.

c. In oversea theaters, policy direction comes from unified command headquarters and theater Army headquarters. At this level of organization, inventory management functions include determination of requisitioning objectives, managing requisitions, replenishing stocks in general support (GS) storage locations, directing offshore acquisition, and managing the distribution of supplies. Overhaul, when authorized in an oversea theater, must be coordinated with appropriate requirements agencies in the Continental United States (CONUS). The materiel management center (MMC) at theater Army, Theater Army Area Command (TAACOM), Corps Support Command (COSCOM), and Division Support Command (DISCOM) provide supply and maintenance management to their commands.

9-4. Approaches to Analyzing Inventory Management

a. There are a number of factors which produce management distinctions in the supply systems. These distinctions sometimes resemble separate systems and can cause confusion unless the controlling factors are thoroughly understood. Four approaches to viewing the supply system are listed below and are discussed in detail in FM 710-27.

- (1) By criticality of materiel.
- (2) By the environment in which supplies are to be used (including the distance from the supply source).

(3) By the capacity of the system to generate demand data (i.e., the ability of the user to prepare formal requisitions).

(4) By class of supply.

b. One or more of the above approaches to viewing the supply system may be useful in the analysis and solution of supply problems. Logistics managers must continuously evaluate the effectiveness of the supply system. In searching for means to improve the system, stockage points may be consolidated, central data banks established, or new management controls imposed; but all changes must be considered in the light of every related aspect of the system. Viewing each problem or proposed system improvement from several points of view will help ensure a coordinated solution.

9-5. Fiscal Processes and Inventory Management

a. The dollar, a common denominator for processes, as well as items of materiel, can be a useful management tool for any level of supply management. Although inventory managers from the materiel readiness/commodity commands down must focus on item control rather than dollar summaries, financial summaries can assist them, especially in establishing and maintaining the vitally needed close coordination with Comptroller activities. First, however, the relationships between stock funds and consumer funds must be understood.

b. Materiel is acquired through the use of procurement appropriations and is distributed to users for consumption through consuming appropriations. Army Procurement Appropriations (APA) and Army Stock Fund (ASF) are examples of procuring appropriations. Operation and Maintenance, Army (OMA), and Military Personnel, Army (MPA), are consuming appropriations. Items purchased with APAs are distributed to units "free" (i.e., without use of consumer funds), whereas, items procured with funds from the ASF are brought from the stock fund by units with their consumer credits.

c. Working capital funds (stock funds) have been established to separate accounting for inventories from accounting for consumption. Stock funds provide interim finance for, and hold in suspense, costs of consumable materiel until items are issued to consumers and costs are recovered from consuming appropriations. The materiel readiness/commodity commands "sell" materiel, and with the receipts from sales, replenish their stock funds and are thus able to procure more secondary items. The materiel readiness commodity commands usually sell their items to a retail stock fund of a major command which, in turn, sells to units and is reimbursed by consumer funds (e.g., OMA funds).

9-6. Purposes of Inventory

The principal reason for maintaining inventories is to improve customer service by compensating for time needed to produce, handle, and ship supplies. If goods are on hand, a customer may draw them as needed. If, however, goods must be shipped a considerable distance or even manufactured before they can be provided to the customer, the resulting delay may produce serious consequences on the customer's operations. Some of the inventory is also maintained for protection against uncertainty. None of the time factors involved in acquisition and delivery of goods is constant. Furthermore, the customers' needs for goods are, in most cases, variable. Stocks must be maintained at a level which will ensure units will be supplied with their needs an acceptable percentage of the time.

9-7. Cost of Inventories

a. The need for inventories must be continuously weighed against the costs of inventories. Inventories have an initial acquisition cost which includes, in addition to the cost of the items, certain ordering costs such as the costs of requirements determination, contracting, and contract supervision. In addition, the cost of shipping can be traded against the cost of keeping materiel in storage. For example, where the weight, cube, and dollar value permit, the higher cost of air versus surface shipment of goods can be balanced against the savings made possible by the feasibility of reducing the size of inventories in view of the faster resupply response of air shipment. Some costs of keeping materiel in storage or holding costs are: interest on the investment in stocks, the cost of warehouse space; the salaries of personnel who operate warehouse and control activities; and the costs of acquisition and maintenance of materiel handling equipment (MHE). Other holding costs result from pilferage and deterioration of goods as well as loss when goods become obsolete in storage.

b. The holding costs of inventories can be used by Army logistics managers as a management tool in much the same way as they are used by industry. Holding costs are a good indicator of efficiency in management inventories; they can be related to a storage space, total sales, inventory turnover rates, etc. In industry, they bear a direct relationship to profits and are controlled with the goal of maximization of profits. In the Army, however, the emphasis is on the use of costs as a management tool to achieve the management goal of optimum effectiveness in support of troops.

c. In evaluating costs of inventory, one of the most important costs, as well as the most elusive, is the cost of not having the item in stock. The cost of downtime, the cost of providing a substitute item to the customer,

and the possible consequences of failure to fully support the combat soldier must be weighed against the cost of holding an item in stock.

9-8. Selective Management of Inventories

One of the goals of inventory management is to focus management resources at those points in the supply system where the greatest benefits will be gained. It is not practicable to attempt application of the same level of management to each of the hundreds of thousands of different items in the Army inventory. One method used by both industry and the Army is to separate items into cost categories. It is generally true that a small number of the total items carried in stock represents a major portion of the total dollar demand. In terms of lowering inventory holding costs, careful management of the relatively few very high or high-dollar value items is most economical and has the highest potential for return on the dollar spent. A less intensive technique for management of the medium-value category is also practicable and has a reasonable payoff. The low-dollar value items, however, can be managed largely by computer without incurring much of the monetary risk. The considerations, it should be emphasized, are based on dollar economy and not on service to the customer. However, when the needs of troops are considered, the dollar economy to the Army as a whole may call for incurring higher inventory costs.

9-9. Demand Patterns

A "demand" for an item is a request for an item. In industry, demands usually take the form of purchase orders from customers and, in the Army, of requisitions from units. (In the Army, demand is, under certain circumstances, predicted and responded to automatically without submission of requisitions.) When demand is plotted against time, it may be found to be fairly constant or trending upwards or downwards. Demand data can also exhibit a cyclical pattern characterized by a number of peaks and valleys that tend to occur at regular intervals. In some cases, these cyclical patterns correspond to seasons, and in other cases a seasonal pattern is superimposed on a cyclical pattern.

9-10. Forecasting Demand

a. Demand forecasting is important largely because of the leadtimes involved in procuring and distributing items. The longer the leadtime, the more difficult it is to estimate the demands which will take place in that period. The procurement leadtime seems to be one of the least understood aspects of the supply system. If an item ordered by a unit is not available in any of the levels of stockage, it must be procured. If the item

must be fabricated, a contractual process involving advertising or negotiation is necessary. After the contract is signed, the company which will furnish the item must fit the manufacturing of the item into its schedule, obtain the necessary raw materials, and perhaps procure tooling for the item. The administrative processes necessary to complete the acquisition contract may take several months, depending on the workload of the acquisition office and the priority of the requirement, and production may require anywhere from a few months to several years. To make the management of the acquisition process even more difficult, production time may vary widely from order to order. Thus, in forecasting, managers must often look years into the future.

b. Demand forecasting is usually based on a probability method, except for those items where demand is uniform and unchanging. It may be based on demand history or when the history is inadequate, on engineering estimates of these demands. Another technique is to base forecasts on the planned use of equipment. These plans could be operational plans or equipment distribution plans. The more specific they are, of course, the better. The operating-hour programs for specific equipment are especially useful types of plans. In the following paragraphs, a few techniques for analysis of historical demand will be discussed. These techniques are used by both industry and the Army for items such as repair parts when a history of demand is available.

c. The "moving averages method" is a demand forecasting technique in which a variable number of periodic (e.g., monthly) records of quantities of items requisitioned are averaged for an estimate of the demands for the next period. If this average is taken over a relatively short period of time (e.g., 6 months), the forecast is more responsive to recent demands than if the average spans a longer period (e.g., 24 months). This gives the analyst a simple mathematical device for manipulating demand projections based on his or her judgment of the importance of trends in the demand history.

d. When examination of demand data accumulated over a period of time indicates a changing demand pattern, i.e., trend to higher or lower values, demand may be forecast by constructing (graphically or mathematically) the line or curve which represents the demand trend and extending this line or curve into the future. A mathematical technique applicable for lines is called the method of least squares. Briefly stated, the method of least squares is designed to estimate the beginning demand level and the rate of change of a straight line which best represents recorded demand over a period of time. The extension of the line rep-

resents the demand projection for future periods. When the plotted data follow a uniformly changing curved path, a curve can be fitted to the data using more advanced mathematical techniques.

e. Exponential smoothing is a statistical technique which is a refinement of the moving-average technique. Where the moving-average technique places equal weight on grouped data in a given base period, the exponential smoothing method gives increasing weight to more recent data in a given base period. Three figures are required for exponential smoothing the demand which was predicted for the last period (e.g., month); the actual, recorded demand for the same period; and a factor called a smoothing constant. The predicted demand for the last period usually was obtained at the beginning of the period by a similar exponential smoothing computation, though it may have been obtained by the moving-average technique.

9-11. Fixed and Variable Safety Levels

a. Safety levels are established as a degree of protection against a stock depletion during the time an order is due in, due to unusual demands or delays in delivery from the producer. Fixed safety levels are determined arbitrarily, while variable safety levels are determined based on probability principles and on analysis of historical data.

b. Fixed safety levels based on days of supply considered adequate to cover demand fluctuations are easy to administer but have the disadvantage of not giving commanders a means of establishing standards for demand satisfaction. It is not economical in terms of balancing the utilization of resources to aim for 100-percent demand satisfaction. A commander must decide upon the percentage of demand satisfaction that must be both feasible and acceptable.

c. Variable safety levels are based upon the degree of protection desired against stock depletion. Computation of variable safety level quantities is accomplished through the use of statistical methods. For example, the computation considers such data as the frequency of demands, the size of the average order, the length and predictability of leadtimes, and reorder frequencies. There are many advantages to the variable over the fixed safety level such as, increased consideration of historical data, more meaningful basis for reacting to budgetary constraints, better measurement of system performance, and greater flexibility in determining protection on an item-by-item basis.

9-12. Economic Order Quantity

a. An order quantity is the number of units procured from a vendor in a single order. Through demand forecasts, logisticians predict materiel requirements

over a period of time. However, many factors must be considered before placing orders to meet these predicted requirements. Economic order quantity formulas may be used to minimize the sum of ordering and holding costs. It can be shown mathematically that when marginal holding costs equal marginal ordering costs, the sum is minimized. Variations of this approach frequently are used to compute when to reorder, and how much to reorder. Normally the calculations are computerized.

b. The above discussion is concerned with the simplest conditions for calculating the economic order quantity. The computation depends on the accuracy of data on ordering and holding costs and on the consistency of demand rates. It considers neither safety levels nor the cost of stockouts, quantity discounts, and other factors. Even with these more sophisticated approaches, subjective judgment is required in extreme cases of very large or very small buys. An economic order quantity may be calculated to be 5 years or more of supply; however, although this calculation may be correct based on present data, the practical inability to make long-range predictions with complete confidence necessitates a limitation in the size of the total economic order quantity acquisition. Conversely, the formula can indicate purchasing frequencies in excess of one per month. To avoid overloading purchasing offices, however, a minimum reorder cycle should be specified. In addition, cost determinations are often difficult and results questionable, and once the factors used in calculating an economic order quantity have been determined, they tend to remain lodged in the system. For these reasons such factors as holding costs and ordering costs often are used as parameters to be adjusted to make the system behave reasonably, rather than as correct costs. Consequently, economic order quantity acquisitions should be placed under management-by-exception controls.

9-13. Divisions of Responsibility

To understand the complex and time-consuming administrative demands placed on inventory management activities by higher authorities, it is helpful to visualize the roles and responsibilities of the Secretary of Defense, the Secretary of the Army, and the Army Chief of Staff which are directly related to Army inventory management.

9-14. Management by the Secretary of Defense

a. The Secretary of Defense has an obligation to achieve his mission of strategic preparedness as economically as possible. Some of the methods he uses to achieve this economy include balancing resource allocations, intensive management of critical materiel

items and systems, and logistics and force guidance designed to counter foreseeable enemy threats. The stratification of inventories according to mission objectives is another technique by which the Secretary of Defense controls the development of inventories to meet potential contingencies. Secondary items are stratified to distinguish between inventories held for peacetime operating needs, for war readiness, for special projects, or as "economic retention" stock. The Department of Defense (DOD) programs for the screening and disposal of surplus property and coordinates the efforts of each service to identify and declare as excess those stocks on hand which are beyond the needs of any of their inventory requirements.

b. Title 10 of the United States Code specifies that funds may be obligated for acquisition, production, or distribution of supplies, or for related functions of supply management only under regulations prescribed by the Secretary of Defense. The Secretary of Defense has taken decisive action in response to the intent of Congress in this and in other laws. Through directives and instructions, he has established governing policies (in some cases, procedures) for all of the activities of supply management. In addition, he has established a number of department-wide programs designed to effect economies and improve coordination. Some principal programs are:

- (1) Integrated management of common supplies and services.
- (2) The Federal Catalog and DOD Standardization Programs.
- (3) The Coordinated Procurement Program.
- (4) The Defense Reutilization Program.
- (5) Retail Interservice Logistics Support Program.

9-15. Policy and Guidance for Major Items Funded by Procurement Appropriations, Army (PAA)

a. All military services give primary management attention to equipment and weapon systems such as aircraft, ships, combat missiles, and armament. In the Army, these items are referred to as major items. These items are procured with PAA funds. Most secondary items, on the other hand, are procured with stock funds; however, some are procured with PAA funds. The annual cost to manage an item as a major item is much greater than managing it as a secondary item. Because of the cost of the highly intensified management of a major item, an item must meet the following criteria before it is classified and managed as a major item: Major items are those items which are assigned a Line Item Number in SB 700-20 and

which are assigned to Supply Class VII and have an Appropriation and Budget Activity Code of "A" through "Q".

b. The preparation of the Defense Guidance (DG) by the Secretary of Defense is considered the initial action each year in the national level involvement in major item management. The Joint Chiefs of Staff (JCS) use the DG to prepare their Joint Program Assessment Memorandum. The DG is also used by the military departments and defense agencies to prepare their individual Program Objective Memoranda (POM). Following the submission to and reviews by the Secretary of Defense of both the Joint Program Assessment Memorandum and POM, he issues a Program Decision Memorandum (PDM). This memorandum is used to update the Five-Year Defense Program (FYDP), and it is used by the Assistant Secretary of the Army for Research, Development and Acquisition (ASARDA) to update the Army Planning Policy Guidance. It is also used by the Deputy Chief of Staff for Operations and Plans (DCSOPS) to develop the Structure and Composition System (SACS) data. All of these are key inputs to major item requirements determination.

9-16. Major Item Procurement Process

a. The budget estimate for PAA funded major items is initiated through the preparation of an Army Materiel Plan (AMP). This is developed after the determination of major item requirements has been completed as discussed in paragraph 9-19.

b. The draft budget, AMP, prepared by the major subordinate commands, is reviewed in joint conferences by ASARDA, AMC, and readiness command personnel. During these conferences, changes and corrections are made after which the readiness commands prepare a second draft of the budget AMP. A magnetic tape of the second draft is forwarded to the ASARDA Information Systems Agency (RDAISA) for use in developing its budget file. After an interchange of information and guidance between RDAISA, ASARDA, AMC, and the readiness commands, the PAA-funded major item portion of the Army budget estimate is developed. Based on this budget data, the readiness commands publish their final budget AMP, and prepare preliminary acquisition/production plans. These ultimately become a part of the President's budget.

c. About the same time as the President's budget is submitted to Congress (usually in January), the development and processing of the appropriation AMP is started. The procedures for preparation and processing are basically the same as described for the budget AMP in *b* above. This is

merely a plan showing how the Army intends to distribute and use the PAA funds once they have been appropriated by Congress.

d. The execution of the major item procurement process begins with the Office of Management and Budget's (OMB) apportionment of the defense funds appropriated by Congress. DOD, in turn, releases the programs and related funds to the Department of the Army (DA). Frequently, the amount of funds appropriated does not match the amount requested in the initial budget estimate and/or during the budgeting and apportionment process restrictions are placed on the use of funds. Therefore, many changes are made on the various programs and the allocation of funds becomes more definitive as the process moves from ASARDA and HQ, AMC, down to the materiel readiness/commodity command level. ASARDA allocates the funds by budget line item numbers which appear in the P-1 Exhibit of the President's budget. At the AMC level, fund suballocations are made by Procurement Request Order Number (PRON) which AMC assigned to the various procurement programs. At these commands, they are allotted to the individual major item managers by standard study number (SSN) and line item number (LIN). Upon receipt of the allotted funds, the major item managers are in a position to prepare funded procurement work directives and submit them to procurement and production. The procurement and production personnel, in turn, initiate procurement actions and award the contracts. (At MICOM, the Missile Logistics Center System Management Office is responsible for major item procurement).

9-17. The National Inventory Control Points (NICP)

Army inventory management is exercised by the NICPs at the materiel readiness/commodity commands of AMC. Limited inventory management functions are also performed by the Army Information System Command and OTSG. These inventory management activities of the Army are responsible for the worldwide supply support for those items they manage, and perform some or all of the following functions which are discussed in detail in FM 710-27.

- a.* Cataloging direction
- b.* Requirements direction
- c.* Acquisition direction
- d.* Distribution direction

- e.* Maintenance direction
- f.* Materiel reutilization and disposal direction

9-18. Cataloging Direction

a. The United States Federal System of Item Identification as explained in DOD 4130.2-M, Federal Catalog System Policy Manual was adopted by North Atlantic Treaty Organization (NATO) Standardization Agreements (STANAGS) 3150 and 3151. The purpose of these actions was to provide a uniform system of supply classification for use by the NATO Armed Forces. These agreements provided for the adoption of the United States Federal System of Item Identification as the basis for the NATO Item Identification System. To implement these agreements, which the United States ratified, and to implement the system, the Secretary of Defense directed the term NSN be used among and between American forces. Thus, it will be the same as the NATO Stock Number (NSN) which will be used when addressing NATO and other friendly foreign countries. The National NATO Stock Number has 13 digits instead of the 11 in the former U.S. Federal stock Number. The first four digits of the NSN represent Federal Supply Class (FSC) and the next nine digits are the National Item Identification Number (NIIN). The first two digits of the NIIN represent the country of origin. The United States has been assigned National Codification Bureau (NCB) Codes "00" and "01." The NIIN will always be a nine-digit number and cannot be broken down further.

b. A record must be kept of all numbers as long as the item is included in a current technical manual applicable to Army-used items or Army-supplied items for Security Assistance Programs. The following sequence of events illustrates how an item may, during its life, be identified by several different numbers. During the R&D process, an item is often assigned a management control number (MCN). When the item is accepted and approved for acquisition, the MCN is dropped and NSN assigned. During the life of the item, it may, for management reasons, be shifted one or more times to different Federal supply classifications. As a result of screening processes, an identical item carrying another NSN may be discovered. The new number may then be eliminated and the item ordered under the former stock number. Thus, since an item may be known under several stock numbers, records should be kept in such a manner that an item can be identified regardless of the stock number used.

9-19. Determination of Requirements for Major Items

a. DCSOPS provides to the Research, Development, and Acquisition Information System Agency (RDAISA) a series of magnetic computer tapes containing the data developed via SACS. The data contain a listing of all equipment needed by the force which was structured in the Army's POM, as modified by the PDM. In addition, the ASARDA Planning and Policy guidance (PPG) includes instructions for the computation of post D-day consumption (war reserve requirements), maintenance float, and certain operational projects. RDAISA computes these additional requirements using the initial issue quantities furnished by DCSOPS, the PPG, and the SSN data base provided to RDAISA by LPSA which provides maintenance float factors, replacement factors, and other information. This Army Procurement Requirement process results in the development of the Army Acquisition Objective (AAO) which is the quantity of a major item, required to initially equip and sustain the U.S. Army approved force and certain allies during time depicted in Defense guidance.

b. RDAISA provides the AAO to the AMC major subordinate and this quantity serves as the target for acquisition of the major item. During the AMP process, the AAO is compared to the forecasted asset position (current assets plus dues in from production minus forecasted losses). The difference between the AAO and forecasted asset quantity is the net procurement requirement.

c. The major item worldwide asset position is determined by LPSA through use of the Continuing Balance System Expanded (CBS-X). Its objectives are to enable the Army to compute the worldwide inventory on a timely basis and to identify and reconcile differences between reported assets and the computed asset position.

9-20. Determination of Requirements for Secondary Items

a. Secondary items are items not identified for the rigid management controls specified for major item control. These are procured by the procurement appropriations.

b. Much of the activity at the NICP focuses on the determination of requirements for secondary items. Approximately 300,000 Army-managed secondary items are regularly stocked in the Army depot system. The majority of these items have an annual acquisition value of \$5,000 or less.

c. The materiel readiness/commodity commands must manage so many items it would be totally impracticable to manage each item intensively.

The Army approached secondary item management as a combination of selective management by dollar value of forecast gross annual demand and management-by-exception techniques. Selective management is a means of inventory control which provides precise control over items selected for close attention generally because of their high-dollar value, and for eliminating all but the most necessary details in the management of low-dollar or low-volume materiel. The cost of management has a direct relationship to the importance and the cost of the item. The policy separates all secondary item demand into four categories for the application of varying degrees of management. These are:

(1) Low-dollar value items (\$25,000 or less annual acquisition program).

(2) Medium-dollar value items (over \$25,000 but not more than \$100,000 annual acquisition program).

(3) High-dollar value items (over \$100,000 but not more than \$1,000,000 annual acquisition program).

(4) Very high-dollar value items (over \$1,000,000 annual acquisition program).

d. The principle of management by exception is exercised whenever an item becomes critical. One technique is to shift a critical item into another category for closer management control. For example, a low-dollar value item may be shifted to the medium- or high-dollar value category and, thus, automatically receive more frequent and more thorough analysis. In other cases, groups of items (usually related to one or more critical end items) will be placed under control of an individual manager for close management until such time as the items are no longer creating special problems.

9-21. Acquisition Management

a. Much of the effort of acquisition management can be taken over by the computer. There is no need for a supply manager to spend time preparing an acquisition request when the computer has performed the supply control study and can continue with the printing of the request. The acquisition request must, however, provide all the technical information needed by the acquisition office to prepare a contract. There is a danger, though, that in this automatic process for preparing acquisition requests, excessive frequency of acquisitions may go undetected. This could occur as a result of a failure of the computational technique to compensate for radical changes in demand patterns. The automatic acquisition technique saves valuable supply management time, but it must not be allowed to increase the workload of the equally valuable acquisition specialist.

b. DOD policy calls for making secondary item acquisitions on an economic order quantity basis. Typical economic order quantity practices result in buying item quantities which range from 3 months to 36 months of supply, depending on cost to hold, cost to buy, and other characteristics.

c. It is essential that managers realize there is likely to be a shortage of stock funds whenever there is a buildup prior to major operations. Alert supply managers realize they must initiate acquisition actions for materiel to support the impending operations; however, they are not "selling" the stock which they have in their depots at an accelerated rate because the increase in demand from the operation will not materialize for some time in the future. Therefore, the stock fund cash is depleted by purchases and not replenished by sales. Thus, at the first evidence of escalation of operations, managers must begin planning for requests for additional stock fund obligation authority and cash, as required.

d. Inventory managers should be sufficiently familiar with acquisitions techniques so they can identify situations in which management time can be saved. Some of these techniques are also useful for postponing the obligation of funds when there are serious constraints. This arrangement is ideal from the standpoint of both acquisition and supply management. Funds for the entire forecast requirement need not be obligated. An obligation occurs only when an order is placed against the contract. For the contracting personnel, this means one basic contractual arrangement, possibly covering many items. Blanket purchase agreements are also useful. Such agreements allow repetitive orders to be placed with one contractor. The contractor, in turn, bills Government once a month for all orders placed during the month. Another technique is the contracting for one-half of the calculated requirements and providing for the pricing of option quantities of 100 percent, 50 percent, and 25 percent. This procedure is of considerable value to the supply manager as it allows the complete calculation of total requirements but does not obligate the total dollar amount. When the reorder point is reached, options on the existing contract may be executed.

Variations in acquisition leadtimes are a source of frustration for supply managers. Acquisition leadtime is one of the most significant factors in calculation of the requirements objective; yet, from order to order this may change. Some of this variation is the result of using different contractors under competitive contractual arrangements; but even a single contractor's production time will vary depending on the production schedule and

other factors. This variation can be the source of critical shortages and, therefore, should be analyzed carefully as a routine management consideration.

9-22. Distribution Direction

a. The Major Subordinate Commands are responsible for the initial distribution of items coming from the manufacturers as a result of acquisition actions. The distribution pattern becomes a part of the acquisition packet. The manufacturers need these data to develop realistic bids for producing items, particularly those items for which the first destination is to be included in the cost. The management of the physical distribution of the items after they are delivered to the Army depot system is different for the secondary item distribution than it is for major item distribution. Requisitions for both are processed in accordance with AR 725-50.

b. Requisitions from customers in the field are submitted to the appropriate National Inventory Control Point (NICP) where they are edited and processed. If assets are available for issue at a CONUS depot, materiel release orders are automatically printed and sent to the depot. Upon filling the requisitions, the depot will submit materiel release confirmation to the NICP where stock record accounts are adjusted. Item managers become involved in this process on an exception basis only. For example, requisitions for items in critical stockage position, controlled or regulated items, and items managed under the selected item management—expanded (SIMS-X) may be sent to the item managers for approval of their release. Subordinate command secondary item managers also direct the redistribution of assets for SIMS-X items as prescribed in AR 710-1.

c. Major items are distributed according to AR 11-11 (c), AR 11-12 and AR 710-1. Priorities for distributing major items originate from two sources. The Army Order of Precedence (AOP) which is a DA approved sequence of directed actions. It is combined with the Equipment Readiness Code/DA Master Priority List (ERC/DAMPL) file for input into the Total Army Equipment Distribution Program (TAEDP), produced by LPSA. The TAEDP provides automated data products to HQDA, Major Army Commands (MACOMs) and MSCs for use in planning and coordinating long range distribution programs. The same priority system is used by LPSA to generate a number of products used to execute major item distribution actions. These Equipment Release Priority System (ERPS) products are designed to tell major item managers the sequence in which to release avail-

able equipment to identified shortages. ERPS priorities are also being used by a process of the Commodity Command Standard System (CCSS) called MIRV (Major Item Requisition Validation) to automatically sequence validated major item requisition in accordance with AOP and ERC/DAMPL priorities.

9-23. Overhaul/Rebuild Direction

a. Whenever the worldwide on hand asset position becomes less than the authorized requirement, the materiel readiness/commodity command item managers must satisfy the shortages by either having an unserviceable asset overhauled and returned to serviceable stock, or by purchasing new items. In choosing between overhaul or acquisition as the replacement method, the item managers must consider factors such as acquisition costs versus overhaul costs, maintenance expenditure limitations, leadtimes for acquisition versus overhaul leadtimes, the need for maintaining a warm in-house maintenance base versus a warm production base, and repair parts availability. All the above factors must be weighed against the needs of the customers.

b. If the secondary item is CONUS depot reparable, the materiel readiness/commodity command secondary item managers must consider the on-hand and potential unserviceable assets which will become available during the supply control study's projected time frame. The planning time frame for CONUS depot overhaul of reparable unserviceable items covers the current budget and POM years. However, for some long overhaul leadtime items, it is necessary to consider a 3-year period (current and budget plus 1 year).

c. The major items CONUS depot maintenance process covers 1 year execution (current year) and 5 years planning (budget + 4 years). The major item managers begin their major item depot maintenance planning for a given fiscal year 5 years prior to the start of the fiscal year. Initially, an estimated gross depot maintenance requirement is determined at the same time the managers determine their gross and program requirements. These initial gross depot maintenance requirements are submitted to the materiel readiness/commodity national maintenance point (NMP) or (NICP) after which they are reviewed and refined and, finally, become a part of the depot maintenance program. The DESCOM central workloading activity prepares the budget and apportionment depot maintenance program which is processed through the budget and apportionment cycles along with the

AMP. At the same time as the central workloading activity is preparing the maintenance program, it is also workloading the depots. When the execution year finally arrives, it is the responsibility of the materiel readiness/commodity command major item managers to ensure the unserviceable major item assets are available as planned and programed to ensure, through coordination with the responsible secondary item managers, repair parts are available to support the major item overhaul program.

9-24. Materiel Utilization and Disposal

Excess stocks are an extravagance the supply system cannot afford. They take up space; they require maintenance to prevent deterioration; and they reduce the efficiency of depot operations. "Retention" levels are established for stocks. The retention level is the total quantity of an item which is authorized to be held in stock. The retention level includes mobilization reserve, safety, economic retention, contingency, allied force, and sometimes other stock quantities in addition to the quantity to support ongoing operations. Stocks over the sum of these quantities are potential excess. Excesses occur as a result of demand predictions which do not fully materialize, or equipment obsolescence. Items identified as "potential excess" are reported for possible use by other services. The basic policy of the DOD disposal program is to promote and ensure the most effective utilizations, conservation, and marketing of Government-owned property. To achieve this goal, close cooperation of inventory managers, stock control personnel, and disposal activities are necessary.

9-25. Inventory Management Below the National Level

The major analytical functions of inventory management are conducted at the national level. A general discussion of the principles of supply management below the national level is necessary to illustrate the application of inventory management approaches to supply management at lower levels. Also, the analytical techniques at the national level are very much dependent upon supply management exercised at the lower levels. Therefore, this section provides a general discussion of installation and field organizational supply management with emphasis on those processes which are particularly significant to inventory management at the national level.

9-26. Inventory Management at Installations in CONUS

a. At installations, the supply management functions concerning all but medical materiel are centralized in a consolidated property office or supply directorate. Except for specified types of materiel (e.g., mission-essential, direct support system (DSS) customer stockage, maintenance float, authorized standby), items to be stocked are selected on the basis of the number of demands generated over a 1-year period. This list of items which may be stocked is called the authorized stockage list (ASL). "The criteria for adding items to the ASL is determined by application of Retail Inventory Management and Stockage Policy (RIMSTOP). RIMSTOP evaluates each item based on such factors as essentiality, cost to store, cost to order and unit price to determine the number of demands required for addition to the ASL." All requisitions are recorded in the computer file or manual stock records, and items are promptly added to or deducted from the ASL.

b. Stock levels may be established in terms of days of supply or on the basis of "economic inventory policy." The economic inventory policy concept of inventory management is designed to improve efficiency of installation supply operations by eliminating unnecessary accounting efforts. The concept consists of three elements:

- (1) The economic stockage principle.
- (2) The economic order principle.
- (3) The variable safety level principle.

The economic stockage principle governs the items which may be selected for storage. The economic order principle provides specific rules on how frequently and in what quantities stock should be replenished. The variable safety level principle governs the determination of safety levels based on operating level factor, the number of demands, item essentially, and the order and shipping time for the item.

9-27. Inventory Management Overseas

a. The problems of oversea inventory management are more demanding than those consolidated property offices or the Army stock control centers in the United States. The distances from the source of supply create the primary problem, but coupled with this is the urgency often associated with supply decisions overseas. In combat zones, the reason for urgency is obvious, but even in theaters where there is no immediate conflict, there is still a need to maintain materiel as ready for combat as possible. However, the basic tech-

niques of inventory management are not complicated. The operating level, safety level, and war reserves for each theater, usually expressed in terms of days of supply, are established by HQDA. Also, an average order and shipping time can be calculated. Inventory managers, then, are concerned primarily with quantifying the day of supply for each item; i.e., establishing the average number of each item which will be issued per day. To do this, inventory managers calculate an average demand over the previous 12 months.

b. The requisitioning objective which represents the maximum stockage authorized to be on hand and on order, is expressed in typical days of supply. The requisitioning objective consists of the sum of the operating level, safety level, and order and shipping time. As soon as the stock record for an item indicates the quantity on hand and on order is equal to the quantified sum (days of supply converted to number of items) of the safety level and order and shipping time (reorder point), a replenishment requisition is placed. When heavy demands or protracted order and shipping times draw stock below the reorder point before an order can be placed, emergency action such as air shipment will often be necessary.

9-28. Inventory Property Accountability

a. The Inventory Control Effectiveness (ICE) Program, directed by AR 740-26, provides for maintaining inventory/property accountability over wholesale assets managed or owned by the Army. The program includes the following parts:

(1) *Inventory of materiel.* Inventories of wholesale and retail assets co-mingled under AMC materiel readiness/commodity commands, depots, arsenals and ammunition plants are conducted based on an Order of Merit List (OML). The OML sequences the items in priority demand sequence. Items with the highest demand are inventoried first.

(2) *Inventory research and reconciliation.* Following inventory, the balance on the depot file is submitted to the materiel readiness/commodity command. If the balances agree, the date of last inventory is updated. If the balances do not agree, the discrepancy is researched and the accountable record properly updated.

(3) *Audit match.* Depot and materiel readiness/commodity command records are compared quarterly. Both catalog data and quantities are compared. Those which quantitatively mismatch are researched for resolution. If this does not resolve the problem, the item is inventoried. Catalog errors are also researched and corrected.

(4) *Location survey.* A location survey is performed continuously throughout the fiscal year at the depots, each item being surveyed at least annually. This consists of a comparison of identification data (e.g., NSN, U/I, location, etc.) on an item with the data recorded for it on the file.

(5) *Quality control.* Quality control (e.g., counts, adjustments, research, receipts) is performed on various functions of the inventory system, both at the materiel readiness/commodity commands and at the depots.

b. The purpose of the ICE program is to maintain accurate accountability of Army stocks. All of the functions identified above are aimed at this.

9-29. References

a. *Army Regulations (AR).*

- (C)11-11 Army Programs-War Reserve (U)
- 11-12 Logistics Priorities Account/Code Structure (Fiscal Code)
- 700-120 Materiel Distribution Management for Major Items
- 708-1 Cataloging and Supply Management Data
- 710-1 Centralized Inventory Management of the Army Supply System

- 710-2 Supply Policy Below the Wholesale Level.
- 710-3 Asset and Transaction Reporting System
- 725-50 Requisitioning, Receipt, and Issue System
- 740-26 Physical Inventory Control
- b. *Field Manuals (FM).*
- 710-27 Logistics Inventory Management
- c. *Supply Bulletins (SB).*
- 700-20 Army Adopted/Other Items Selected for Authorization/List of Reportable Items
- d. *DA Pamphlets (DA PAM).*
- 700-1 Supply Management Reference Book
- e. *DOD Manuals.*
- 4130.2-M Federal Catalog System Policy Manual
- 4140.26-M Defense Integrated Materiel Management Manual for Vol. 1 Consumable Items: Vol. 1: Commodity-Oriented Items
- 4140.25-M Defense Integrated Materiel Management Manual for Vol. 2 Consumable Items: Vol. 2: Weapon System-Oriented Items

Chapter 10 DISTRIBUTION MANAGEMENT

Section I. OBJECTIVES AND CONCEPTS

10-1. General

a. Physical distribution is the movement of materiel from the point of production (manufacturer or vendor) to the point of consumption (consumer/customer). It is identified as the subfunction of supply which deals with the handling and processing of materiel from acquisition to delivery to the ultimate consumer — or elimination from the system. This subfunction includes the capability to identify, classify, receive, document, store, secure, maintain in storage, care and preserve, select, pack, package, ship, control intransit, and dispose of materiel.

b. To better describe the complexity of physical distribution, the performance requirements placed on this function must be identified. Within the Department of Defense (DOD), materiel is received from a magnitude of different sources. This materiel is stored in hundreds of different locations. Much of it must be worked into a usable configuration prior to issue. It must all reach the customer in serviceable condition. It must be delivered when and where it is needed to forces worldwide. The system design must be one which is flexible to change, cost-effective, as well as responsive to the needs of its customers. The system must be able to deal with all types of commodities, many requiring special handling; e.g., hazardous and sensitive materiel or items of different sizes, shapes, weights, and configurations. It must also be able to move materiel from the users such as customer returns which pose special problems in addition to unforecasted workloads upon the system.

c. To better portray the concept of total Army distribution system, some basic facts about production and consumption are offered:

- (1) Raw materials are seldom processed where they are found.
- (2) Separate parts or components are often assembled into end items at places other than where they are made.
- (3) A number of the items stored are often inactive or slow movers during peacetime.
- (4) Consumption rates are often erratic and seldom, if ever, match rates of production.

10-2. Distribution Objective

a. The primary objective of this function is to provide an effective and efficient means to distribute materiel in support of U.S. Army operational readiness requirements in peacetime and under mobilization/

wartime conditions. Within this objective, the function must provide the appropriate response to user requirements without disruption, and within reasonable costs.

b. To accomplish this objective, the distribution function must operate to receive materiel from commercial or U.S. Government production facilities, commercial supply sources, other U.S. military services and Government agencies, and foreign sources. It must be able to store materiel in facilities in the Continental United States (CONUS), in oversea theaters, at off-shore bases, and, if appropriate, at sea. It must provide the processing necessary to maintain supplies in storage, prepackag, preserve, and configure supplies for issue which will meet the normal and emergency requirements of the user. Procedures to control the flow of materiel in addition to the documentation and information required to manage the function are essential. Every effort is made to:

- (1) Minimize the administrative burden of the Army in the field.
- (2) Maximize throughput from source to user.
- (3) Utilize appropriate transport within reasonable cost limits as dictated by the issue priority and to reduce stockage levels required at the general support (GS)/direct support (DS)/user levels.
- (4) Unitize, containerize, and/or otherwise configure materiel in a manner to reduce handling requirements and support the throughput concept.

10-3. Basic Distribution Channels

a. There are three basic channels in the Army distribution system:

- (1) Manufacture to vendor to Army/Defense Logistics (DLA)/Agency General Services Administration (GSA)/other military service depot to installation GS storage activity to DS/user.
- (2) Manufacturer or vendor to installation/GS/DS activity to user.
- (3) Manufacturer/vendor to user.

b. There are several variations to these channels. Whatever the channel, the item manager is influenced by and influences the actions of other managers, such as those for transportation and inventory. The item manager is constantly aware of the costs involved in the amount of inventory stored and the location of storage activities in relation to the user. The item manager documentation for accounting and locating

materiel in storage. The handling requirements, break-bulk, and prepacking requirements are important processes of distribution. The item manager recognizes transportation costs can be reduced by shipping in large quantities. However, this works in conflict with the objective of keeping stockage levels as low as possible. To meet the requirements of responsiveness to the user, the stockage of a wide range and high levels of items is indicated. This increases the costs of storing, processing, and handling the materiel. Because of these conflicts, the item manager must work with the transportation manager and others to determine the trade-offs which can be made to make the system responsive, economical, effective, and efficient.

10-4. Systems Concept of Distribution

a. Through the use of the systems approach, the manager has a highly effective tool for solving complex distribution problems. By defining what the distribution system must accomplish and analyzing significant possible options, the manager can determine the best possible solution. While direct delivery from the vendor to the user would appear to be the optimum distribution system, it is not practicable. This is because of many constraints, such as war reserve (including project stocks) requirements for additional preservation or packaging, volume procurement practices, commodity peculiarity consumption factors and budgetary constraints.

b. The systems approach provides for a system manager to integrate all subfunctions and processes into a whole system. It makes it possible for the manager to make decisions with full knowledge of their impact on total costs. This approach makes it possible to put to profitable use new techniques and new technology.

10-5. Army Distribution Concepts

The Army distribution system is intended to be compatible with the environment in which it operates. It interfaces effectively with the logistics systems of the U.S. Navy, U.S. Air Force, Joint Forces, and other governmental agencies furnished logistics support by the U.S. Army or which support the Army. The distribution system is somewhat unique in that there are several concepts of operation within the system which have an impact on all of the basic functions of receive, issue, store, process, and ship. These operational concepts are discussed in the following paragraphs to provide an insight of them.

a. *Initial Preplanned Supply Support.* Preplanned supply is a method by which certain supply requirements are shipped or issued to deploying forces for a predetermined period of time based on planned, prepositioned requests. The primary objective of this method of supply is to provide adequate support to

combat troops under conditions of rapid change in which normal supply procedures do not provide timely, effective, and efficient support. To be effective, preplanned supply must be included in the logistics support plans designed to support the various contingency plans.

b. *Planned resupply.*

(1) Planned resupply is an in-CONUS determination of the requirements of using organizations within the theater of operations for authorized stockage items. The objectives of this method of supply are to relieve the combat commander of the administrative burden of requisitioning supplies; and to provide the wholesale logistics system with a capability to replenish theater stocks on a systematic basis. These items of supply are the shipped to the theater when called forward by the theater Army commander.

(2) To be an effective operating system, planned resupply is dependent upon forecast of consumption requirements or valid replacement factors upon which quantities for routine shipment can be based. It is essential that the logistics system address itself to the collection of these factors. Lacking such factors, the logistics system depends upon the visibility it has of theater stock status and transactions to schedule replenishment. This is based upon drawdown of theater stocks and keyed to past and forecast levels of operation of the supported forces.

c. *Throughput of supplies.* This is the term used to describe shipments which bypass one or more intermediate supply echelons in the supply system, thereby avoiding multiple handling. This method of supply enhances the objectives for: reduction of materiel in the pipeline; reduction of depot stockage levels; reduced response time to user requirements; reduced handling, storage, and transportation costs; and reduction in facility requirements. Throughput of supply reduces the costly and time-consuming process of storage of materiel and the rehandling effort involved in handling shipments in depots and terminals on a piece-by-piece basis. An example of such a system is the Direct Support System (DDS).

d. *Unitization of shipments.* Shipments are unitized to consolidate, into a single load, quantities of one or many different line items of supply in such a manner that the load can be moved in an unbroken state from a source as far forward as practicable to distributor or user. The principal trend in unitization is toward maximum use of intermodal containers. The C5A aircraft in the U.S. Air Force inventory, and commercial aircraft such as the 747, provide a significant number of aircraft in operation capable of transporting large tonnages of unitized cargo. Commercial rail, highway, and ocean carriers have attained a container capability of considerable magnitude with a compatibility for intermodal shipments.

(1) By configuring cargo in unitized loads to the maximum extent possible, the requirement to delay materiel at intermediate points for sorting and reunitization is reduced. This can be used to reduce costly oversea base development and other facility type requirements.

(2) Unitization in whatever form practiced, must consider the user. Unitized loads must be so configured that they do not exceed the capability of the cosignee to handle them. This holds true until the point where bulk must be broken and supplies may have to be handled manually.

e. Pre-positioning of supplies and equipment. Pre-positioning of materiel will be required as long as the transportation capability is inadequate to support rapid deployment. Support of pre-positioning concepts entails the capability to redistribute a considerable volume of materiel to initially stock the facilities. In addition a requirement to change stockage to meet equipment requirements is dictated by changes in force structure and to replace stocks which have become obsolete. All pre-positioned stocks are configured for support of a tailored force structure. In addition to providing tables of organization and equipment (TOE) and other materiel to support a force structure, amphibians, barges, and helicopters may have to be pre-positioned to accomplish off-loading operations over the beach.

f. Prepackaging modules of supply. This concept is used in support of rapidly deploying forces and to reduce the logistics efforts of support forces. This is done through prepackaging supplies in a manner which will satisfy supported unit needs for various commodities over a given period of time. The concept is based upon consumption of items of supply which are classified into two basic type categories of consumption. One category is keyed to the number of troops consuming an item, such as rations. The other category is keyed to the number of end items or pieces of equipment which consume items (such as repair parts). Factors for both categories are based on level of support to be provided. Based on consumption factors, items which are consumed can be packaged in quantities, or modules of supply to support specific units for a given period of time. The concept complements a preplanned supply system and reduces the handling of individual items of supply.

g. Total Package Fielding. The U.S. Army Materiel Command (AMC) has developed an improved materiel fielding process—Total Package Fielding (TPF).

(1) AMC will implement TPF for all its materiel system fielding unless specifically exempted. TPF is the Army's standard fielding method.

(2) Under TPF the materiel fielder assumes additional responsibilities to relieve the gaining MACOMs and their subordinate units of much of the logistic burden previously associated with the materiel fielding process. The materiel fielder develops, plans, and procures the materiel system.

(3) In addition, the materiel fielder—

(a) Requisitions the system and all its support with the exception of class III, V, and VIII items.

(b) Coordinates the Materiel Requirements List (MRL) with the gaining MACOM.

(c) Consolidates and packages support by unit level.

(d) Delivers, performs a joint inventory at handoff, and provides documentation for all materiel to be posted to unit records.

(4) Total packaging will contain different levels of effort for both the fielding and gaining commands based on the category of total packaging fielding.

(5) Three factors are consistent throughout all categories.

(a) First, the fielding command will program funding for initial issues materiel to be provided under total package fielding.

(b) Second, the fielding command will requisition the initial issue materiel except for class III, V and VIII items.

(c) Third, the fielding command will provide the customer documentation to establish accountability and requisitioning objectives (RO).

(6) TPF includes concurrent handoff of the primary materiel system and its support package which includes—

(a) The primary system including all component major items and associated Basic Issue Items (BII).

(b) Associated support items of equipment (ASIOE) and associated BII.

(c) Special tools and test equipment (STTE).

(d) TMDE including ATE and test program sets (TPS) and interconnecting devices.

(e) Organizational support equipment when called for.

(f) Technical manuals.

(g) PLL/ASL.

10-6. The Materiel Distribution Pipeline

a. The administrative and physical structure through which demands for materiel are expressed and goods flow to the point of ultimate use is known as the distribution pipeline. The pipeline is both physical (with storage locations and transportation facilities) and administrative (requiring pro-

cessing of documents). The physical structure of the pipeline makes possible the flow of materiel through the military distribution system from the point of receipt to the point of final use.

b. Some provision for storage is necessary to ensure dependable supply. Along the distribution pipeline, between the source and the user, there

must be reservoirs of materiel to maintain a balance between the erratic rates of consumption and the more predictable rates of production. These reservoirs (depots, stockage points, etc.) and carriers (ships, barges, trains, motor vehicles, planes, or oil pipelines) constitute the logistics pipeline.

Section II. STORAGE

10-7. Storage

a. Storage provides time utility to materiel to ensure the capability of response to satisfy consumer requirements. It is the instrument by which the fluctuating rate of consumption of supplies is kept in balance with the more uniform rate of production. Storage facilities are strategically located to support rapid deployment and normal resupply operations; to minimize the effect of surges in demand and interdiction to the lines of communications; and to smooth the flow of supplies from producer to consumer. The effectiveness of the storage operation is reflected by its ability to fill requirements; ship materiel on time against materiel release orders; and by its efficient utilization of storage space.

b. To be effective, the Army storage function must meet several performance requirements.

(1) It must be constituted to support Army supply operations in peace and war on a worldwide basis as required.

(2) Storage facilities must be adequate to support the total Army and be capable of expansion under mobilization conditions.

(3) Storage facilities must be readily accessible to one or more forms of common carrier (rail, highway) and be capable of rapidly and accurately handling receipts and issues.

(4) It must provide for the care, preservation, and maintenance of materiel in storage.

(5) Other considerations include physical security from theft, sabotage, overt enemy attacks; protection from fire and natural disasters; and contamination by chemical, biological, and radiological elements.

c. There are two general classifications of storage space—covered and open.

(1) Covered storage space is storage space within any roofed structure.

(2) Improved open storage space is an open area which has been graded or hardsurfaced, and drained to permit use of materials handling equipment.

d. Storage layout plans are developed in accordance with DOD policies for uniformity and standardization. Items are stored by Federal supply class with location based on size, activity, and turn over.

e. Most items of general supply do not require special handling or storage methods. Others require special handling. For instance, some materials are handled in bulk; hard fuels require special storage areas and handling equipment; and liquids handled in bulk require pumps, pipelines, and special storage tanks. Consideration is given to the special handling and storage of all such materials in planning the storage areas. When the materials have a limited storage life, care must be taken to ensure the oldest stock is issued first. Many items with high resale value are subject to pilferage, thus requiring controlled security measures.

f. The rapid selection of stocks for shipment, efficient handling of receipts, and the maximum use of storage space depend upon the effective use of an adequate stock locator system. The basic element of a good locator system is the record for each stock item. Stock locator records contain the stock number, the unit of issue, nomenclature, and location of the lot for each item stocked. Periodic location surveys verify recorded locations against actual locations. Also, stock locations are verified at the time normal stock inventories are taken as a part of the regular inventory procedure. Maximum use of storage space takes precedence over the minimizing of the number of locations. This is accomplished through the use of location records for selecting items for shipment.

g. The care of supplies in storage (COSIS) (AR 740-3) program is designed to perform the task of ensuring that the true condition of supplies in storage is known, that the condition is properly recorded, and that the supplies are provided adequate protection while in storage. COSIS is concerned with in-storage inspection, minor repairs, testing, preservation, and packing of stored supplies.

10-8. Packaging of Materiel (see AR 746-1)

All supplies, materiel, and equipment entering or in the DOD supply system, including movement in

or between oversea theaters, must be afforded the degree of preservation, packaging, and packing required to prevent deterioration and damage during shipment, handling, and storage.

Section III. DISTRIBUTION OF ALL CLASSES OF SUPPLY

10-9. Materiel Distribution

a. As previously stated, the distribution system moves materiel from the producer to the consumer as expeditiously as possible. The ideal system would be on a throughput basis from a producer to the ultimate consumer. This system would eliminate all intermediate distribution echelons, thereby, saving valuable resources for application elsewhere in the military system. However, sophisticated systems have not yet been developed to accurately forecast such factors as requirements, supply rates, production rates, raw material availability, and customer locations. This requires that stock piles of supplies be established at intermediate points to overcome these deficiencies in the system and to store reserves for contingencies. At each point where supplies are stored, there is a requirement for expenditure of resources. To minimize resource expenditure, it is necessary to maximize the throughput of supplies. This was the basic premise for the development of the DSS and the airline of communication (ALOC). The distribution of bulk petroleum products is an example of providing supplies directly from the manufacturer to the user. The need for bulk petroleum storage in CONUS is insignificant.

b. For most other supplies, there is a need to establish depots to compensate for deficiencies in the system and the storage of reserves. Nevertheless, whenever feasible, supplies are shipped directly from the producer or vendor to the requisitioner.

10-10. Distribution of General Supplies.

a. General supplies are categorized as classes II, III (packaged), IV, selected V (missile systems components only), selected VII, IX, and maps. Except for items authorized for local or offshore procurement, general supplies are centrally procured and stored in depots. Items which have been coded for central management by DLA and GSA are procured by those agencies and stored in depot space allocated to those agencies. Army-managed items are procured and stored in allocated space in CONUS Army depots. Army installations in the United States requisition these centrally managed

supplies from the appropriate inventory control point (ICP) for delivery from the depot directly to using units or installation storage points. When possible, general supplies are shipped from the wholesale CONUS depot system to the requisitioner.

10-11. Distribution of Class I Supplies—Subsistence

a. The Defense Personnel Support Center (DPSC) of DLA procures food for the Armed Forces centrally from DPSC headquarters and through regional headquarters and permanent or seasonally operated field buying offices. The headquarters buys nonperishable and certain perishable requirements from among CONUS suppliers. Delivery is made to either CONUS depots for consolidation or shipped direct to the requisitioner. Each region operates storage and distribution facilities for perishable and nonperishable foods. Each region may procure nonperishable subsistence for delivery to depots or installations.

b. Class I supplies will be provided on a "push basis" (based on troop strengths) at the initial buildup. As soon as possible, requisitions should be based on actual consumption data. Strength data are provided by the personnel services center of the installation or unit.

c. In CONUS, class I supplies are shipped from designated DLA distribution points or regional marketing centers to the installation subsistence storage facilities for redistribution to ration distribution activities, troop issue subsistence activities and resale commissaries. Some subsistence items are procured locally and must be inspected by a veterinary activity for quality wholesomeness and potential health hazards.

d. In theaters of operations, Class I shipments to troop units are generally throughput to DSUs, if feasible and conditions permit. GSUs may otherwise have to be used to receive, store, and issue as required. The DLA operates a direct supply support system to commissaries. Perishable subsistence procured locally must also be inspected by the veterinary service. DLA function in a European war theater is the subject of Memorandums of Understanding between U.S. Army, Europe (USAREUR) and DLA.

10-12. Distribution of Class III Supplies—Bulk Petroleum Products

a. Class III supplies include bulk petroleum products, package petroleum products, liquid and compressed gases, bulk chemical products, coolants, antifreeze compounds, and coal. This paragraph describes the distribution of bulk petroleum only, because the distribution of package petroleum follows patterns described for general supplies. Bulk petroleum products highly critical to military operations are distributed by means of unique carriers and systems, and are subject to distinctive controls.

b. Requirements for Army activities are forecasted annually by users to the U.S. Army General Material and Petroleum Activity (USGMPA), under the Troop Support Command, an agency of the Army Materiel Command (AMC). After review, those requirements are forwarded to the Defense Fuel Supply Center (DFSC), a major subordinate command of the Defense Logistics Agency (DLA), for acquisition. These requirements are combined with those of other services. They are solicited on a competitive basis as a part of one of the Center's major procurement programs (Atlantic/European/Mediterranean, Pacific, Eastern CONUS, or Western CONUS). Contracts are awarded based on the lowest cost of transporting it from the providing contractor to the user.

c. Almost all distribution in CONUS is done by DFSC using commercial concerns. However, overseas the Army is charged with the mission of the storage and distribution of petroleum to all DOD components (except Navy ocean terminals). Army management of petroleum is centralized under the Theater Army commander. Requests for fuel are received from customers. Deliveries are then scheduled from the appropriate terminal or contractor by the most efficient transportation method using either Army or contract transportation, as appropriate. For undeveloped theaters the Army has developed a complete system of tactical equipment for fuel storage and movement. This Inland Petroleum Distribution System consists of a coupled pipeline, pump stations, bladder storage and associated components. Normally, pipeline is the preferred method of movement due to its efficiencies, economies, and security advantages. However, if shipment by pipeline is not feasible an alternative method is used. These methods are as follows: barge, tank truck, railroad tank car, bladder bird (fixed wing) or helicopter, or movement by drums or cans. Scheduling of product into Army-managed Ocean Terminals is done by the unified command Joint Petroleum Office (JPO). Resupply

requirements are developed by the Army component commander's management office and forwarded to the JPO. The JPO consolidates these with other service component requirements and submits them to DFSC. The Defense Fuel Supply Center then schedules fuel to be picked up from fuel suppliers on Military Sealift Command ships.

d. A significant process in the distribution of Class III products is quality assurance/quality surveillance. Quality assurance is normally performed by DFSC Quality Assurance representatives at the point of acceptance from a contractor. It is required to ensure the fuel meets required specifications. Quality surveillance is performed by Army personnel after fuel is accepted to ensure required specifications are maintained. Quality surveillance facilities include base and mobile petroleum laboratories and petroleum test kits.

e. The theater petroleum supply system begins with receipt in the theater of bulk petroleum products. These are received in the theater from ocean tankers which may discharge to tactical petroleum terminals, and the inland petroleum distribution system. Generally, pipelines are used to move bulk petroleum products from storage at the terminal to intermediate storage terminals or direct to the user. The ideal transportation method is by pipelines. To maintain a continuous flow in pipelines and to allow for surges in demand, intermediate storage tanks are required.

10-13. Distribution of Class V Supplies—Ammunition

a. The distribution of SMCA-managed ammunition is of special significance because of both the tonnages involved and the technical problems of segregation, identification, storage, and protection. The ammunition supply system includes both the supply and maintenance of conventional and special ammunition.

b. Special ammunition items are those which require extraordinary control, handling, and security. Special ammunition includes nuclear warhead sections, atomic demolition munitions, nuclear projectiles, missiles, and certain lethal and toxic chemical munitions. Conventional ammunition includes all other ammunition items.

c. Certain aspects of planning for the supply of ammunition are particularly significant to the distribution process. In peacetime, ammunition is stored as mobilization and contingency reserves. It is also stored in limited quantities for training. Storage of reserves is particularly important because of the potential of degradation and obsolescence. Three key considerations of storage planning are storage by production lot, instorage

maintenance, and modification of rounds to prevent obsolescence. In addition, at the ammunition supply point (ASP)/depot level, lot size, quantity, and compatibility assume significance.

d. Conventional ammunition requirements are stated in terms of basic load, the rate of supply required to support a planned tactical operation, and the ammunition which can be made available to support the operation. These are expressed as rounds per weapon per day for ammunition fired by weapons and other units of measure for bulk allotment items. Requirements for ammunition service in a theater of operations originate with the planned deployment of tactical forces for actual or anticipated combat. Basic loads to accompany the tactical force are prescribed by the Army component commander and are issued prior to entry into the combat arena. Replenishment stocks are positioned in supply points in accordance with stockage objectives established by Headquarters, Department of the Army (HQDA). The storage objective is the maximum quantity of ammunition to be maintained on hand to sustain current operations. Based on the theater stockage objective, the theater materiel management center establishes a requisitioning objective for each item of ammunition. Combat zone (CZ) requirements for ammunition are forecast by the determination of a required supply rate (RSR). The RSR is an estimate of the amount of ammunition required to sustain combat operations for a specified time without restrictions. It is normally expressed in rounds per weapon per day. A controlled supply rate (CSR) may be imposed by a commander when there is a restriction or shortage of ammunition supply.

e. Conventional ammunition service in the field is based on a continuous refill system. Tactical

units are responsible for maintaining a basic load of ammunition. As this ammunition is expended, it is replaced by drawing ammunition from an ASP or, in the case of high density, fast-moving munitions, an ammunition transfer point (ATP). This is affected by the presentation of transportation orders authenticated by the division ammunition officer or a designated officer. The purpose of authentication is to provide a means for the tactical commander to control ammunition issues. Withdrawals from ASPs or ATPs are replenished by shipments from the communications zone (COMMZ) or CZ stockage points. Training ammunition is controlled by a system of credits; by a system of rationing; and by restrictions in firing. Ammunition is moved forward into the combat zone as directed, or on request or call from the corps, from the COMMZ storage areas. Adequate stocks must be placed in these storage points to meet these credits, and established stock levels must be maintained to ensure an uninterrupted supply of ammunition to combat troops.

f. Special ammunition is allocated in command channels to the tactical commander employing the weapons. Upon receipt of a materiel release order (MRO), shipping instructions, or other authority directing a shipment, the special ammunition stockage point should plan the mechanics of the specific shipment. Ammunition to be shipped must be verified for availability, quantity and quality. Positive identification is required for the unit representative to receive the shipment. The availability and authority of the receiving unit to draw the items must be verified. Materials handling equipment, safety equipment, tools, materials, and supplies required to brace, store, palletize, and secure

items of a shipment during transit must be assembled. Every individual involved in the shipment of special ammunition is responsible for complying with rules and regulations governing its safe transportation. Proper transportation of special ammunition is of utmost importance due to the criticality and sensitivity of the materiel. Movement planning must provide for emergency destruction of nuclear weapons and nuclear weapons materiel (if authorized) while items are in transit.

g. Proper distribution planning is necessary to ensure sufficient ammunition is on hand to permit replenishment of each day's expenditure and to minimize delay in meeting approved demands. Adequate planning considers the proper balance among requirements, storage, and transportation facilities and their efficient use. It provides for security, flexibility, and mobility of the system. Alternate channels for service and supply are also provided. Major emphasis is placed on sustaining a flow of supplies rather than the buildup of stocks.

10-14. Distribution of Class VI Supplies—Personal Support/Exchange Items

Distribution of personal demand items (e.g., cameras, watches) in CONUS is managed outside the logistics system using nonappropriated funds. Distribution overseas, however, involves the Army and Air Force exchange distribution system. Personal demand items are usually controlled separately within major overseas depots and distributed to sales points (e.g., post exchange) directly from the distribution centers. Distribution of personal demand type items (toothpaste, razors, etc.) to troops during wartime is made in the form of sundry packs and is provided in conjunction with the distribution of Class I.

10-15. Distribution of Class VII Supplies—Major End Items of Equipment Authorized in Allowance Tables

A significant difference exists between distribution of major end items and secondary items. Major end items are regulated items and are controlled and distributed in accordance with carefully developed distribution plans (TAEDP) based on authorization documents (MTOES) and unit priorities (DAMPL). Additional selected major end items may be authorized for stockage as maintenance float for replacement of like items of equipment evacuated from using activities either for the performance of maintenance operations which cannot be ac-

complished in a timely manner or for scheduled depot maintenance. The physical distribution of major end items both in CONUS and overseas is usually through the DSS. Secondary Class VIII items that are not command controlled are requisitioned through the normal procedures.

10-16. Distribution of Class VIII Supplies—Medical Materiel and Repair Parts

a. The DPSC procures and manages medical, dental, and veterinary supplies and equipment which are common to the three military departments. In CONUS, deliveries of medical materiel are made directly from DLA depots to medical units, usually hospitals, located at CONUS installations. In overseas areas, medical materiel is shipped via Medical Airlines of Communication (MEDLOC) to: the United States Army Medical Materiel Center Europe (USAMMCE); to installation medical supply activities; and to Medical Supply, Optical, and Maintenance (MEDSOM) battalions for further distribution to medical units.

b. The medical supply system operates within the framework of the Army logistics system. Medical logistics policies and procedures are tailored to the unique requirements of the medical mission. These differences exist because of the criticality of the Army medical mission, the catastrophic effects of medical materiel shortages, and the fact that medical supplies are used almost exclusively by professional personnel of the Army Medical Department.

10-17. Distribution of Class X Supplies—Nonmilitary Support Materiel

Class X supplies are also regulated and their issue must be approved by the appropriate commander. The distribution of class X supplies to support nonmilitary programs (e.g., agricultural and economic development) depends on agreements with the foreign countries supported and with elements of the other departments of the Government (primarily the State Department). Usually, delivery of these items follows the same channels as general supplies for the Army except they are normally distributed to the foreign government directly from a terminal or major overseas depot. The significance of class X supplies is they use resources which would otherwise be available for the distribution of Army requirements. Nevertheless, the supply of these items may be important enough to take precedence over some of the less essential Army items, provided critical operations are not impaired.

Section IV. THE DIRECT SUPPORT SYSTEM (DSS)/AIRLINE OF COMMUNICATION (ALOC)

10-18. Introduction

a. The DSS is the Army standard supply distribution system for selected classes of supply. The DSS expedites the movement of supplies from the CONUS wholesale base directly to the consignee (e.g., supply support activity (SSA)), bypassing the intermediate overseas activities or the CONUS installation supply divisions (ISD).

b. The DSS has resulted in major improvements to the supply distribution system by providing:

(1) Visibility of the supply and transportation pipeline.

(2) A physical distribution system that maximizes containerization techniques.

(3) National distribution of stocks positioned at designated area-oriented depots (AOD) to best support geographically oriented customers.

(4) Improved customer support by reducing order ship time (OST).

(5) The reduction of intermediate level operating stocks.

c. Stockage at the overseas activities is limited to war reserve and project stocks or an essentiality based safety level for those items not included in the reserve or project stocks which qualify for storage under the general support sustaining base (GSSB) concept. The essentiality based safety level or war reserve and project stocks provide a surge tank to meet issue priority designators (PD) 01-03 and "not mission capable supply (NMCS)," or to accommodate pipeline interruptions caused by acts of God, labor disputes, or interdiction in time of war. In CONUS, the ISD stockage is limited to contingency stocks and those required to support non-DSS customers satellite on the installation.

d. The ALOC is a refinement of the DSS and is designed to streamline DSS procedures by routinely shipping all priorities of class IX repair parts (with in weight and cube limitations), medical material and maintenance related class II by air to designated units. The ALOC goals are to—

(1) Improve the responsiveness of repair parts support from CONUS by reducing OST to 23 days for USAREUR, 28 days for Korea, 29 days for Japan, 26 days for Alaska and 25 days for Hawaii.

(2) Reduce repair parts inventories, both in the supply pipeline and on hand in USAREUR, Korea, Alaska, Japan and Hawaii.

(3) Permit a rapid return of excess and reparable items to CONUS.

(4) Improve combat readiness in USAREUR, Korea, Alaska, and Hawaii. (Class VII items are also

distributed to Korea and Europe through the ALCO).

e. An integral part of the system is a logistics intelligence file (LIF) which provides intransit visibility of pipeline assets. The LIF effectively integrates supply and transportation documentation to provide logistics managers an independent source of performance data and a complete overview of the total logistics pipeline. This integrated technique permits managers to identify precisely problem areas and to determine the most effective methods to support the Army in the field. (see paragraph 12-5d)

10-19. Operations

a. DSS procedures apply to the following classes of supply:

(1) II (secondary items of individual clothing, equipment, etc.).

(2) III (packaged petroleum only).

(3) IV (construction equipment).

(4) V (missile components only).

(5) VII (major end items).

(6) IX (repair parts).

b. There are three AODs specifically designed to support a geographical area.

(1) New Cumberland Army Depot (NCAD): Europe, Eastern CONUS, and Panama/Southern Command.

(2) Sharpe Army Depot (SHAD): Pacific and Western CONUS.

(3) Red River Army Depot (RRAD): Central/Southern CONUS.

This arrangement facilitates distribution of stock based on actual demands as accumulated under the requisition activity address code. Materiel stored and stockage levels maintained at the AODs are managed by the national level item manager. The method for determining the range of items and the stockage quantities for the distribution depots is based on customer demands.

c. CONUS requisitions flow from the Supply Support Activity to the Installation Supply Division for editing the validity of supply data, funding, and fill in accordance with prescribed fill/pass logic. The requisitions are then transceiver to the Defense Automatic Addressing System (DAAS) for routing to supply source and providing images to the LIF for gathering of logistics intelligence information and to the MILSTEP File for wholesale pipeline performance evaluation. Upon arriving at the activity managing the item (Army, GSA, DLA, ICP), release is directed from a depot or depots. The materiel release orders (MRO) are passed

through the DAAS where image copies of all transactions again go to the LIF and the MILSTEP. Shipments to CONUS customers from the Army, DLA or GSA distribution depots are forwarded to the installation central receiving point (CRP). The depot returns a materiel release confirmation through the DAAS to the controlling national inventory control point (NICP). The CRP receives all shipments of DSS materiel from commercial sources (vendors), parcel post, mixed cargo shipments of DSS and non-DSS materiel and mixed cargo shipments for DSS participating and nonparticipating units. In those cases where all of the supplies on a particular transport mode are for one or a few customers, delivery is made directly to the customer after being checked through the CRP.

d. Oversea requisitions flow from the Supply Support Activity to the incountry materiel management center (MMC) for editing the validity of supply data, funding, and lateral supply. Requisitions will flow in the manner explained in the preceding paragraph for CONUS requisitions. Materiel destined for oversea shipment is consolidated into containers or Air Force cargo pallet loads at the consolidation and containerization point (CCP) located at the AOD. The containerized shipments bypass the bread-bulk points/oversea storage activities and move directly to DSUs/drop points whenever possible. Not all shipments will move directly to DSU (or SSA) drop points. Not all have sufficient volume for economical utilization of direct container shipments. To provide the benefits of DSS to these units and attain maximum through-container service, logistics support plans are designed to take advantage of clustering units for delivery service. Full container loads may continue to be shipped to single

consignees; however, to achieve full container utilization, sequential loading or drop-point loading of a single container for delivery to multiple consignees will be used. The integrity of each supply support activity shipment and associated documentation is maintained in the containerized shipments. The container is delivered in accordance with the incountry DSS distribution plan. High-priority items (PD 01-03) for air shipments are loaded on pallets and forwarded to a single SSA or drop point. A more complete explanation of DSS can be obtained from FM 38-725.

e. The flow of requisition and materiel under ALOC is basically the same as under DSS. Like DSS cargo, ALOC cargo is consolidated at the AOD CCP. ALOC cargo is loaded on to the Air Force cargo pallets and moved by commercial truck to an aerial port of embarkation (APOE). From the APOE, the cargo is moved by Military Airlift Command (MAC) aircraft to the oversea aerial port of debarkation (APOD). From the APOD, the cargo is moved by surface transportation to the consignee. Eighty percent of ALOC pallets moves to a single consignee. Pallets for more than one consignee are broken down at the APOD and moved loose to consignees. This system is designed to operate on a 7-day week delivery cycle for Europe and Korea and a 5-day week cycle for Alaska, and Hawaii.

f. The increased use of airlift to these ALOC areas will result in an increased allocation of airspace-available transportation for retrograde cargo to CONUS. Priority on the use of retrograde air is to be given repairable items being returned to CONUS for overhaul/repair. Second priority is to be given excess repairable being returned to CONUS stock.

Section V. THE MILITARY STANDARD LOGISTICS SYSTEMS

10-20. Introduction

The ever-expanding use of automatic data processing equipment (ADPE) and digital communications networks requires a common language of machine-sensible codes and formats. Such a common language must be recognizable not only to the machine and communications equipment but also to the human operator. Standardization and integration of data systems permit the output of one data system to be communicated and used as the input to other related data systems. A prime example of this standardization and integration of data systems is to be found in the Military Standard Logistics Systems (MILS). Each of these standard systems was designed to standardize and automate the paper processes concerned with its area of responsibility, e.g., requisitioning and issue of supplies, accounting for inventory, transportation and movement of inventory, performance reporting of sup-

ply and transportation phases and others. As the need for increased communication continues and as new systems are developed, new languages will be required and new MILS will be established.

a. The Military Standard Requisitioning and Issue Procedures (MILSTRIP) was the first of the MILS and led to the growth of the remaining standard logistics systems. MILSTRIP prescribes uniform procedures for requisitioning and issue of materiel between requisitioners and supply control/distribution systems and utilizes standard single-line item format documentation. Some documents which can be produced by manipulating reading data to the cards are requisitions, cancellations, passing orders, referral orders, supply status, followup, followup answers, MROs, shipment status, materiel release confirmation, ma-

teriel release denials (MRD), notice of availability, requisition modifiers, and reconciliation requests. The implementing publication is AR 725-50.

b. The Military Supply Transaction Reporting and Accounting Procedures (MILSTRAP) prescribes and standardizes machine-sensible codes, formats, uniform procedures, and time standards for recording inventory management data passed between elements of a single distribution system or transmitted between various DOD distribution systems; e.g., inventory control and stock control activities, depot storage sites and post, camp, base, or station. MILSTRAP documentation is utilized to record demand data for establishing requirement levels, accounting for receipt and issue of DOD assets, performing inventories and processing of adjustments to accountable records, effecting logistics reassignments, and processing of special program requirements. MILSTRAP also provides for the small arms serial number registration and reporting between the DOD Central Registry and the Military Departments/DLA Component Registries. Exclusive of Special Program Requirements and small arms serial number registration, the implementing publication is AR 725-50.

c. The Military Standard Transportation and Movement Procedures (MILSTAMP) provides standard transportation movement procedures, codes, and formats which control the movement of cargo into and through all segments of the Defense Transportation System. In doing so, it interfaces with the supply procedures in MILSTRIP. MILSTAMP also prescribes the preparation of intransit data cards (IDC) at the shipping activity and their subsequent completion by the receiving activity, plus port receipt and lift data for export shipments. These data are essential to measure actual performance against transportation time segments prescribed in the Uniform Materiel Movement and Issue Priority System (UMMIPS) and to support the performance evaluation requirements of the Military Supply and Transportation Evaluation Procedures (MILSTEP). The implementing publication is DOD 4500.32-R.

d. MILSTEP is the system which evaluates the MILSTRIP supply requisitioning performance data and the MILSTAMP transportation performance data against the time standards of UMMIPS. These input data are mechanically manipulated to produce standard output reports by military department and by distribution system. These reports reflect, by issue priority, the elapsed time for requisition submission, supply source processing, cargo handling time, and intransit time by each segment of the transportation pipeline by point-to-point and carrier performance. MILSTEP also assists in the evaluation and maintenance

of UMMIPS time standards, as well as determining supply systems workload and materiel availability. The implementing publication is AR 725-50, chapter 13.

e. The Military Standard Contract Administration Procedures (MILSCAP) provides the standardized uniform procedures, record formats, data elements, and response times used in the interchange of automated contractual data between contract administration activities, buying offices, contractors, ICP, and other user activities. It is essentially a procedure to automate the various phases of contract administration to include contract abstracting, contract payment notification, shipment performance notification, destination acceptance reporting, plus other segments for future implementation into the 1980s. The implementing publication is DOD 4105.63-M.

f. The Military Standard Petroleum System (MILSPETS) has been established to provide automated standard procedures, forms, formats, data elements, codes, and methods for interservice/agency use relative to the management of petroleum products. Unlike the other MILS, MILSPETS is commodity rather than functionally oriented. To the maximum extent practical, standard data elements, codes, and formats of other MILS will be used in MILSPETS procedures. This includes the applicable provisions of UMMIPS. The implementing publication is DOD 4140.25-M.

g. The Military Standard Billing System (MILSBILLS) is the system which prescribes standard automated procedures and formats for billing and collecting for direct delivery from contractors, for reimbursable sales of DOD stock fund materiel, for appropriation financed materiel, and reimbursable sales from GSA. The implementing publication is AR 37-12.

h. DAAS is a real time, random access digital computer system linked to the automatic digital network (AUTODIN). Its basic purpose is to automatically route or pass supply transactions to the correct recipients. This system embodies the integration of logistics and telecommunications into a single data processing system. The DAAS is operated by the DAAS Office (DAASO) and has two automatic switching centers, one each at Dayton, OH and Defense Depot, Tracy, CA. Each is capable of full operation when the other is down. The system is in continuous operation 24 hours per day 7 days per week. The implementing publication is AR 725-50, chapter 14.

i. Uniform Materiel Movements and Issue Priority System (UMMIPS) is a system to ensure that requirements are processed in accordance with the mission of the requiring activity and the urgency of need, and to establish maximum uniform requisition processing and

materiel movement standards from and within the DOD distribution system. In itself, the UMMIPS is not a separate MILS. It is the DOD system which established common or uniform time standards and priorities, for use in those MILS such as MILSTRIP, MILSTRAP, MILSTAMP, MILSTEP, and MILSPETS. As a system, it establishes standards which permit the evaluation of each segment of the order ship time (OST). The overall objective of the UMMIPS time standards is to provide guidance in satisfying a customer's demand within the cumulative time prescribed for the assigned designator. It tells the customer within the urgency of need when he or she can expect to receive the requisitioned item. At the same time, it tells the supplying logistician how fast the response must be. An understanding of the MILS requires an understanding of UMMIPS, the "rule book" for all segments of the OST which are subject to time frame measurements or evaluation. UMMIPS is applicable to the requisitioning and issue processing of all items under the management of military departments, defense agencies, and, by agreement, GSA, for items in their depot program. The time standards prescribed cover interservice supply support operations for items normally stocked. Standards prescribed assume that the items required are in stock and available for issue; consequently, the standards do not reflect acquisition time. In the movement and issue of materiel, it is necessary to identify the relative importance of competing demands for the logistics system resources; e.g., transportation, warehousing, paperwork processing, and inventories. UMMIPS provides a ready basis for expressing the relative importance on requisitions and other materiel movement transactions through a series of two-digit codes known as issue priority designators. The issue priority designator ensures appropriate handling of competing demands. For more information pertaining to UMMIPS, see DOD Directive 4410.6 and AR 725-50.

10-21. References

a. Army Regulations (AR).

- 11-27 Army Energy Program
- 15-2 DA Allocation Committee, Ammunition (DAACA)
- 37-12 Interfund Billing, Collection and Reporting Procedures
- 37-100 Account/Code Structure
- 55-355 Military Traffic Management Regulation

- 190-11 Physical Security of Weapons, Ammunition, and Explosives
- 700-9 Policies of the Army Logistics System
- 700-15 Packaging of Materiel
- 700-120 Materiel Distribution Management for Major Items
- 703-1 Coal and Petroleum Products Supply and Management Activities
- 710-2 Supply Policy Below the Wholesale Level
- 725-50 Requisition, Receipt, and Issue System
- 740-1 Storage and Supply Activity Operations
- 740-3 Care of Supplies in Storage
- 740-26 Physical Inventory Control
- 746-1 Packaging of Army Materiel for Shipment and Storage

b. Field Manuals (FM).

- 8-10 Health Service Support in a Theater of Operations
- 8-15 Medical Support in Division, Separate Brigades, and the Armored Cavalry Regiment
- 8-21 Health Services Support in a Communications Zone
- 6-55 Planning for Health Service Support
- 9-6 Ammunition Service in the Theater of Operations
- 10-60 Subsistence Supply and Management in Theaters of Operations
- 10-67 Petroleum Supply in Theaters of Operations
- 38-704 U.S. Army Materiel Development and Readiness Command Logistic Control Activity and Its Role in Management of the Army's Supply Distribution Pipeline
- 38-725 Direct Support System (Management and Procedures)

c. Technical Manuals (TM).

- 743-200-2 Storage Modernization

d. DOD Regulations

- 400.25D DOD Activity Address Directory
- 4105.63m Military Standard Contract Administrations Procedures
- 4140.25M Procedures for Management of Petroleum Products
- 5105.38D Military Assistance Program Address Directory

PART FIVE: MAINTENANCE MANAGEMENT
CHAPTER 11
MAINTENANCE MANAGEMENT

Section I. INTRODUCTION

11-1. General

Maintenance is a major function in the life cycle of a system; as such, maintenance considerations are addressed in the initial concept phase and carried through the design, development, and fielding of a materiel/weapon system. As weapon systems become more complex and sophisticated, it becomes increasingly important that maintenance influence the design of the equipment to ensure simple, quick, effective maintenance tasks and techniques for sustaining that equipment in an operational readiness condition.

11-2. Army Materiel Maintenance Management Objective

The maintenance objective is established to provide the necessary policy and identify responsibilities to ensure:

- a. Army owned or supported materiel is sustained in a state of operational readiness consistent with the mission requirements of operating combat forces.
- b. Maintenance is accomplished at the optimum life-cycle cost.
- c. Reliability, availability, and maintainability (RAM) requirements are enforced during the equipment or system's entire life cycle.
- d. Reliability-centered maintenance (RCM) is used by maintainability and maintenance engineers to identify the minimum scheduled maintenance requirements needed to keep a system safe and reliable. Requirements are classed as hard time, oncondition, and condition monitoring. RCM will be applied as part of logistics support analysis (LSA) to all integrated logistics support (ILS) programs, for each level of maintenance.

11-3. Scope

a. Maintenance is defined as all actions taken to retain materiel in a serviceable condition, to restore it to serviceability, or to upgrade its functional utility through modification. It includes inspection, testing, servicing, classification as to serviceability, repair, overhaul, and reclamation.

b. Maintenance is a command responsibility at all levels of the Army. Effective maintenance support is vital to a sustained readiness posture. Specific policies regarding the maintenance of Army materiel are found in AR 750-1.

11-4. Army Maintenance Management Structure

a. Army maintenance is commodity/weapons system oriented. It is managed vertically between the various levels to enhance cost-effectiveness and responsive improvements. This vertical management relies on standard management information systems and accurate reporting to control fluctuations in maintenance workloads.

b. Army maintenance is managed by commodity groups, such as electronics, aircraft, armament, and missiles. The management effort within each group is influenced by an item's cost and essentiality. High cost, high demand, and high essentiality require more intensive management. Management by exception is practiced when deviations from the normal occur for any commodity.

c. The duties and responsibilities of specific organizations and agencies are listed in AR 750-1.

Section II. MAINTENANCE ENGINEERING

11-5. The Maintenance Engineering Doctrine

Maintenance engineering is the activity of materiel maintenance which develops concepts, criteria, and technique requirements during the materiel acquisition process. It is directed toward:

a. Influencing the design and development of materiel to ensure that adequate consideration is given to and provision made for its effective economic maintenance.

b. Designing and providing technical guidance for the acquisition, deployment, installation, and operation of the maintenance support structure for new or improved items entering the operational inventory.

c. Continuing analysis and evaluation of equipment performance data and maintenance data relating to operational equipment to determine need and prescribe changes in equipment configuration, maintenance

nance support structure, or maintenance resource requirements.

d. Providing engineering consulting service and technical assistance to Army field commanders in the installation, operation, and maintenance of equipment; and in the resolution of problems concerning maintainability and maintenance support requirements of materiel in the operating inventory.

e. Managing the resources engaged in these activities.

11-6. The Maintenance Engineering Objective

a. To influence constructively the design or selection of materiel systems being acquired to maximize reliability and provide for ease of fault diagnosis, testing, and maintenance for the soldiers who will perform maintenance, while maximizing operational readiness and minimizing life-cycle costs.

b. To ensure the logistics portion of the support system is developed and contracted concurrently with the materiel system.

c. To ensure the maintenance portion of the ongoing (and worldwide) logistics system is prepared to provide routine support when the materiel system is fielded.

11-7. The Maintenance Engineering Management Effort

a. *Organization.* Maintenance engineering activities are established and identified as elements of the materiel developer. These elements carry out the maintenance engineering functions and tasks outlined below.

b. *Functions.* Maintenance engineering activities:

(1) Participate actively in all phases of the materiel system life cycle. This participation is accomplished as part of the coordinated ILS program for a given materiel system. It includes developing the maintenance concept, providing the maintenance aspects of the support system, providing issues to test planners, and preparing the maintenance plan which is an important part of the Integrated Logistics Support Plan.

(2) Promote and sponsor research programs designed to provide knowledge and information to improve the performance of both the maintenance engineering and maintenance operations subfunctions of materiel maintenance.

(3) Serve as the point of contact for Army field commanders to resolve problems or respond to requests for information concerning materiel systems in the operational inventory.

(4) Evaluate, determine, identify, and review calibration requirements of test, measurement, and diagnostic equipment (TMDE), and ensure the availability

of calibration support.

(5) Continue the configuration status and engineering change accounting program after a materiel system is deployed.

(6) Evaluate equipment performance and maintenance work force performance data on fielded systems for use in establishing support parameters for new and product improved materiel systems.

c. *Control and coordination.* The ILS manager coordinates the acquisition phase logistics effort for new or product-improved materiel systems. The maintenance engineering function is performed in harmony with the total ILS effort so all elements of the corresponding support system are synchronized, mutually supporting, and integrated with the development of the materiel system.

d. *Planning.* The maintenance engineering planning effort is continuous throughout the life cycle of materiel systems. Details required during each phase will be at the level necessary for the phase and for transition to the next phase.

11-8. Equipment Publications

a. Maintenance engineering activities provide for the collection and use of technical data in the preparation of equipment publications. Qualitative and quantitative requirements for the preparation and acquisition of maintenance technical data and publications are analyzed continually and revised to facilitate use by operating and maintenance personnel.

b. Equipment publications (e.g., technical manuals (TM), technical bulletins (TB), and lubrication orders (LO) are developed and published for each item of maintenance-significant materiel introduced into the inventory. Modification work orders (MWO) are prepared only as needed. Depot maintenance work requirements (DMWR) are prepared for those items for which depot overhaul requirements are anticipated (see paragraph 11-9).

c. These publications assist in documenting the maintenance support structure designed during the maintenance support development effort and provide technical guidance for the operation, evaluation, maintenance, and spare/repair parts support of the materiel system, including modifications.

d. The Maintenance Allocation Chart (MAC), included in TMs, reflects the approved maintenance concept. The repair parts and special tools lists (RPSTL) and the narrative portions of equipment publications are designed to be consistent with the MAC.

e. Equipment publications are essential parts of the support systems of all materiel systems. Therefore, as a part of the ILS program, materiel developers co-

ordinate TMs with the combat developer. These publications are also a part of the maintenance system support package and are tested during development and operational testing.

f. Duties and responsibilities of specific organizations and agencies which deal with equipment publications are contained in AR 310-3.

11-9. Depot Maintenance Work Requirements

DMWRs are prepared for each item of equipment for which depot maintenance tasks are identified.

Section III. MATERIEL MAINTENANCE OPERATIONS MANAGEMENT

11-10. Maintenance Operations Management

Maintenance operations management focuses on those actions required to execute the plan for the maintenance of a fielded weapons/equipment system. Operations encompass the development and management of programs and activities designed for the physical performance of maintenance tasks. (AR-750-1 provides additional information on related doctrine.)

11-11. Army Maintenance System

a. *The Levels of Maintenance.* The four levels of maintenance (depot, direct support, general support and unit) provide a means for managing maintenance operations by: relating maintenance operations to other military operations; facilitating assignment of responsibility for specific maintenance operations tasks to specified levels of command; permitting an orderly and efficient distribution of maintenance resources; and ensuring maximum integration of the maintenance tasks performed by personnel throughout maintenance operations.

(1) There are three levels of aircraft maintenance. They are.

(a) Aviation unit level maintenance (AVUM)

(b) Intermediate level maintenance (AVIM)

(c) Depot

b. *Unit Maintenance.* This level of maintenance is the responsibility of the unit commander in maintaining the operational readiness of equipment assigned or under the unit commander's control. It includes preventive maintenance services and those organizational level repairs authorized in appropriate technical publications.

c. *Direct Support (DS) Maintenance.* DS maintenance is performed in support of the user. It is

The objective of a DMWR must be stated; i.e., restore useful life to 80-percent like new; restore item to code A or B condition; restore to meet criteria for domestic-issue or oversea shipment; and accomplish repairs and replacements as necessary to bring an end item to a serviceable condition. DMWRs may be in the form of a hard-copy manual including line drawings, microfilm, microfiche, or a combination of these.

characterized by high mobility, a forward orientation, and repair by replacement.

d. *General Support (GS) Maintenance.* GS maintenance is performed in support of the theater supply system by designated TOE and TDA units. These units are located at echelons above corps, operate in semifixed or fixed facilities, are semimobile, and are job or production line oriented for repair of class VII and class IX items.

e. *Depot Maintenance.* This level of maintenance is the responsibility of the Army Materiel Command (AMC). It is performed by organic Army depots, depots of other Department of Defense (DOD) elements, and commercial contractors. Depot maintenance augments depot stocks of serviceable materiel and supports unit and intermediate maintenance activities by using more extensive shop facilities, and personnel of higher technical skill than are available at lower levels of maintenance. Tasks in this level normally consist of the following: inspection and testing; modification; analytical; calibration; overhaul; and fabrication of items not supported by the supply system in support of national maintenance point (NMP) requirements.

11-12. Maintenance Operations

Maintenance operations are performed by the lowest level of maintenance activity with the capability, capacity, and authority to perform the work. To the maximum practical extent, this should be performed at or near the site of equipment failure to minimize repair cycle time, transportation and pipeline inventory costs, and increase equipment availability to operating units. The MACs in equipment publications prescribe the specific scope of maintenance authorized to be performed at each level and engineered performance standards ("worktime" figures) established for each maintenance task.

11-13. Army-in-the-Field Materiel Maintenance

Army-in-the-field maintenance activities sustain the operational effectiveness of the force. They operate in accordance with the plans and equipment publications prepared by the national maintenance points (NMP). They are concerned with the conduct and management of the organization and support categories of materiel maintenance.

a. Unit maintenance. At this level, maintenance is characterized by quick turnaround repair by replacement, minor repairs, and performance of scheduled services.

(1) Maintenance tasks performed at unit maintenance include minor repairs, adjustments, cleaning, lubrication, tightening, and repair by replacement.

(2) Unit maintenance is performed by the operator or crew, company maintenance section, or organic maintenance teams (MT) deployed from the combat or combat support battalion maintenance section. The maintenance team is specially trained and equipped to conduct battle damage assessment (BDA) or repair. While BDA and repair techniques have been practiced in the Army for several years, the formal application of the techniques in DA publication needs to reference the fact that final publication of these manuals have not been completed. Repairs are made onsite or in the combat trains, as the tactical situation dictates. If repairs are beyond the capability of the MT, or MT are unavailable, the unit requests support from the forward support maintenance company. The maintenance support team (MST) from the forward support maintenance company decides if the equipment is nonreparable by the unit, is to be repaired onsite, recovered, or evacuated.

(3) Repair Parts supply for unit maintenance. This level maintains a prescribed load list (PLL) which consists of items on the mandatory parts list and selected demand supported items. These items are needed to perform preventive maintenance checks and services, scheduled services, and designated mission essential maintenance operations only.

b. Direct support and general support maintenance.

(1) Direct support (DS). DS maintenance is performed in support of the user. Units performing this level of maintenance are tailored to perform repair and return to the user. DS maintenance units are employed at different locations, but the tasks performed are the same. The focus of DS maintenance is mobile support as far forward as

possible, repair by replacement, and maintaining high volume, fast moving operational readiness floats (ORF).

(a) Divisional DS maintenance units are structured to provide dedicated support to brigades and battalions. This includes repair of selected high usage components for reparable exchange (RX).

(b) Nondivisional DS maintenance units have an area support mission. Designated units have the additional mission of providing backup support to the divisional maintenance units during surge periods and providing a reconstitution capability. When providing backup support, the DS maintenance unit is assigned highly mobile augmentation teams; e.g., artillery, tank, or engineer teams.

(c) In addition to the area support mission, other designated nondivisional DS maintenance units are also provided augmentation teams when in support of corps or echelons above corps (EAC) forces, as required.

(d) Maintenance tasks at this level include BDA, diagnosis, fault isolation, repair by replacement, and repair of selected high usage components in support of the DX system. Each DS unit also establishes and operates maintenance collection points (MCP) and base maintenance areas for support of all customer units.

(e) MCP are locations where skills, tools, and repair parts are concentrated to quickly repair critical equipment for return to the using unit. If repairs cannot be made at these points, a decision is made to either evacuate the equipment or salvage it. Equipment is evacuated to the maintenance unit having the repair capability required. All evacuation operations are coordinated with the appropriate materiel management centers (MMC) which, in turn, request transportation from the division movement control officer or movement control center (MCC).

(f) Most DS forward maintenance units have a repair parts (class IX) direct support supply missions. DS maintenance units also maintain shop stock for support of assigned maintenance missions.

(2) General support (GS). General support (GS) maintenance is performed in support of the theater supply system (except for aviation) through the repair of assemblies, components and modules, DX items, printed circuit boards (PCB), and ORF. GS maintenance is performed by designated TOE and TDA units. The units are normally located at EAC and operate in semi fixed or fixed facilities, and are semimobile. GS maintenance units are job or

production line oriented for repair of class VII and class IX items.

(a) Maintenance tasks at this level include BDA, diagnosis, and repair of assemblies, components and modules, and PCB.

(b) Maintenance of theater reserve stocks is an GS maintenance task.

(c) Repair parts stockage in GS maintenance units is limited to items required to support assigned maintenance missions. These units have no supply support missions. Their source of supply for class IX, except parts for communications security equipment (COMSEC), is EAC repair parts supply companies. COMSEC repair parts are provided by the COMSEC logistics supply company which maintains the theater ASL for the COMSEC commodity.

11-14. Army Wholesale Materiel Maintenance.

The wholesale materiel maintenance activities of the Army include:

a. Performing maintenance engineering to include the development, documentation, and timely deployment of a system for the support of new or modified supportable end items and weapon systems.

b. Discharging other assigned materiel maintenance and maintenance related supply responsibilities by wholesale level materiel managers as outlined in AR 750-2 NMPs are established by wholesale level materiel managers to perform maintenance engineering and other assigned wholesale maintenance tasks for assigned weapons systems and classes of supply. These NMPs are assisted by research and development activities, national inventory control points (NICP), national level data banks, and other specialized agencies, and by the producers of the systems or equipment used by the Army and other commercial firms under contractual arrangements.

c. Supporting the overall Department of the Army (DA) inventory management program by the performance of depot maintenance. This activity is normally performed only by AMC depots in the Continental United States (CONUS). They are used as an alternative or supplement to new acquisition and as a source of serviceable assets to meet DA materiel requirements. Programs for the depot maintenance of materiel, except those for the repair and return to Reserve component users of equipment, are approved by Headquarters, Department of the Army (HQDA) and controlled by wholesale level materiel managers under the mentorship of the Deputy Chief of Staff for Logistics

(DCSLOG), DA. The Reserve components repair and return-to-user depot maintenance program is controlled by the U.S. Army Forces Command (FORSCOM) and coordinated with DCSLOG, DA. Approved depot maintenance programs are executed by designated Army arsenals and depot maintenance facilities; by agreement with other military services; and by contractual arrangement with commercial firms. Such repair programs are planned and scheduled based on the needs of the supply system and the DX program, and in accordance with the availability of the required repair parts and other maintenance resources.

11-15. Contract Maintenance.

a. Contract maintenance plays a significant role in fulfilling the Army's maintenance mission. It is used particularly to meet peak loads (in order to avoid hiring and firing), and for noncombat-essential equipment. The use of commercial facilities also underwrites the Army's capacity to meet the greater maintenance demands which would result from partial or total mobilization. Since contract maintenance in the Army is generally performed by relatively small firms, it also makes an important contribution toward implementing Government policy encouraging small business participation in military acquisition programs (Office of Management and Budget (OMB) Circular A76).

b. Contract maintenance has its principal application in the following areas:

(1) For accomplishment of maintenance requirements which exceed the military capacity retained to support mission-essential materiel.

(2) For accomplishment of maintenance requirements in support of nontactical elements when the military control and performance of such work are not required for military effectiveness, personnel training, or the maintenance of an overseas personnel rotation base.

(3) For maintenance support of materiel as may be necessary to augment the military capacity, normally on a one-time basis to accomplish a specific task.

(4) When it is desirable to augment military maintenance capability for an interim period to attain an earlier operational status for new military materiel being introduced.

(5) When a large and steady workload of overhaul and modification maintenance can be anticipated.

(6) When the extent or complexity of modifications or modernization work to be accomplished requires the technical qualifications of the original manufacturer.

(7) When the leadtimes and processes of maintenance by contract would not result in substantially increased cost for acquisition of repair parts

to fill an enlarged repair cycle pipeline.

(8) When requirements are proprietary/mandatory (sole source).

Section IV. MAINTENANCE INFORMATION MANAGEMENT

11-16. Maintenance Information Requirements

a. The effective management of the different categories of maintenance requires extensive reporting and information flow through the Army levels. In general, this information relates to five major areas of concern:

(1) The availability and condition of maintenance resources, such as tools, repair parts, shop space, and personnel.

(2) The actual use of these maintenance resources.

(3) The availability and condition of equipment.

(4) Equipment maintenance history.

(5) Depot maintenance and maintenance support cost accounting and production reporting.

b. At each echelon of management, specific kinds of information may represent a recurring requirement or may be required only occasionally as requested.

11-17. Installation of Logistics Maintenance Management Information Systems

a. A prime example of an installation logistics system is The Army Maintenance Management Systems (TAMMS). Maintenance management is currently standardized under this system; however, command-unique systems for installation tables of distribution and allowances (TDA) maintenance operations do exist. The U.S. Army Training and Doctrine Command (TRADOC), FORSCOM and WESTCOM use the Maintenance Information Management System (MIMS) at specific installations. MIMS is designed to provide a standardized method whereby maintenance managers can obtain information necessary for planning and controlling TDA support maintenance shop operations. The system is intended to increase materiel readiness by minimizing the average turnaround time of equipment to supported units and to maintain flexibility in maintenance operations so high-priority jobs, additional work, or rework requirements can be accomplished with minimum disruption to other work in process. Further, scheduled ranking criteria must be established in order that jobs may be scheduled into the shop work centers with adequate information to relate what is expected to meet delivery require-

ments and to follow up job schedules to ensure delivery requirements are met. The MIMS is also designed to predetermine resource requirements to the maximum extent possible prior to job order scheduling and expedite the delivery of parts for work in process. The final objectives of MIMS are to produce the most effective results at the least possible cost; improve the timeliness and accuracy of management decisions by providing the essential elements of information (EEI) pertaining to performance and conditions requiring management attention; to standardize, simplify, and minimize reporting requirements; and to use the collected data to satisfy data requirements of higher commands.

b. The Army automated calibration system is designed to provide listings and cards which can be used by Army installations to recall, schedule, control, and report items of equipment included in the calibration program. Items which require A level calibration are included in the control system to provide for scheduling of items requiring calibration by area calibration teams. The output listings of this automated system provide a means of determining and scheduling equipment requiring calibration, a means of determining calibration delinquencies, and a tool for determining calibration accomplishments. DA Form 2416s (cards) are used as hand receipts and as work cards to update the master calibration files as well as to provide information to higher headquarters reporting requirements.

c. Sample Data Collection (SDC) under the purview of AR 750-1 uses sampling techniques to collect essential maintenance and operational data under actual field conditions. SDC is conducted on specific equipment for specific objectives. Data are used to establish a data base for analyzing Maintenance, Logistics Support, Equipment System Performance, Operating and Support costs, Operational Readiness, and Mission Capability. SDC also provides a data base to support Life Cycle Management policies. Most important, not only are SDC data used at the wholesale level, but, they have proved to be an invaluable management tool at the filed MACOM and user level.

d. The Standard Army Maintenance System (SAMS), when implemented, will replace all command-unique maintenance management systems and TAMMS (see para. 18-4 g).

11-18. References

In addition to the references quoted in the body of this chapter, the following publications pertain to maintenance management as shown.

a. Army Regulations (AR).

37-55	Uniform Depot Maintenance Cost Accounting and Production Reporting System
37-100	Account/Code Structure
220-1	Unit Status Reporting
220-10	Preparation for Oversea Movement of Units
310-3	Preparation, Coordination, and Approval of Department of the Army Publications.
700-9	Policies of the Army Logistics System
700-18	Provisioning of U.S. Army Equipment
700-126	Logistics Basic Functional Structure
700-127	Integrated Logistics Support
702-13	The Army Warranty Program
710-2	Supply Policy below the Wholesale Level
725-50	Requisitioning, Receipt, and Issue System

750-1	Army Materiel Maintenance Concepts and Policies
750-2	Maintenance of Supplies and Equipment, Army Materiel Maintenance, Wholesale
750-37	Sample Data Collection
750-43	Test, Measurement, and Diagnostic Equipment (TMDE)
<i>b. Department of the Army Pamphlet (DA Pam).</i>	
325-10	Standards of Statistical Presentation
700-24	Sample Data Collection
738-750	The Army Maintenance Management System
<i>c. Field Manuals (FM).</i>	
29-23	Direct Support Maintenance Operations (Nondivisional)
29-24	General Support Maintenance Operations
29-30-1	Nondivisional Direct Support Maintenance
54-10	Logistics
100-10	Combat Service Support
<i>d. Technical Manuals (TM).</i>	
38-750-1	The Army Maintenance Management System (TAMMS) Field Command Procedures

PART SIX: TRANSPORTATION

CHAPTER 12

MANAGEMENT OF TRANSPORTATION OPERATIONS

Section I. TRANSPORTATION SYSTEM ORGANIZATIONS AND ACTIVITIES

12-1. General

The transportation system, as discussed within this chapter, will address not only the obvious requirements of a portion of the Army's physical distribution system, but also the agencies that are within the transportation network and the missions assigned to each. The challenge of the logistician is to know the capabilities and limitations of the defense transportation system and organize and plan the accomplishment of the mission accordingly. The transportation network is not only a means of moving people and things, but is also the principal buffer of the physical distribution system with the potential for providing elasticity in the time required for delivery of materiel. This elasticity comes about based on the assignment of a required delivery date (RDD). Based on the time available for the shipment, cargo can be consolidated and routed to provide the materiel to the customer on time, at the least cost to the Government. It must be realized that not all the modes of transportation are capable of moving materiel at the same speed. The logistician cannot always select the fastest mode of transportation because with speed comes increased cost. The use of less costly modes of movement results in additional considerations. For example, as the time expands between consignor and consignee, the cheaper cost of transportation is offset by a requirement for more materiel in the pipeline to maintain an even flow of materiel to the customer. The task of the logistician is to effect a balance between materiel acquisition and transportation modes for the least cost to the Government while increasing the materiel readiness of the Army.

12-2. Organizations Outside the Department of Defense (DOD)

a. The DOD transportation organization and management are influenced by many external organizations and agencies. The more important of these are:

- (1) Department of Transportation (DOT).
- (2) Interstate Commerce Commission (ICC).
- (3) Federal Maritime Commission (FMC).
- (4) National Transportation Safety Board (NTSB).

(5) State Public Utility Commission (PUC) or State Department of Transportation Offices.

b. The DOT is an executive department of the U.S. Government and is responsible for the development of transportation policies and programs that contribute to providing fast, safe, efficient and convenient transportation at the lowest cost consistent with those and other national objectives, including the efficient use and conservation of the resources of the U.S. The DOT coordinates transportation service to be provided by private enterprise to the greatest extent feasible; encourages cooperation of Federal, State and local government, carriers, labor, and other interested persons to achieve transportation objectives; stimulates technological advances in transportation; and provides general leadership in identifying and solving transportation problems. The following agencies are part of DOT and perform regulatory functions related to specific transportation modes or activities: U.S. Coast Guard (USCG), Federal Aviation Administration (FAA), Federal Highway Administration (FHWA), Federal Railroad Administration (FRA), Maritime Administration (MARAD), Urban Mass Transportation Administration (UMTA), and the Research and Special Programs Administration (RSPA) which administers programs for the safe transportation of hazardous materials.

c. The ICC is an independent regulatory agency and is responsible for carrying out the National Transportation Policy. This policy provides for the development, coordination, and preservation of a transportation system that meets the transportation needs of the U. S., including the U.S. Postal Office and national defense. The ICC recognizes and preserves the inherent advantage of each mode of transportation; promotes safe, adequate, economical, and efficient transportation; encourages sound economic conditions in transportation, including sound economic conditions among carriers; encourages the establishment and maintenance of reasonable rates for transportation without unreasonable discrimination or unfair or destructive competitive practices; grants carrier operating authority and approves applications to construct/abandon railroad lines; cooperates with each State and the officials of each State on

transportation matters; and encourages fair wages and working conditions in the transportation industry.

d. The FMC is an independent regulatory agency that administers and enforces provisions of the Shipping Act of 1916 and 1984, and Section 19 of the Merchant Marine Act of 1920. The FMC reviews and monitors common water carrier agreements in both domestic and foreign trade, and investigates discriminatory practices (protective restrictions, surcharges, etc.) by foreign governments and/or carriers affecting U.S. ocean borne foreign trade.

e. NTSB is an independent agency that investigates transportation accidents to determine their cause. Based on their investigation, they make recommendations for legislative or judicial action to prevent recurrences of similar accidents.

f. State PUC or State DOT. State agencies that regulate intrastate transportation. These agencies regulate economic and safety programs similar to those of the ICC and federal DOT; however, their jurisdiction is limited only to transportation movements originating and terminating within their state borders. DOD traffic managers need to know state transportation regulations when making intrastate shipments.

12-3. The DOD Transportation System

Each of the agencies and individuals discussed in this paragraph play key roles in providing guidance, direction, and support to the Army transportation system.

a. *Secretary of Defense.* The Secretary of Defense (SECDEF) has two primary sources of advice on matters affecting transportation. The Assistant Secretary of Defense for Production and Logistics (ASD (P&L)) advises the Secretary of Defense on general logistics policy and the Joint Chiefs of Staff (JCS) give advice on matters affecting multiple support operations. In addition, single managements have been established for the management of land, sea, and air modes of transportation (see para. 12-4). DOD relies almost exclusively on the commercial transportation industry to meet defense transportation requirements within the Continental United States (CONUS). Consequently, the availability of a diverse, efficient transportation industry is fundamental to national security.

b. *Transportation Management Agencies.*

(1) *J4, JCS.* This JCS agency concerns itself with the capability of deploying and sustaining military forces worldwide. Within J4, the Deputy Director for Logistics/Strategic Mobility uses subordinate staff elements to evaluate current movement capability and analyze future requirements.

(2) *ASD (P&L)* is a staff assistant to the SECDEF in several functional fields, one of which is transportation. To assist him or her in this area, he or she has a staff assistant in the Director of Energy and Transportation Policy.

(3) *Director of Energy and Transportation Policy.* General transportation policies for the ASD (P&L) are developed by this director. The directorate is delegated broad responsibilities for transportation and warehousing in the domestic, foreign, and international areas. These responsibilities include developing, recommending, and evaluating policies, practices, systems, and procedures incident to both current operations and mobilization planning. This office also directs the single managers in transportation and traffic management.

c. *The Joint Transportation Board (JTB).* The JTB is an agency of the JCS responsible for ensuring that common-user movement resources assigned or available are used to achieve the maximum benefit in meeting objectives. When a situation exists in which requirements exceed movement capabilities and the services cannot resolve conflicting interests, the JTB is responsible for the allocation of transportation resources.

12-4. DOD Transportation Management Agencies

a. *General.* United States Transportation Command (USTRANSCOM). The USTRANSCOM was organized in April 1987 as a unified command with the mission of strategic mobility planning to integrate global air, land, and sea transportation capabilities. This command consists of the Air Force's Military Airlift Command (MAC), the Navy's Military Sealift Command (MSC), and the Army's Military Traffic Management Command (MTMC). During peacetime, each service retains operational control of its forces assigned to the USTRANSCOM. In wartime, the USTRANSCOM will be the unified manager for all U.S. strategic transportation operations.

b. *MTMC.*

(1) MTMC is a major command of the Army, and is the operating agency through which the Secretary of the Army executes the responsibility as the DOD single manager for military traffic, land transportation, and common user ocean terminals. Its mission is to provide responsive, flexible support in peace and war to the operating forces of the U.S. Army, Navy, Air Force, and Marine Corps. MTMC provides the HOW of movement management when the military shipper decides WHEN, WHERE, and WHAT is to be moved. As a transportation operator, MTMC provides ocean terminal services to DOD. As a transporta-

tion manager, MTMC manages freight and passenger transportation in CONUS and manages the worldwide personal property moving and storage program. As a transportation adviser, MTMC evaluates defense transportation activities and recommends system improvement to the SECDEF and to the military services (see AR 55-355).

(2) Field activities commanded by HQ, MTMC are: Eastern and Western commands in CONUS; Transportation Engineering Agency; and MTMC Transportation Terminal Command, Europe (TTCE).

(3) MTMC Eastern Area has responsibility for traffic management in the 27 Eastern States and for ocean terminal operations on the Atlantic Coast and Gulf Outport, New Orleans, and all port operations in Texas and Louisiana. It also controls routing of bulk petroleum, oils, and lubricant products throughout the CONUS; manages the Defense Freight Railway Interchange Fleet; monitors the worldwide DOD personal Property Movement and Storage Program for the Eastern states; and manages the DOD contemporary storage Regional Storage Management Offices at Bayonne, New Jersey and Atlanta, Georgia.

(4) MTMC Western Area is responsible for traffic management in the western states and for ocean terminal operations on the Pacific Coast; Naha, Okinawa; Yokohama, Japan; and Pusan, Korea. It also commands eight Military Air Traffic Coordinating Units (MATCU), located throughout the CONUS to assist passengers passing through the aerial ports and serve as the single point of contact at the aerial port to provide liaison between the port and the shipper services and Defense agencies to ensure orderly flow of military traffic through the airlift system. MTMC Western Area analyzes international airlift procedures; monitors the Worldwide DOD Personal Property Movement and Storage Program for its area of responsibility, and manages DOD contemporary storage through Regional Storage Management Offices in Oakland, California and Topeka, Kansas.

(5) MTMC Transportation Terminal Command, Europe, headquartered at Rotterdam, the Netherlands, commands assigned water terminal operations in the European area are located throughout nine European countries and the Mediterranean; operates water terminal clearance authorities to control export cargo

movement into ocean terminals; provides transportation terminal planning support for mobilization plans and other military operations; and functions as Military Sealift Command representative in those ports as assigned.

(6) The MTMC Transportation Engineering Agency produces land transportability criteria and guidance for the DOD; publishes all-mode transportability guidance for the Department of the Army; reviews new items of Army materiel and equipment to assure they are transportable; provides traffic and transportation engineering services to the DOD; and performs functional and multi-mode analyses of transportation systems.

c. MSC.

(1) MSC is the single manager for ocean transportation. The Secretary of the Navy has been given the responsibility for this phase of the military transportation system. The MSC, a major operating force of the Navy, is organized as a worldwide command. As the single manager operating agency for ocean transportation, MSC performs a fourfold mission:

(a) Provides an immediate sealift capability in emergencies.

(b) Plans for expansion in emergencies.

(c) Provides peacetime ocean transportation for DOD and other authorized agencies.

(d) Provides ships for oceanographic exploration, range instrumentation, missile tracking, etc.

(2) MSC coordinates closely with the shipper services (Army, Navy, Air Force, and Marine Corps), and with the other single manager transportation agencies (MTMC and MAC). The relationship with MTMC is especially close in the CONUS area commands because military cargo flows to MSC through the movement control channels of MTMC.

(3) MTMC submits customer shipping requirements to MSC in three major segments: dry cargo, passenger, and petroleum. MSC then has four sources of sealift capability by which it can meet these shipping requirements: the MSC Nucleus Fleet, the Merchant Marine, the National Defense Reserve Fleet, and, as a last resort, foreign flag shipping including Effective U.S. Control (EUSC) ships.

(4) The active Merchant Marine, the main resource for augmenting military sealift, is composed of berth liners, which are regularly scheduled on specific routes, and tramps, which are not regularly scheduled or routed and which operate on an opportune-lift basis.

(5) The National Defense Reserve Fleet is that body of inactive ships most of which were built during World War II and are not required in peacetime by either maritime industry or the military. During emergencies, these ships can be activated and used by MSC and operated by commercial companies under General

Agency Agreements.

(6) Special projects form another aspect of MSC operations. MSC have been involved in such diverse programs as oceanographic and hydrographic research, missile range instrumentation and tracking, helicopter maintenance and repair, and tracking and communications for National Aeronautics and Space Administration (NASA) Apollo space project.

d. MAC.

(1) The Secretary of the Air Force is designated the single manager for airlift service. The Secretary performs this mission through the MAC which provides common-user airlift service for all components of DOD, and as authorized, for other agencies of the U.S. Government, between points in the U.S. and oversea areas, and between and within oversea areas. MAC became a specified command in 1977. As a specified command, MAC reports to the President through the SECDEF during declared emergencies. Further, MAC is charged with maintaining, in a constant state of readiness, the military airlift system necessary to perform all airlift tasks, under emergency conditions, as assigned by the JCS in approved war plans and appropriate JCS in approved war plans and appropriate JCS and Air Force guidance documents. Peacetime training ensures the ability to carry out the wartime deployment mission. A valuable byproduct of this training is the airlift capability used to support U.S. forces throughout the world. Airlift requirements, established by various Government agencies, are fulfilled by MAC in accordance with JCS directed priorities. The MAC organic airlift force consists of C-130 Hercules, C-141 Starlifters, and C-5 Galaxies.

(2) MAC active military force is augmented by the wartime mobilization assignment of its Reserve forces (Air Force Reserve and Air National Guard). The capability of this augmentation force is supplied on a continuing basis to support routine logistical operations. These readily available resources are an integral part of the total strategic airlift force and are exercised periodically to test their effectiveness.

(3) More than 20 U.S. civilian airlines are under contract to augment the MAC peacetime airlift. They also commit their most suitable aircraft to the Civil Reserve Air Fleet (CRAF) for emergency airlift requirements of a military contingency. This would allow MAC aircraft to concentrate on purely military missions at that time. Thus, the airlines augment MAC during peace and war.

(4) MAC is also responsible for the provision of specialized airlift wings to perform the following missions:

(a) Provision of air transport to the President of the United States, and U.S. and foreign dignitaries.

(b) Provision of aeromedical evacuation of sick

and wounded DOD personnel within CONUS and near offshore areas.

(c) Provision of specialized aircrew training for the C-141 and C-5 aircraft.

(5) MAC also meets global requirements for complex support activities through four technical service organizations:

(a) The Air Weather Service plans, programs, and provides operational aerospace environment support to the Air Force and Army. Using computerized systems, satellites, and a variety of specialized aircraft, Air Weather Service furnishes environmental services used in a military decisionmaking processes.

(b) The Aerospace Rescue and Recovery Service (ARRS) fulfills the global need for search, rescue, and recovery of personnel and U.S. aerospace equipment on land and sea.

(c) The Aerospace Cartographic and Geodetic Service provides mapmaking and gravity measuring data to a variety of governmental agencies.

(d) The Aerospace Audiovisual Service compiles and maintains a pictorial record of Air Force combat and support activities worldwide; provides optical instrumentation for engineering analysis; and provides products to satisfy Air Force requirements for training, motivation, information, technical reporting, and special projects.

Neither the Marine Corps nor Defense Logistics Agency (DLA) operate any transportation facilities of their own, but rely instead on available military and commercial capabilities.

12-5. DA Transportation Service Organizations

a. The Assistant Secretary of the Army (Installations, Logistics, and Financial Management) (ASA) (IL&FM) includes, among his responsibilities, the distribution and transportation functions. In this role he monitors the transportation service activities of the Army and establishes certain broad policies.

b. Under the General Staff supervision of the Deputy Chief of Staff for Logistics (DCSLOG), the Director of Transportation, Energy, and Troop Support is the focal point for the control and coordination of Army transportation services. He ensures integration of transportation concepts, doctrine, and related employment of equipment into the total doctrine for operations of the Army in the field. He also influences the initiation of new concepts and provides active support for the improvement of mobility worldwide.

c. The Directorate for supply, Maintenance, and Transportation, Army Materiel Command (AMC), is responsible for plans, programs, and doctrine; and the coordination of certain traffic management activities within AMC.

d. The AMC Logistics Control Activity (LCA) is tasked with monitoring supply and transportation actions relating to Army-sponsored requisitions placed on the wholesale supply system and reporting on the performance of the total logistics pipeline. The LCA maintains a computerized data known as the Logistics Intelligence File (LIF). The LIF contains supply and shipment status and other information on requisitions, transportation receipts, and transportation lift data. The LCA also serves as the Army's air clearance authority for all Army-sponsored, CONUS outbound air shipments. Additional data on LCA/LIF is outlined in FM 38-704.

e. Installation Transportation Officers/Depot Transportation Officers (ITO/DTO) are members of the military activity to which they are assigned and are the commander's staff advisors on all transportation matters. They participate in the transportation aspects of installation/depot master planning, traffic control, supply management, procurements, and other activities in which transportation is a factor. They, in effect, are the installation/depot traffic managers, and their mission is to provide transportation services in support of the installation/depot mission in consonance with the desires and policies of the commander. In performing this mission, the ITO/DTO must ensure compliance with the laws, tariffs, and regulations of the regulatory bodies (applicable to military installations at all levels of command) governing the shipment of personnel and materiel via commercial carriers. These include DOT, ICC, American Trucking Association, Association of American Railroads, and U.S. Coast Guard regulations applicable to the individual modes of transportation. The ITO must ensure compliance with laws and regulations relating to the official use of motor vehicles in support of the installation or activity. Since most military shipments begin or end at a military installation, the ITOs/DTOs are probably the most essential link in the Army Transportation System. Their functions, responsibilities, and authorities are addressed in the Military Traffic Management Regulation, AR 55-355.

12-6. Trends in Transportation

a. *Containerization.* Perhaps the most important transportation innovation in recent years is the increased use of containers to move cargo. DOD has used container express (CONEX) containers within the existing transportation pipeline for a number of years. Today, however, containerization is being thought of not as a physical piece of equipment but as a system of transportation offering uninterrupted transportation through movement of cargo from point of origin to ultimate oversea destination using all modes of transportation. This concept has been advanced to a

large degree by the ocean carriers' use of standard commercial intermodal containers commonly referred to as SEAVANS. The most commonly available containers are the 20-, and 40-foot lengths and are designed for rapid interchange between special rail cars, trailer chassis, and ships. The advantages of this method of operation are reduced cargo handling, reduced loss and damage, reduced packing requirements, greater ship utilization, and increased port/terminal capability. It has been estimated that 80 percent of DOD cargo is containerizable, making it likely that this trend will continue. Because of the costs associated with containers, rapid turnaround is of vital importance. To avoid costly detention charges, as well as ensure availability, controls are required to ensure rapid unloading and return of containers to carriers (see FM 55-70, Army Transportation Container Operations, and FM 54-11, Container Movement and Handling in the Theater of Operations).

b. Container-Oriented Distribution System (CODS). Efforts are underway to develop and expand the use of containers (both military owned and commercial containers) in the distribution of all commodities eligible for containerization. Part of the CODS initiative is to accomplish the various actions identified in the Containerized Ammunition Distribution System (CADS) Program Management Plan which are oriented toward increasing the amount of containerized conventional ammunition shipped overseas. The CODS initiative will result in an overall, long-range Army Master Container Program (AMCP) to ensure that all facets of containerization are considered and used by DA wherever possible and in the Army's best interest.

c. Application of Automatic Data Processing (ADP) and Communications in Management of Transportation.

(1) *Automated System for Transportation Data (AUTOSTRAD).* Autostrad is comprised of various subsystems designed to provide automation support to all aspects of MTMC transportation movement management and terminal operations responsibilities.

(2) The following are major DA Transportation Standard Army Multi-Command Management Information Systems (STAMMIS):

(a) *DAMMS-R* is designed to support transportation management and operations within any theater of operations in both peace and war. It ties together all levels of movements management and all modes of transportation from the transporta-

tion motor company, highway regulation teams, trailer transfer points, and theater movement control units.

1 *The DAMMS-Cargo Movement Module (DAMMS-CMM)* provides automated management of inbound cargo from the theater port of debarkation to its destination. It maintains visibility of cargo, locates and obtains status, and controls the flow of cargo shipments moving within the theater.

2 *The DAMMS—Movement Planning Module (DAMMS-MPM)* enables theater movement planners to evaluate and adjust theater-level wartime movement plans. It contains a subsystem that calculates vehicle loading requirements for cargo and personnel, and a subsystem that describes characteristics of physical distribution facilities such as roads, railways, airfields, and inland waterways.

(b) *DA Standard Port System—Enhanced (DASPS-E).* DASPS-E performs ocean terminal cargo documentation functions for both incoming and outgoing cargo; maintains history files on all cargo; processes financial data for administering contracts and interservice support agreements; and produces documentation for receipt planning, inventory accounting, movements, and control of cargo at overseas ports. DASPS-E interfaces with the LIF (para 12-5d) and the MTMC Terminal Management System (TERMS).

(3) *Aerial Port documentation and Management Systems (ADAM I), (ADAM II and (ADAM III).* ADAM I is a nonsophisticated EAM system using punch card source documents for cargo documentation. It is used in remote air terminal locations. ADAM II is an air cargo documentation and information system using the B-3500 computerized system. Both ADAM I and ADAM II provided DOD receipt and lift data, and provide air movement data to the logistic intelligence file for CONUS outbound and retrograde MAC channel movements. ADAM III is a sophisticated computerized air cargo documentation system (Honeywell Level 6) and is the cargo subsystem from MAC's consolidated aerial port subsystem (CAPS). DAMMS-R will interface with the ADAM systems in the overseas theater.

(4) *Transportation Coordinator Automated Command and Control Information System (TC ACCIS).* TC ACCIS assists unit and installation personnel in preparing for deployment of unit and non-unit equipment and personnel. It provides an automated link between the installation and the deployment community to update movement data and produce deployment-related documentation

and reports. This interactive system will operate on microcomputers at division and below and on minicomputers at installation level.

d. Logistics-Over-the-Shore (LOTS) Operations. A means of providing vital support to a theater of operations when established ports are not available or adequate. LOTS operations involve discharging ships anchored offshore and bringing the cargo in-country over the beach.

e. Watercraft and Materials Handling Equipment (MHE). This involves the development of an improved family of lighterage and harbor craft, and related MHE.

f. Barge-Carrying Ships. Ocean cargo vessels especially designed to load and discharge their own barges offshore away from congested or shallow ports (Seabee and LASH).

g. Intermodality. Containers, containerships, roll-on/rolloff techniques, piggyback service, and other equipment of techniques that facilitate the integration and interchangeability of freight movements between different modes of transportation.

h. Direct Support System (DSS). Transportation plays a significant role in this physical distribution system. The system is designed to move

materiel from the wholesale system to the using units in the shortest possible time and includes the Airline of Communication (ALOC) (FM 38-725). (See Section IV of Chapter 10)

12-7. Shipment of Classified and Sensitive Materiel

Movement of classified and sensitive materials requires special transportation considerations. Chapter 226 of AR 55-355 provides guidance for shipment of this type of materiel. Compliance with DOD 5200.1-R, DOD 4500.32-R for classified shipments and chapter VI of DOD 5100.76-M for sensitive material is required.

12-8. Shipments of Hazardous Materials

The movement of hazardous or dangerous materials requires special transportation considerations. Chapter 216 of AR 55-355 deals exclusively with the transportation of explosives and other dangerous articles. The movement of chemical surety material is covered in AR 50-6; the transportation of nuclear weapons and components is contained in AR 50-5.

Section II. TRANSPORTATION SERVICES IN A THEATER OF OPERATIONS

12-9. General

a. The basic objectives of transportation services overseas do not differ from those in CONUS. The orientation changes from the use of commercial carriers to greater reliance on military units and their organic equipment for the movement of personnel and material. Also, in the combat zone, the selection of modes and routes of transportation is influenced by enemy potential actions and the tactical need. Host-country transportation capabilities and restriction are additional considerations.

b. In the theater of operations, transportation services are provided by the transportation elements of Theater Army (Echelons Above Corps) and corps in three functional areas. These are:

- (1) Transportation mode operations (air, motor, rail, and water transport).
- (2) Transportation movement management (excluding POL by pipeline).
- (3) Terminal operations.

12-10. Base Development Planning for Transportation

a. Adequate logistics support of operational forces is contingent upon the timely development of bases. The capabilities of these bases for supporting various modes of transportation are among

the foremost considerations. During contingency planning, base development requirements will be identified and detailed as an appendix to the logistics annex of the operation plan (OPLAN).

b. In most cases, both ocean and air terminals will be required. Plans must be based on estimates of percentages of cargo which will be brought in by air and by water. These estimates are further broken down into percentages of various types of commodities; e.g., dry cargo, bulk petroleum, and ammunition. The various types of packaging must be considered since these will determine the types of facilities required. Palletized shipments, for example, require facilities radically different from those for containerized shipments. The methods of delivery to the terminal are varied and can greatly influence transportation requirements. Delivery from ship to shore by lighters or by amphibious vehicles may be satisfactory; or movement directly from ship to depot by helicopter may be a useful expedient. Air delivery may be by relatively small aircraft or helicopters to hastily prepared landing strips.

c. Lines of communications connecting terminals with supply organizations and units must be planned to accommodate the potentials of the terminals. A high-capacity air terminal, for example, is of reduced value if the roads emanating

from it are inadequate. When determining gross transportation requirements, the needs of the local civilian population as well as those of the United States and allied military forces must be considered. Requirements for marine terminals, pipelines, and tank farms are determined from an analysis of the type of military operation, the characteristics of the specific environment, and the delivery system to be employed.

12-11. Theater Transportation Services

The theater commander is responsible for coordinating all means of transportation (including that

provided by U.S. forces and by host or allied nations) assigned to the command. The theater commander allocates to the subordinate elements, which may include either subordinate unified or separate service commands, a portion of the total transport capability. A detailed discussion of Army transportation services in a theater of operations is contained in FM 55-1. Figure 12-1 is an organization chart of the transportation organization in a theater of operations.

THEATER TRANSPORTATION

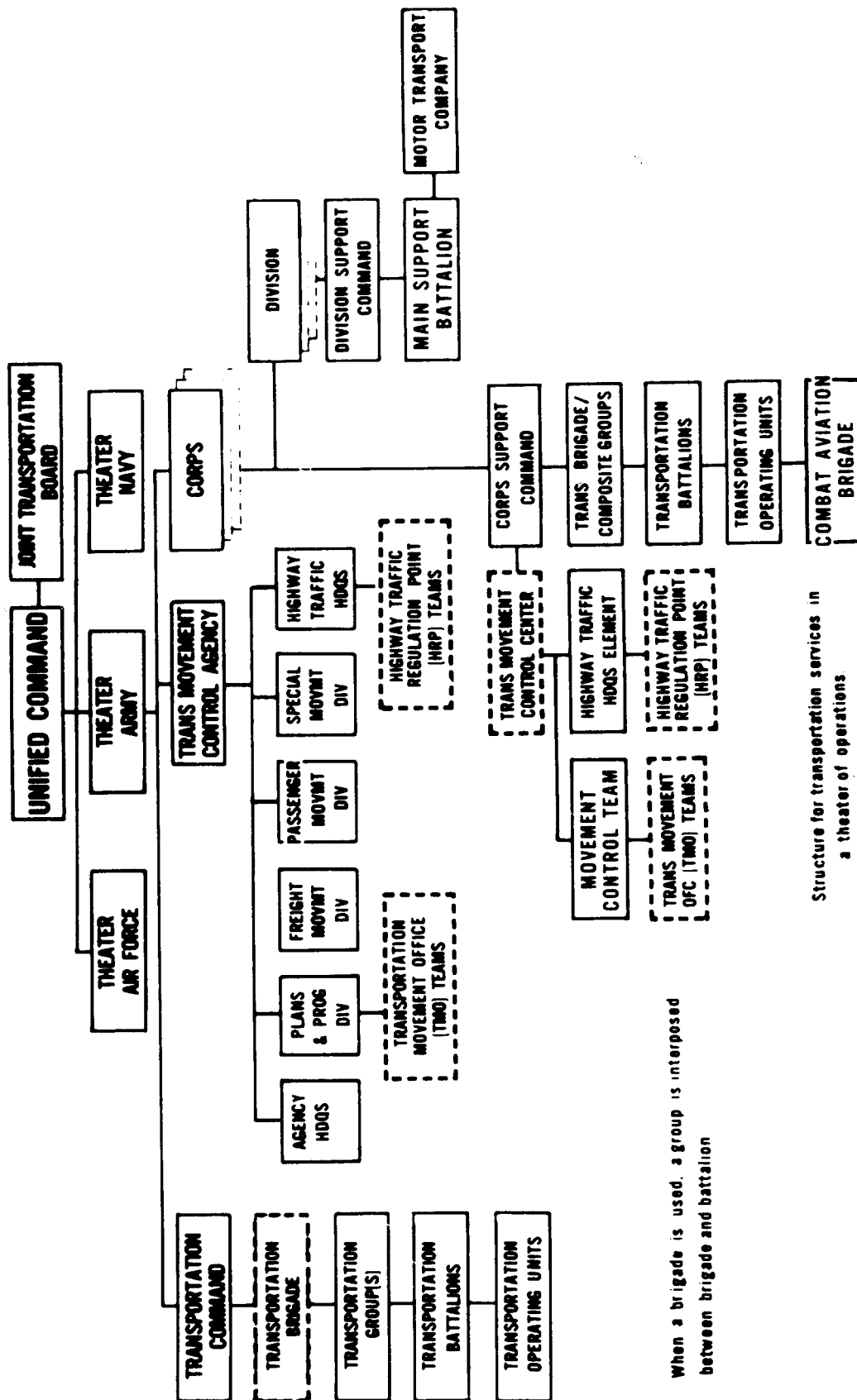

When a brigade is used, a group is interposed between brigade and battalion

Structure for transportation services in a theater of operations

Figure 12-1. Transportation organization in a theater of operations.

a. When the subordinate command to which transport is allocated is a unified command, it is responsible for controlling and coordinating all common service and common user transportation and terminal service allocated to the command, including intertheater air and surface transportation. Where a subordinate unified commander is delegated the responsibility for controlling and coordinating transportation and use of allocated transportation space, the commander may establish a joint or unified movement control center (MCC) to manage the transport capability allocated to him.

b. When no subordinate unified command exists, the theater commander normally delegates to the TA the responsibility for providing and coordinating surface transportation in support of all U.S. forces and for controlling the use of space allocated to the Army for intertheater or intertheater airlift or sealift.

(1) The TA commander, to carry out transportation control and coordination responsibilities, develops and issues policy directives to major subordinate commands which, in most theaters, includes one or more corps and the TA transportation command. These directives are usually the minimum required to facilitate throughput distribution and to ensure effective transportation support under all conditions.

(2) The TA commander suballots the total Army transport capability to subordinate commanders. These commanders are given the responsibility for managing, within prescribed guidelines, the movement capability so allotted and for regulating and coordinating the use of the road space within their respective areas of responsibility.

12-12. Assistant Chief of Staff (ACS), Transportation, TA

a. The transportation functions of the TA are monitored by specialists assigned to the TA General Staff Section of the ACS, Transportation. The primary duties of these specialists are to advise the commander and staff on all transportation matters, to develop plans or planning guidance necessary to provide an efficient transportation service for the command, and to provide technical supervision of all MCCs within the theater. (FM 55-1 contains a more detailed discussion of responsibilities and functions of the ACS, Transportation.) In carrying out the responsibilities to the TA commander, the ACS, Transportation, uses the staff resources and those of the transportation command (TRANSCOM).

b. The TA headquarters (TAHQ) staff is a broad policy and planning staff which operates on a management-by-exception basis. It develops broad policy and planning guidance and does not become involved

in day-to-day operations, planning, implementation, or management. The MCA operates under the staff supervision of the TA ACS, Transportation. It is not necessarily collocated with TAHQ, but must be located in the vicinity of ADP facilities. Technical specialists required for the operation of the MCA are normally provided by TRANSCOM. TRANSCOM performs the complete operational mission which includes operational planning and management, implementing, evaluating plans and directives, and summary reporting to TAHQ. It also provides representation on joint theater boards and committees. Although its organization is flexible, a typical TRANSCOM may include:

- (1) Headquarters and Headquarters Company.
- (2) Signal Detachment.
- (3) Terminal Transfer Companies.
- (4) Motor Transport Group.
- (5) Aviation Battalion.
- (6) Transportation Terminal Group.
- (7) Transportation Railway Group.

c. If required, a Joint Military Transportation Board can be established at theater level. This board recommends allocation of all theater transportation resources in accordance with the theater commander's priorities. The commander of the TRANSCOM normally participates in the activities of the Joint Military Transportation Board.

d. At TA level, transportation functions are carried out by the TRANSCOM. The TRANSCOM, located in the communications zone, is a major mission command of the TAHQ, and is the principal Army transportation headquarters in the theater of operations. The mission of the TRANSCOM is to:

(1) Command and control transportation units and other assigned or attached units required for operation of the TA transportation service.

(2) Provide staff assistance to the TA ACS, Movements, for TA level transportation plans, policies, and procedures.

(3) Coordinate transportation service support matters with other U.S. forces, TA major commands, corps support commands (COSCOM), and host and allied nations.

(4) Control indigenous transportation resources allocated to the TA transportation service.

e. At the corps level, transportation functions are performed by a motor transportation (TMT) group and MCC unit assigned to COSCOM. These organizations are responsible for day-to-day management of the transportation resources and road nets of the corps and for providing line-haul motor transportation and local delivery of personnel and cargo corpswide basis. The support groups of the corps normally have no transportation units assigned. Units in or passing

through the corps rear area and receiving combat service support from the COSCOM support groups are furnished transportation and movements services by the TMT group and the MCC. Battalions of the TMT are dispersed throughout the COSCOM area at locations where their employment can best meet the motor transport requirements of COSCOM. Movement priorities are established by the TA or Corps G-3/G-4, as appropriate, and are implemented by the COSCOM ACS, Transportation, through the MCC. Based on these priorities, the MCC balances requirements against available transport capability and allocates the capability to meet requirements.

f. The transportation group is organized on a building block principle. The group is tailored and its units deployed to meet requirements imposed by terrain, supported troop strength, available transportation net, and intensity of combat. The group coordinates closely with the TA TRANSCOM and directs the establishment of airheads, truckheads, and railheads at sites mutually advantageous to both units and which will facilitate the throughput of cargo and replacements moving forward from the communications zone. The transport capability of the task units attached to the transportation group is allocated by the COSCOM MCC.

Section III. TRANSPORTATION MODE AND TERMINAL OPERATIONS IN A THEATER OF OPERATIONS

12-13. Mode Operations

a. The operation of military railways in a theater of operations is a responsibility of the TRANSCOM and its subordinate railway units. The senior railway unit is responsible for planning the organization and employment of its subordinate railway units. It is probable that in a land mass theater, the basic responsibility for railway operations will be with the host nation and that military units will be utilized to supplement the host nation's capabilities. The rail mode is capable of moving large tonnages over long distances at relatively high speeds. The rail mode is specially appropriate for the movement of containers forward into the theater.

(1) The TRANSCOM is responsible for long-range planning for the employment of the railway transport service. In a combined theater of operations, this planning will be coordinated with the host nation so that the types of units which can be of most value are employed at the most advantageous locations. The general policies and plans developed by the TRANSCOM are furnished to the railway units for their operational planning.

(2) The senior railway unit plans the composition of its subordinate units and delineates the tasks for which each is responsible. In combined operations, the group is primarily responsible for coordination with host nations on such items as operating rules and procedures; combined staffing; the use of repair and maintenance facilities; and record and reporting procedures.

(3) The railway battalion plans and coordinates the activities of the various mission companies under its jurisdiction.

b. Army air transport services for Theater Army Area Commands (TAACOM) are provided by aviation units of TRANSCOM. The primary functions of these units are to —

(1) Provide air transport for command headquar-

ters and for units in the TAACOM area for command control, aerial radiological survey, convoy control, and courier service. In this last named function, they provide a manual backup for the communications system for ADP activities of the command.

(2) Provide the TAACOM commander with an immediately responsive, highly mobile airlift capability for movement of security units and combat forces engaged in rear area security operations.

(3) Move replacements, essential high priority mail, and repair parts.

(4) Augment the aeromedical evacuation service.

(5) Provide feeder service to Air Force terminals providing intertheater and intratheater airlift.

(6) Provide airlift for clearance of ports and terminals.

(7) Provide a heavy lift capability for movement of heavy and outside equipment to include loaded containers, and evacuation of materiel.

c. The Army aviation units assigned to the aviation group of the corps are essentially the same as the aviation units in the TA. In the corps area, requirements exist for air transport of resupply materiel, replacements, medical evacuees, and personnel engaged in liaison, command control, rear area protection, courier service, and convoy control. The aviation units assigned to the aviation group are allocated to the COSCOM for accomplishing these air movement requirements, within their capabilities, except aeromedical evacuation.

d. TRANSCOM motor transport service is organized to serve the theater as a whole, providing necessary flexibility, diversification, concentration, and allocation of transport to rapidly reflect changes in the strategic and tactical situation. The TRANSCOM contributes to economy of operation through centralization of control of its operating motor transport units

to their most forward point of delivery. Motor transport operations include the clearance of breakbulk and containerized cargo from terminals and beaches and the forward movement of such cargo to ultimate consignees.

(1) Transportation intersectional motor transport operations are normally line-haul movements operated for extended distances over controlled main supply routes. Planning for the placement of units to accomplish the intersectional motor transport service is a responsibility of the TRANSCOM and its subordinate elements, the motor transport brigade or group, and the movement control center. The MCC develops a movement program which outlines the tonnage class, area of origin, and area of destination of cargoes to be transported by highway. The senior motor transport unit plans the requirements and disposition of subordinate motor transport units to accomplish the movement plan.

(2) The motor transport battalions plan the location, responsibilities, and employment of their individual truck companies. They assign companies to operate trailer transfer points, main supply route movements, local movements, and feeder movements.

e. The motor transport units assigned to the COSCOM are capable of providing support to all elements engaged in supply, evacuation, maintenance, and administration of a combat force. The corps commander may direct that motor transport units of the transportation brigade be placed in direct support of tactical units in the corps and division areas.

f. Inland waterway operations will be normally conducted by units of the theater terminal group. The inland waterway mode is capable of moving containerized and breakbulk cargo in quantity but at relatively low speeds.

12-14. Terminal Operations

a. Terminal activities in TRANSCOM involve fixed port operations; logistics over-the-shore operations; and terminal transfer operations at inland waterway, truck, rail, and air terminals. Corps terminal activities are limited to transfer operations. The success of through-out operations depends, to a large extent, upon the effectiveness of operative management at the terminals.

b. The primary mission of water terminals in a theater, whether ports or beaches, is to receive and unload inbound vessels and to load and arrange for the movement of personnel and cargo discharged from such vessels forward to their destination. A secondary mission of the terminals is to receive and outline personnel and retrograde cargo.

(1) The transportation terminal group normally is

the senior terminal activity in a theater. When three or more groups are required, a terminal brigade may be assigned to the theater for command and coordination of the groups. The terminal group is a planning and control organization and does not enter into day-to-day pier or beach operations.

(2) The terminal battalion provides command, control, planning, and supervision of attached units. These units may consist of terminal service, boat, or amphibian companies and the necessary service teams for operating tugboats, floating cranes, and patrol and other craft required in port operations. Based upon the vessel manifests and port clearance programs received, the terminal battalion plans the discharge of individual ships. Such planning includes the specific location within the terminal to be used, the method of discharge (floating cranes or shore-side cranes, if required; onshore and offshore discharge if feasible; and order of hatches and cargo within hatches to be worked), and the designation of specific units to work the vessel.

(3) Terminal service and lighterage units perform the unloading of cargo, transporting it to a pier or beach if required, loading it onto inland carrier, and preparing necessary documentation. Terminal service units work closely with the local transportation movement offices to that variations from the vessel discharge plan are coordinated with the mode operators to prevent unnecessary delay to either cargo personnel, or transport equipment.

c. Terminal transfer operations consist of shifting cargo from one mode of transportation to another or from one type of transport within a mode to a different type (e.g., from a medium truck to light trucks) at an intermediate point within the transportation system. This service is normally performed at rail, air, motor transport, and inland waterway terminals by a terminal transfer company.

(1) The terminal transfer company has three platoons, each capable of transferring 300 short tons of noncontainerized cargo per day from one mode to another at a transfer site. The company or its platoons normally operate under the supervision of the mode operator having primary responsibility for operation of the terminal.

(2) The terminal transfer company does not have organic transportation for the onward movement or local distribution of incoming cargo. When such transport is required, it is requested by the terminal transfer company from the local transportation movements offices in accordance with established movements procedures.

(3) Terminal transfer companies are not normally employed at shipping or receiving supply activities. The loading and/or unloading of cargo at such installations are responsibilities of the shipper or receiver.

Section IV. MOVEMENTS MANAGEMENT IN A THEATER OF OPERATIONS

12-15. General

a. Movement management consists of two basic functions: movements control and highway regulation.

(1) Movements control involves the planning, routing, scheduling, and control of personnel and cargo movements over lines of communication (LOC). All movements entering, moving within, or being exported from the theater are included. Of critical importance is the ability to effectively balance and coordinate the capabilities of shipping, transporting, and receiving activities to provide a responsive transportation system.

(2) Highway regulation involves the planning, routing, scheduling, and directing the actual use of the highway network to meet operational requirements. The extent of regulation exercised depends on the amount of movement expected and the capacity of the road network. The types of movements regulated may include convoys, oversize or overweight vehicles, vehicles moving by infiltration, and troop movements by foot. Highway regulation in the corps and division areas is particularly critical due to increased tactical movements on the more restrictive road networks.

b. At the TA level, movement management is the responsibility of the Movement Control Agency (MCA). COSCOM MCC with its Highway Traffic Headquarters (HTH) is tasked with similar responsibilities in the corps area. Within the division, the movement management function is shared by the division transportation officer who works for the G4, and the movement control officer (MCO) who is a member of the division support command (DISCOM) staff.

c. In a multinational environment, movement management functions are performed in accordance with agreed procedures with the host nation and allied stationed forces.

d. Detailed doctrine and procedures relative to transportation movement management is contained in FM 55-10.

12-16. TA Movement Management Operations

a. The TA MCA coordinates and administers theaterwide transportation policy and accomplishes all movement management functions in accordance with policies established by the theater joint transportation board and TA commander. The TA MCA provides and coordinates surface transport in support of all U.S. forces and controls the use of space allocated to the Army for intratheater or intertheater airlift and sealift. Through its HTH, the TA MCA provides centralized control of the time and space on main supply

routes and certain essential feeder routes within the communications zone (COMMZ).

b. The MCA through its planning and day-to-day operations, functions as the nerve center of the entire TA movements control system. As the central movements control organization, the TA MCA: exercises technical supervision over corps MCC operations to ensure overall maximum effectiveness; prepares movement and port clearance plans/programs; and interfaces directly or indirectly with DOD transportation operating agencies; host governments, allied stationed forces, and other theater service activities. Through Transportation Movement Offices (TMO), established on either a regional or critical point basis, the MCA schedules all movements to include departure/arrival times and specific mode(s) of transport.

c. In essence, the TMO is the coordinating link between the MCA, the transportation mode and facility operators, and the users of transportation. They function in an expediting and coordinating role rather than in an operating role. The TMO's principal responsibility is to place requirements of requesting units on transport mode operators.

d. The HTH regulates the use of the COMMZ highway network that is available to U.S. forces. Regulation is normally restricted to the main supply routes and to certain essential routes. Such routes are designated controlled routes and any unit or activity requiring use of the routes must obtain clearance from the HTH. Subordinate highway regulation points are established in the fields to implement the traffic regulation plan as developed by the headquarters. Traffic control in support of the traffic regulation plan is performed by the military police of the host nation.

12-17. Corps Movement Management Operations

a. The COSCOM MCC is responsible for movement management within the corps area. Functions performed are essentially the same as those of the TA MCA but are limited by the echelon of command and geographic area to which assigned and the resources available for employment. The COSCOM MCC is concerned with coordinating movements into, within, and out of the corps rear area and shipments going forward to the divisions. The transportation resources managed are those assigned to the corps. A high degree of coordination between the TA MCA and COSCOM MCC is necessary to effectively regulate the flow of personnel and cargo to and from the corps, regardless of the mode.

b. To assist in accomplishment of the movements control function, the COSCOM MCC establishes Movement Control Teams (MCT) at critical locations throughout the corps area. The functions performed generally parallel those of the TA TMO with primary emphasis being on providing effective transportation support for current operations.

c. Highway regulation within the corps area is the responsibility of the HTH of the COSCOM MCC. The HTH develops the overall plan for highway regulation and establishes highway regulation point teams at critical locations on the road network to carry out the plan. The extent of regulation exercised by the HTH depends on the amount of traffic anticipated and the capacity of the road network. If little movement is anticipated, organizational control may suffice; if heavy movement is foreseen, the HTH must prepare detailed movement instructions.

12-18. Division Movement Management Operations

a. Movement management within the division area is the joint responsibility of the DTO and DISCOM MCO. The DTO coordinates with the division G3 on matters pertaining to tactical troop moves, coordinates with the division G4 on logistical and administrative transport matters, and functions as the communications link between the division and the COSCOM MCC. The DTO also provides the DISCOM MCO with broad policy and planning guidance in regard to movements control. Whatever highway regulation is required within the division is also under the direct auspices of the DTO.

b. Movement control for the division is the responsibility of the DISCOM MCO. In consonance with division established policies and procedures, the MCO controls the commitment of combat service support task vehicles, ensuring that established priorities for movement are followed. The MCO also synchronizes movements of personnel and cargo into, out of, and within the division AO in order to avoid congestion and suboptimization of transportation asset caused by transport equipment accumulating in delivery areas. Included is coordination for combat service support aircraft flights into the division support area and to/from the brigade areas.

12-19. References

a. Army Regulations (AR).

- 55-1 CONEX/MILVAN Equipment Control Utilization and Reporting
- 55-15 Land Transportation Within Areas Outside the Continental United States

- 55-23 Submission or Dry Cargo Requirements and the Assignment and Allocation of Sea Transportation Space
- 55-30 Space Requirements and Performance Reports for Transportation Movements
- 55-36 DOD Use of Domestic Civil Transportation Under Emergency Conditions
- 55-80 Highways for National Defense
- 55-162 Permits for Oversize, Overweight or Other Special Military Movements on Public Highways in the United States
- 55-167 Policy Governing Transportation of Cargo by Military Sea Transportation Service
- 55-355 Military Traffic Management Regulation
- 58-1 Management, Acquisition and Use of Administrative Use Motor Vehicles
- 59-3 Air Transportation Movement of Cargo by Scheduled Military and Commercial Air Transportation—CONUS Outbound
- 59-8 Military Airlift Command Requirements Submissions, Space Assignments, and Allocations and Priorities
- 59-9 Special Assignment Airlift Mission Requirements Submission Procedures
- 59-105 Aerial Ports
- 59-106 Operation of Air Force Terminals
- 700-9 Policies of the Army Logistics System
- b. Field Manuals (FM).*
- 38-704 U.S. Army Materiel Development and Readiness Command Logistics Control Activity and Its Role in Management of the Army's Supply Distribution Pipeline.
- 54-11 Container Movement and Handling in the Theater of Operations
- 55-1 Army Transportation Services in a Theater of Operations
- 55-10 Army Movement Management Units and Procedures
- 55-15 Transportation Reference Data
- 55-20 Army Rail Transport Operations and Units
- 55-30 Army Motor Transport Units and Operations
- 55-40 Army Combat Service Support Air Transport Operations

- 55-50 Army Water Transport Operations
- 55-51 Army Water Transport Units
- 55-60 Army Terminal Operations
- 55-70 Army Transportation Container Operations
- 63-2 Combat Service Support Operations
— Division (How to Support)
- 63-3 Combat Service Support Operations
— Corps (How to Support)
- 100-10 Combat Service Support
- c. DOD Directives and Regulation.*
- 4515.13 Air Transportation Eligibility
- 5160.2 Single-Manager Assignment for Air-lift Services
- 5160.10 Single-Manager Assignment for Ocean Transportation
- 5160.53 Single-Manager Assignment for Military Traffic, Land Transportation, and Common User Ocean Terminals

PART SEVEN: SERVICES

CHAPTER 13

SERVICES MANAGEMENT

Section I. ARMY FOOD PROGRAM

13-1. General

The Army Food Program consists of two distinct subprograms: The Army Food Service Program, established to provide the Army personnel their entitled subsistence, and the Commissary Program, mainly concerned with selling to authorized customers.

13-2. The Army Food Service Program

a. The Army Food Service program, guided by the provisions of the Department of Defense Directive (DODD) 1338.10, covers the entire field of subsistence from acquisition through consumption. It is designed to assist commanders in establishing and maintaining a coordinated plan which will ensure that all authorized persons are properly subsisted in an effective, efficient, and economical manner. Commanders at all echelons are responsible for the implementation and execution of this program.

b. In its broadest sense, the Army Food Service Program encompasses all phases of research and development (R&D), preparation, acquisition, inspection, storage, distribution, nutrition, menu planning, accounting service, and conservation of food, thus, constituting an important element of the logistics system. It involves all matters concerned with the establishment of a food preparation facility, including the design, layout, acquisition, operation, and maintenance of food-related equipment. Also, inherent in the program is the technical training of all personnel concerned with any aspect of Army food.

c. The Deputy Chief of Staff for Logistics (DCSLOG) has Army General Staff responsibility for managing the Army Food Service Program, and is assisted in executing this responsibility by its field operating agency, the U.S. Army Troop Support Agency (TSA). Specific responsibilities and functions of the agency are detailed in AR 10-45, Organization and Functions, U.S. Army Troop Support Agency, Other Department of the Army (DA) Staff, Major Army Commands (MACOM), and installation commanders are outlined in AR 30-1, The Army Food Service Program.

d. The Basic Daily Food Allowance (BDFA) is the monetary value of a prescribed quantity of

food, defined by components from the DOD Food Cost Index, which is required to provide a nutritionally adequate diet for one person for 1 day. The specific policies and procedures for determining the monetary value of the BDFA are contained in AR 30-18.

e. The content of the Army ration is based on the annual food plan and the master menu. The annual food plan is a consolidated listing of all subsistence items to be used during a 12-month period. The plan reflects the unit of issue, the issue quantity, frequency of serving, ration factors, and cost. "The master menu, SB10-260, is the basic guide for providing a variety of nutritionally adequate menus, within the constraints of the BDFA, when the cycle is followed." The master menu is only a guide, however. The Installation Menu Board and the food service sergeant review master menus and may make authorized adjustments dictated by troop desires and local conditions consistent with availability of items at troop issue.

f. Troop Issue Subsistence Activity (TISA):

(1) The TISA is the key element of an installation concerned with acquiring, storing, issuing, selling, and accounting for subsistence supplies required for both consumption by military personnel and for purchase by authorized organizations and activities.

(2) Operation of the TISA involves determination of requirements, requisitioning, receipt, storage, and issue of subsistence. Management principles for these functions discussed in other chapters apply equally to subsistence. However, TISA management personnel must have a thorough knowledge of foods and their preservation qualities to apply the correct principles of storage and issue. TISA operations should be closely coordinated with the Food Adviser. The latter is in a position to advise on estimates, schedules, and issues of subsistence as well as appropriate times to serve operational rations. The Food Adviser can also furnish advice on food preferences and acceptability. He can furnish essential information on menu substitutions, use of excess subsistence and distressed items, retrograde of excess subsistence supplies in unit dining facilities, and expected arrival and departure dates of organizations, thus,

enabling the Troop Issue Subsistence Officer (TISO) to maintain a close control of stock levels and requirements.

g. The Food Adviser is the staff officer who assists the commander in the implementation of the Army Food Service Program. Generally, food advisers are assigned at all levels of command from department level, through Army corps, division, and installation level. They provide commanders, their staff, and food service personnel with the benefit of expert consultation on all technical aspects of the food service program pertaining to garrison and field, food service operations.

h. The Office of the Chief of Engineers (OCE) and TSA have jointly developed standard sketch design documents and/or equipment schedules for the modernization of existing or construction of new facilities. The food service equipment schedules developed for the modernization and new construction programs provide the quantity of equipment authorized for installation in the facility according to the type and size of the facility.

13-3. Resale Commissary Stores

a. DCSLOG is responsible for Army commissaries at Army Staff level, and is the stock fund program director for providing stock fund program and budget guidance.

b. TSA is responsible for commissary operations. The Commander, TSA, has authority for the financial and operational control and central management of Army commissaries worldwide. This re-

sponsibility and authority is administered through a vertical system of organization from Headquarters, TSA to region offices to installation level activities.

c. The commissaries, key elements at installations, are concerned with acquiring, storing, selling, and accounting for subsistence supplies for purchase by authorized customers. They sell subsistence and certain household supplies as authorized in DOD Directive 1330.17 to customers authorized commissary privileges by AR 30-19.

d. The establishment and operation of commissaries are sensitive matters requiring the attention of commanders and logisticians at all levels of command. A commissary will be established/disestablished IAW DODD 1330.17, chapter 5.

e. Commercial operating principles apply to commissaries, except that the profit motive is omitted. Public law provides for commissaries to sell at cost plus a surcharge to cover certain expenses specified in the Annual Appropriation Act. Like its civilian counterpart, the success of any commissary operation is determined by customer satisfaction. Lower prices alone will not necessarily satisfy the average customer. "Management must be trained in modern merchandising techniques, the application of good sanitation practices, personnel management and be thoroughly aware of customer preferences."

f. HQDA will issue specific guidance on emergency use of commissary resale subsistence during emergency situations. Policy guidance is contained within AR 30-19.

Section II. OTHER SUPPORT SERVICES

13-4. Clothing Initial Issue Points (CIIP)

CIIPs are normally established at CONUS installations operating reception stations, at oversea replacement centers, and at Army personnel processing centers. The CIIP provides initial issue of clothing and footwear to individuals entering the Army. The CIIP maintains stocks of complete tariff sizes of clothing and footwear and may stock organizational clothing and individual equipment (OCIE) which normally accompany the enlisted soldier upon transfer. The CIIP also provides alteration services to ensure proper fit of issued clothing (AR 700-84).

13-5. Central Issue Facility (CIF)

A CIF provides the division or installation centralized accountability, issue, stockage, exchange, inspection, and turn-in of organizational clothing

and equipment listed in CTA 50-900. A CIF may be established at installation level in CONUS or the equivalent in oversea commands with major command approval. Only one CIF may be established on an installation.

13-6. Clothing Sales Store

Clothing sales stores are designated facilities at any Army installation where Army uniforms, components, and distinctive officer insignia items are maintained for sale and/or issue to authorized personnel. Clothing sales stores are capable of completing initial issue allowances and, when required, may process individuals for complete initial clothing entitlements. In addition to processing individuals on a cash sales basis, stores are authorized to perform various noncash transactions such as initial issue, gratuitous issues, exchanges, supplemental issues, charge sales, requisitioning special measurement clothing and

footwear, and mail-order service. At the discretion of the installation commander, OCIE items listed in CTA 50-900 may also be sold through stores to permit replacement of lost, damaged, or destroyed Government property for which the individual may be pecuniarily liable.

13-7. Clothing Exchange and Bath (CEB)

The Army provides decontamination, delousing, bath, and emergency clothing reimpregnation service to units in the field. In combat conditions, clothing exchange points will be set up as well as bath operations. These clothing exchange points will provide clean clothes to soldiers as long as organizational clothing is used on a direct exchange basis in accordance with TOE 10-520.

13-8. Laundry and Drycleaning

Army laundry and drycleaning facilities are established primarily to provide service to military personnel, medical facilities, and military organizations. Under garrison conditions, laundry and drycleaning service is provided either by Government-owned fixed facilities or by contract. It is Army policy to make maximum use of commercial facilities. Any new construction, replacement, or reactivation of laundry and drycleaning facilities require prior approval by the Secretary of Defense. At installations where Army fixed facilities are not available, the commander responsible for furnishing these services will either negotiate cross-service agreements with other Government activities, or enter into U.S. Government contracts with commercial laundry and drycleaning firms. The military personnel will pay for laundry and drycleaning service for personal clothing as distinguished from organizational clothing. The costs for processing organizations clothing is borne by the Army. The Army provides laundry service, through the use of mobile units and host nation support, to military units in the field.

13-9. The Army Mortuary Affairs Program

The Army Mortuary Affairs Program is divided into four distinct programs as listed below. These four programs may co-exist.

a. The Current Death Program provides for professional mortuary supplies and related services incident to the disposition of personal effects and remains of persons who are eligible for these services. Under this program, remains are shipped to a place designated by the next-of-kin for permanent disposition and the personal effects are shipped to the legal recipient. This program is operational worldwide during peacetime and may continue in areas of conflict depending on the logistical and tactical situation.

b. The Graves Registration (GRREG) Program provides for search, recovery, initial identification, and evacuation of remains to a mortuary, or temporary burial of deceased personnel in temporary cemeteries. The disposition of personal effects is part of this program. The GRREG program is operational only during a major military conflict when authorized by the responsible Commander.

c. Concurrent Return Program. This program is a combination of the Current Death Program and the GRREG Program, which may exist in an oversea area to support large numbers of military personnel committed to a strategic area; or present in the area to assist in an advisory capacity. It originates with the initial phase of GRREG Program providing search, recovery, and evacuation to a mortuary. It terminates with that phase of the Current Death Program requiring the identification and preparation of remains in a mortuary and shipment to final destination for permanent disposition. The Concurrent Return Program will be placed into effect during emergencies and will continue to exist as conditions and capabilities permit. Upon termination, the program will be phased into the Current Death Program or GRREG Program.

d. The Return of Remains Program would be initiated only on enactment of special legislation. It provides permanent disposition of remains of persons buried in temporary cemeteries if the remains could not be evacuated under the Concurrent Return Program.

NOTE: The Return of Remains Program is being considered for deletion. This program will be incorporated into the Concurrent Return Program.

PART EIGHT: FACILITIES

CHAPTER 14

FACILITIES MANAGEMENT

Section I. REAL PROPERTY PROGRAM MANAGEMENT

14-1. General

a. Real property in the Army's usage is synonymous with real estate and is defined as "land and interests therein, leaseholds, standing timber, permanent buildings, improvements and appurtenances, owned by the United States and under the control of the Department of the Army (DA)" (AR 310-25). Generally, things which are not permanently attached to buildings (such as tools or machinery), and which can be removed without destroying the usefulness of the building, are not considered real property; but the building itself and the ground under it are. Real property includes railroad trackage, roads, paved storage, hard standing and parking areas, utilities systems, fencing, and structures.

b. The Real Property Program management effort can be defined as those management actions to be undertaken by the responsible manager to ensure real property is acquired, developed, and maintained in a manner which is responsive to the mission and is cost-effective, and when no longer needed, disposed of.

c. On an installation level, the Real Property Program is the responsibility of the installation commander. In discharge of this responsibility, the installation commander relies heavily on the Director of Facilities Engineering (DFAE) and the Housing Manager or the Director of Engineering and Housing (DEH) to undertake the actual management of the program. Real Property Program management will, therefore, be looked at in the context of two phases:

- (1) Program Planning.
- (2) Program Development and Execution.

14-2. Program Planning

Program planning consists of those actions taken using detailed methods to satisfy long-range objectives in managing and/or improving real property resources. One tool which is basic to the installation's real property program management planning effort is master planning. Development of Army installations must be accomplished in a manner which will lead to effective fulfillment of the Army's mission at minimal cost. Such development requires a careful appraisal of the many factors which are involved. These factors are not

limited to the installation but may impact other levels of the chain of command as well. Because of the immobility of structures, and hence the long-range implication of construction of facilities with a given design and location, planning associated with construction or alteration of facilities is of special significance.

a. The Installation Master Plan (MP) is a series of documents that present, narrative, tabular and graphic form, the present composition of the installation and the plan for an orderly and comprehensive long-range document to support its assigned missions over a period of approximately 20 years. An Installation Master Plan is prepared initially and then updated every 5 years or as required. It is the responsibility of the installation commander.

b. The Installation Master Plan responds to documents and systems that exist in response to The Army Plan (TAP), such as the force structure components (SACS), the Army Modernization Memorandum and the troop stationing derivative of these systems known as the Army Stationing and Installation Plan (ASIP).

c. The requirements, elements, and specific details of installation master planning are covered in AR 210-20.

14-3. Program Development and Execution

Program development (as compared to program planning) can be defined as the establishment of directives, policies, and implementing procedures necessary for the accomplishment of program objectives; whereas, program execution can be defined as the actions taken to implement the program.

a. The program objectives were defined during program planning (which remains nonetheless a continuing process). Using the program objectives as a basis, specific programs can be developed which will result in the execution and accomplishment of the real property mission.

b. The basic source documents from which Real Property Programs are developed are the Installation Master Plan and AR 420-70, utilization of real estate. The Master Plan describes the installation's short- and long-range requirements. These requirements are compared with current assets,

and the net real property requirements are derived annually as short- (1-year, highest priority) and long-range (greater than 5 years) requirements.

c. Development and execution of real property requirements which include construction are covered in ARs 140-478, 415-15, 415-25, 415-35, 420-10, 420-17, and 700-90. In addition, there are several specific areas relating to Real Property Programs which are covered elsewhere. These include the following subjects:

- (1) Guest and transient housing (AR 210-11).
- (2) Bachelor housing (AR 210-11).
- (3) Training areas and facilities (AR 210-21).
- (4) Family housing (AR 210-6).
- (5) Morale, welfare, and recreational facilities (AR 215-1).
- (6) Laundry facilities (AR 210-130).
- (7) Banking facilities (AR 210-135).
- (8) Military Construction, Army Reserve (MCAR) (AR 140-478).
- (9) Credit Unions (AR 210-24).

14-4. Real Estate Acquisition

In support of the installation's real property mission, in the activation of an installation or in its expansion, it may be necessary for the Army to acquire real estate (real estate is taken, in this context, to mean land and/or facilities). Site selection is basic to the acquisition of real estate. In selecting new sites, it is DA policy to notify the public as early as possible. Even though opposition may develop because of the early release of information, this policy should more often than not result in favorable public relations, general public support of proposed acquisition, and actual assistance in selecting of sites which will fulfill the military requirement and still have the least impact on the civilian economy. This policy will also permit consideration of public preferences in establishment of military facilities, and may prevent "after-the-fact" adverse public reactions.

Section II. REAL PROPERTY MAINTENANCE ACTIVITIES PROGRAM

14-7. General

The Army has a large number of installations of various sizes located in many places around the world. The installation DEH is responsible to the installation commander for engineering, construction, and operation, maintenance, and repair of structures, buildings, grounds, and utilities. Moreover, he supervises fire prevention and protection services plus cultural preservation, fish and wildlife, forestry, custodial, entomology, packing and crating, and refuse handling. In

a. Basic regulatory requirements for real property acquisition are found in AR 405-10. In addition, other areas pertaining to real estate are:

- (1) Real estate agreements with the Air Force (AR 405-5).
- (2) Claims for real estate (AR 405-15).
- (3) Annexation of Federal land (AR 405-25).
- (4) Acquisition of real estate overseas (AR 405-10).

b. Under specific regulatory guidelines, leasing (of land or even facilities) provides an alternative to permanent acquisition or construction. In general, consideration of leasing is dependent on end use, cost, and projected length of use by the Army. AR 405-10 provides the basic guidelines. Other guidance pertaining to family housing is provided in AR 210-50.

14-5. Real Property Disposal

When real property (including facilities) becomes excess to an installation's current or future missions, then the installation initiates action to dispose of it or to inactivate it. Disposition, therefore, becomes an integral part of program planning, development and, often, a part of construction activities (program execution). The basic guidance is provided by ARs 405-90 and 700-90. In addition, specific guidance is provided in the following areas by the indicated regulations:

- a. Granting Use of Real Estate (AR 405-80).
- b. Disposition of structures related to new construction (AR 415-13).
- c. Utilization of Real Estate (AR 405-70).

14-6. Automation

Some facilities management functions are currently being automated in the Army through the Integrated Facilities System (IFS). Its purpose is to provide a system to perform life-cycle management of real properties resources from conception through design, construction, operation, maintenance, and disposal.

order to perform his functions, the DEH has one of the largest work forces of all support organizations on the installation. In addition, the DEH also uses a large number of private sector contractor personnel to perform some specific tasks within his mission. Within the scope of the DEH activities, the largest in terms of committed resources are those connected with real property maintenance activities (RPMA). The RPMA Program is a comprehensive and continuing program encompassing the operation of utilities, the maintenance of real property, minor construction, and other

engineering support. RPMA itself is a collective term for the functional categories of expenses described in the Army Management Structure (AR 37-100 series) and it is primarily financed through the Operation and Maintenance, Army (OMA) appropriation, as well as large amounts of reimbursable funding. The magnitude of the RPMA task can be better understood when it is realized roughly 7 percent of the total Army budget is earmarked for RPMA. Guidance for DEH participation in RPMA is contained in ARs 420-10 and 420-17.

14-8. Management of the RPMA Program

Because of its size, management of the RPMA Program is basic to the success of any DEH operation for two reasons:

a. Effective use of available resources is impossible without formal management containing specific work objectives.

b. Management failures in the RPMA Program:

(1) Become immediately apparent both to customers through lack of needed services and, often, to higher headquarters through installation mission failure.

(2) Can result in reduction of resources because of improper or inefficient use.

c. There are four basic elements used in the DEH RPMA Management Program. These are:

(1) The Resource Management Plan (RMP).

(2) Unconstrained Requirements Report (URR).

(3) The Annual Work Plan (AWP).

(4) Backlog of Maintenance and Repair (BMAR).

d. Each of these management devices is addressed below:

(1) *The RMP*. The RMP addresses all known DEH requirements in lay terms and is a basis for formulating the URR and the AWP. The RMP serves as a single-source reference of required management information. It is also useful in formulating installation input to various budget submissions. The plan is a current-type document; maintained in such a format it can be easily changed whenever any funding change affects a portion of the plan. Guidance preparation is contained in AR 420-17 and DA Pam 420-6.

(2) *The URR*. The purpose of developing a statement of unconstrained requirements is to establish a listing of both the RPMA total work requirements (in dollars) and the funds needed to provide all the resources required for accomplishment of the entire RPMA mission. This includes funds for RPMA work done both in-house and by contract. Since this listing is characterized as "unconstrained," it is developed without regard to prior funding and performance, available manpower, manpower ceilings, unavailabil-

ity of other resources, or similar constraints. Thus, it is a consolidation of total obligations, actual and estimated, from all appropriations except Family Housing used for accomplishment of the RPMA mission. Guidance for preparation of the URR is found in AR 420-16.

(3) *Annual Work Planning*. A major management function in any organization is resource allocation. The primary tool available to the DEH to allocate his available RPMA resources is the AWP, prepared in accordance with DA Pam 420-6. For the purposes of the AWP, the work which must be done is defined in the financed portion of the URR. The resources allocated are financial. The plan covers 1 fiscal year, and is prepared about 6 months prior to the start of the fiscal year.

(4) *BMAR*. BMAR is the end of fiscal year measurement of maintenance and repair work which remains unfinanced from the year in which work was programmed for accomplishment. Although BMAR is reported only as an end-of-year measurement of unfinanced requirements, it should be understood that the unconstrained listing for an installation, from which the BMAR report is derived, is a dynamic listing that is continually being revised because of factors such as changes in priorities, emergency requirements, demolition of facilities, and availability of funds. During the course of the year, BMAR projects compete with other unconstrained requirements for availability of funds. Additionally, new requirements are constantly being identified which have potential to become BMAR because of lack of resources. Consequently, the amount of BMAR and the list of specific BMAR projects will change from year to year. New BMAR must have been scheduled for accomplishment on the Annual Work Plan during the fiscal year. Within the Family Housing area, this same measure is referred to as "Deferred Maintenance and Repair (DMAR)."

14-9. References

In addition to the references quoted in the body of this chapter, the following publications pertain to RPMA as shown:

- a. *Army Regulations (AR)*.
- | | |
|-----------|---|
| 11-27 | Army Energy Program |
| 37-100-XX | The Army Management Structure (AMS) Appropriations and Funds Available for Obligations Expense and Expenditures (FY XX) |
| 40-5 | Health and Environment |
| 140-478 | Reserve Component Facilities |
| 200-1 | Environmental Protection and Enhancement |
| 200-10 | Army Environmental Program |
| 210-17 | Inactivation of Installation Facilities |

210-24	Credit Unions	420-53	Refrigeration
210-50	Family Housing Management	420-54	Air-Conditioning, Evaporative Cooling Dehumidification, and Mechanical Ventilation
290-5	Army National Cemeteries		
385-60	Coordination With Department of Defense Explosives Safety Board	420-55	Food Service and Related Equipment
405-45	Inventory Army Military Real Property	420-70	Building and Structures
405-90	Disposal of Real Estate	420-72	Surfaced Areas, Railroads, and Associated Structures
415-2	Department of Defense Construction Criteria	420-74	Natural Resources: Land, Forest, and Wildlife Management
415-10	Military Construction, General	420-76	Pest Management Program
415-25	Facilities for RDTE	420-81	Custodial Services
415-28	Department of the Army Facility Classes and Construction Categories	420-83	Maintenance and Services (M&S) Equipment and Facilities Engineering Shops
415-35	Minor Construction	420-90	Fire Protection
415-50	Basic Facilities and Space Criteria for Construction at U.S. Installations in Event of Emergency	700-9	Policies of the Army Logistics System
		700-900	Army Industrial Preparedness Program
420-15	Certification of Utility Plant Operators and Personnel Performing Inspection and Testing of Vertical Lift Devices	700-112	Relocatable Buildings
		700-126	Basic Functional Structure
		702-7	Reporting and Product Quality Deficiencies Across Component Lines
420-16	Facilities Engineering Reports	750-1	Army Materiel Maintenance Concepts and Policies
420-17	Real Property and Resource Management		
420-22	Preventive Maintenance and Self-Help Programs	<i>b. Technical Bulletin (TB).</i>	
420-41	Utilities Contracts	420	Engineered Performance Standards
420-43	Electric Services	<i>c. Technical Manuals (TM).</i>	
420-46	Water and Sewage	5-600	Series Repair and Maintenance Procedures Criteria
420-47	Solid and Hazardous Waste Management	5-800	Series Construction Criteria and Design Requirements
420-49	Heating, Energy Selection and Fuel Storage, Distribution, and Dispensing Systems	<i>d. DA Pamphlet.</i>	
		420-6	Resources Management System

PART NINE: OTHER LOGISTICS SERVICES

CHAPTER 15

SECURITY ASSISTANCE

15-1. General

The global military strategy of the United States since the end of World War II, particularly in the limited war area, has always assumed the availability of allied forces. This kind of collective security is based on a strong and coordinated common defense posture. Originally, military assistance to allied and free countries having the will but not the means to share in the common defense was a major instrument of U.S. foreign policy. While the basis for our military assistance has remained firm, the proportions of how to provide it have varied among programs for foreign military sales (FMS), and mutual research and development (R&D) programs. All of these programs impact on the Army logistics system, competing for resources and demanding the specific attention of individual managers. Moreover, all proposed commitments for the delivery of materiel to friendly foreign nations must be evaluated to be sure they have been carefully coordinated with U.S. requirements and can be met within the proposed time period.

15-2. Military Assistance Legislation

a. The legislation for foreign assistance provides the legal basis for agreements between the United States and friendly foreign countries. International agreements may consist of either a treaty between two or more nations, or an executive agreement between a designated representative of the President and the Foreign Minister of the country concerned. The treaties are of a more formal nature and require ratification by the Senate. However, each represents a contract between parties involved, comprises a matter of record of the agreement, and specifies in detail the particular terms, duration, and provisions of the agreement. The mutual defense obligations of the United States are worldwide.

b. The transfer of military assistance to eligible foreign countries under authorizing legislation is called security assistance (SA).

(1) Security assistance is defined as, "a group of programs which authorize the United States to provide defense articles, military training, and other defense-related services, by grant and by credit or cash sales, in furtherance of our national policies and objectives." These programs are authorized by the Foreign Assistance Act of 1961, as

amended, and the Arms Export Control Act of 1976, as amended.

(2) The term "security assistance" (SA) is comprehensive and encompasses support in the form of design and development, acquisition, storage, transportation, distribution, maintenance, evacuation, and disposition of materiel. It includes the provision of whether the logistics support is rendered on a reimbursable or nonreimbursable basis.

(3) A variety of means is employed in planning, developing, and administering SA support to eligible countries. Current legislation continues to grant to the President the general authority for providing SA. It authorizes him to acquire defense articles and services from any source and to provide this support by grant, loan, or sale. The actual provision of defense materiel, services, and training is administered under one of the following SA programs:

(a) Military Assistance Program (MAP). Defense articles and services provided to eligible recipient countries on a grant basis (Foreign Assistance Act of 1961, as amended).

(b) International Military Education and Training (IMET). Military training provided to selected foreign personnel on a grant basis (Foreign Assistance Act of 1961, as amended).

(c) Foreign Military Sales (FMS). The portion of the United States SA which authorizes the United States to transfer defense articles, services, or training to foreign countries on a reimbursable basis (Arms Export Control Act of 1976 as amended). This differs from the MAP which is furnished on a nonreimbursable basis.

15-3. Responsibilities for SA

a. The President. In the basic foreign assistance legislation and its amendments, Congress holds the President responsible as the ultimate coordinating authority for development, implementation, and execution of the foreign assistance program. By Executive order, the President delegates to the Secretary of Defense and Secretary of State those SA functions not reserved to the President. The President monitors closely the respective portions of the SA programs executed by the Secretary of State and the Secretary of Defense. Typical areas of decision which must be resolved in the process of program development are:

- (1) Countries or regions to receive assistance.
- (2) Magnitude of aid, within limits set by law.
- (3) Type of equipment, materiel, or supplies to be provided.
- (4) Type of financing to be employed such as grant aid, credit payment, and cash sale.

b. The Secretary of State. Under the direction of the President, the Secretary of State is responsible for the continuous supervision and general direction of economic, military assistance, grant aid, and FMS programs, including the determination of whether a country shall receive SA, the value thereof, and the coordination of such programs to ensure they are effectively integrated and the foreign policy of the United States is best served thereby. This function has been delegated to the Under Secretary of State for Security Assistance.

c. The Secretary of Defense.

(1) Under the direction of the President, the Secretary of Defense is responsible for:

- (a) Determination of military equipment requirements.
- (b) Procurement of military equipment consistent with the programs of the military departments.
- (c) Supervision of end item use by recipient countries (grant aid).
- (d) Supervision of training of foreign military personnel.
- (e) Movement and delivery of military equipment.
- (f) Establishment of priorities in procurement, delivery, and allocation of military equipment.

(2) The Secretary of Defense has delegated to the Under Secretary of Defense (Policy) (USDP) the authority to act in his name in regard to all matters pertaining to SA. The USDP delegates responsibility for execution of approved SA programs to the Director, Defense Security Assistance Agency (DSAA) and has assistant Secretaries with regional responsibilities who work with the Director, DSAA on regional SA policy matters and budget development.

d. The Secretary of the Army.

(1) In matters of SA, the Department of the Army (DA), like the other military departments, participates in the development, negotiation, and execution of agreements with foreign governments. In addition, each of the military departments provides the means and the act of execution of the SA programs. Each military department and the Defense Logistics Agency (DLA) acts as the responsible source of technical data regarding price, source, availability, and leadtime of items of mate-

riel which are the logistics responsibility of the department or agency.

(2) The Under Secretary of the Army acts for the Secretary of the Army in security assistance matters. The Assistant Secretary of the Army (Research Development and Acquisition) (ASA(RDA)) implements approved security assistance policy at the Secretariat level. The Deputy Chief of Staff for Logistics (DCSLOG) coordinates development and issuance of Armywide security assistance programs with the Army Staff. The Assistant Deputy Chief of Staff is the Army focal point for SA matters and the Army spokesman for SA matters exercising staff supervision over the SA program for the ASA (RDA).

e. The Army Materiel Command (AMC).

(1) The Commander, AMC, is the DA executive agent for SA acting on behalf of DA for matters pertaining to the operational aspects of approved FMS and MAP programs. Operational matters include all matters pertaining to the development, execution, administration, and management of approved FMS cases, and execution, administration, and management of MAP orders. As executive agent, Commander, AMC, is authorized direct communication with the ADCSLOG (SA) and cognizant DA staff element(s).

(2) The logistics responsibilities of the Commander, AMC, to support the SA program are compatible with the wholesale logistics support responsibilities for the United States force structure.

(3) The Commander, AMC discharges the executive agent SA mission primarily through the Commander, U.S. Army Security Affairs Command (USASAC). As Army executive agent for SA matters, interacts directly with DSAA and tasks as appropriate other major Army commands (MACOMs) and field activities to fulfill approved program commitments.

f. USASAC. USASAC performs for AMC the execution of SA programs and is the Army single focal point for interface of SA activities with U.S. defense and Government agencies, foreign governments, and U.S. and foreign industry. The management functions are executed by USASAC, AMSAC-M, located at Alexandria, VA. The operational functions are executed by USASAC, AMSAC-O, located at the New Cumberland Army Depot.

g. Training and Doctrine Command (TRADOC). DA has assigned overall responsibility for management of the Security Assistance Training Program (SATP) to TRADOC. Within TRADOC, the Security Assistance Field Activity (SATFA) manages CONUS resourced training, and the Security As-

sistance Training Management Office (SATMO) directs exported training.

15-4. SA Management

Additional information concerning organization, policies, and execution techniques is contained in DOD 5105.38-M, Security Assistance Management

Manual; AR 12-1, Security Assistance—Policy and Responsibilities; AR 12-2, Executive Agent Designation for Selected Army Security Assistance Functions/Activities; AR 12-8, Foreign Military Sales Operations/Procedures; and AR 12-10, Military Assistance Grant Aid Operations and Procedures, and AR 12-15, Joint Security Assistance Training.

CHAPTER 16

MANAGEMENT OF EXCESS AND SURPLUS PROPERTY

Section I. THE DEFENSE PERSONAL PROPERTY UTILIZATION AND DISPOSAL PROGRAM

16-1. General

a. Logistics managers must constantly face the task of balancing supply and demand. This task becomes more critical in times of war as enemy actions affect requirements for most items of supply in ways that are difficult to predict. Even if it were possible to predict the precise time a war would end, there would probably be excesses of some items of supply due to such factors as obsolescence, miscalculations, and overly conservative safety levels. Despite the inevitability of excesses, good management practices can reduce the magnitude and increase the economic return through utilization or disposal actions.

b. An understanding of the distinction between excess and surplus property is essential to this discussion. Excess property is the quantity of property in possession of any component of the Department of Defense (DOD) which exceeds the quantity required or authorized for retention by the component. Surplus property is the excess property which has been screened and been determined not required for the needs or responsibilities of any Federal agency. The screening is conducted by DOD and the General Services Administration (GSA).

16-2. Objectives

a. The prime objective of the overall Defense Personal Property Utilization and Disposal Program is to ensure effective utilization, conservation, and marketing of Government-owned property (including scrap). Specific objectives are to—

(1) Promote maximum utilization of excess, surplus and foreign excess personal property.

(2) Permit authorized donation of surplus property.

(3) Obtain optimum monetary return to the Government for property sold.

(4) Preclude unnecessary abandonment or destruction of surplus materials.

(5) Promote the cost-effective recovery of precious metals from surplus precious metal-bearing materials.

(6) Conserve the Nation's resources, particularly critical and strategic material.

(7) Dispose of hazardous material/waste in an environmentally acceptable manner.

(8) Promote the DOD Resource Recyclable Material Program.

b. To achieve these objectives, disposal programs should be developed with regard to other logistics programs such as: research and development (R&D); inventory management; distribution management; maintenance management; procurement; and production management. In addition, introduction of new principal items of materiel will normally result in similar items being declared obsolete. Planning for the gradual phaseout of materiel being replaced is essential to preclude large quantities of excess.

16-3. Authority and Responsibilities

a. The Federal Property and Administrative Services Act of 1949 (Public Law 152, 81st Congress), as amended, assigned responsibility for the overall supervision and direction over the disposition of excess and surplus property to the Administrator of GSA. The act further assigned the responsibility for supervision and direction over the disposition of DOD foreign excess property to the Secretary of Defense. The Administrator of GSA has delegated to the Secretary of Defense the responsibility for the disposition of excess and surplus property generated by DOD.

b. The Director, Defense Logistics Agency (DLA) operating under the overall policy guidance of the Assistant Secretary of Defense (Production and Logistics (P&L) administers the Defense Personal Property Reutilization and Disposal Program and the Defense Precious Metals Recovery Program worldwide. Accordingly, Headquarters, DLA is responsible for the development of policies relating to these programs and the development of systems, techniques, and procedures as may be appropriate.

c. The Secretary of Defense has assigned the military services responsibility for—

(1) Recommending policy and procedural changes, and participating in decisionmaking processes pertaining to the Defense Personal Property Reutilization and Disposal Program and the Defense Precious Metals Recovery Program, which affect the military services, to the Director, DLA, for appropriate action.

(2) Providing assistance to the Director, DLA, upon request, in the resolution of mutual problems within the Defense Personal Property Reutiliza-

tion and Disposal Program and the Defense Precious Metals Recovery Program.

(3) Furnishing to the Director, DLA mutually agreed upon data necessary to effectively administer the Defense Personal Property Reutilization and Disposal Program and the Defense Precious Metals Recovery Program.

(4) Promoting maximum utilization of supply system stocks, excess, surplus, and foreign excess personal property and refined precious metals for internal use or as GFM.

(5) Nominating schools or organizations in the VI, American Samoa, Guam and TTPI to the ASD (P&L) for special interest consideration as Service Educational Activities.

(6) Providing support to tenanted Defense Reutilization and Marketing Regional Offices and Defense Reutilization and Marketing Offices (DRMO); and their offsite branches, in consonance with applicable interservice support agreements.

(7) Accomplishing the disposal of property not authorized for transfer to a disposal account.

(8) Participating in the Precious Metals Recovery Program (PMRP) to the maximum extent.

(9) Conducting property utilization and disposal courses (Army only).

(10) Administering reclamation programs and accomplishing reclamation of, as appropriate, required items from excess materiel.

(11) Storing and reclaiming excess complete aircraft (Air Force only).

(12) Administering the reclamation and removal of equipment and repair parts from stricken naval vessels (Navy only).

(13) Establishing and administering disposal accounts, as jointly agreed to by DLA and the military services, to reclamation functions to be accomplished by the military services.

(14) Reporting surplus merchant vessels or vessels of 1500 gross tons or more, capable of conversion to merchant use to the Office of Administrative Services, Maritime Administration, U.S. Department of Transportation.

(15) Establishing the program and directing operations related to lumber and timber products.

d. To carry out its responsibilities in relation to excess and surplus personal property, the DLA established the Defense Property Disposal Service (DPDS) as its primary field activity to perform program management and staff supervision of the Defense Personal Property Disposal Program, consisting of five Defense Property Disposal Regions (DPDR) and assigned to the DPDRs are the DPDOs worldwide.

16-4. Excess Declaration and Reporting

a. The logistics manager constantly faces the task of purging the inventory of stocks which are excess to current needs or foreseeable requirements. Realizing it is costly to maintain an inventory larger than needed to support using units, supply managers at all levels must determine what portions of stock in long supply (i.e., in excess of the quantity authorized or required to be on hand) can be economically retained for future use or, conversely, reported as excess. It should be emphasized that the supply manager is concerned with materiel in the possession of using units as well as stocks on hand in supply installations, particularly materiel which must be reported to the appropriate materiel management center overseas or national level inventory control point (ICP) within the Continental United States (CONUS) for disposition instructions when no longer needed by the user.

b. Management tools are available to the supply manager to assist in predicting excesses. For certain classes of supply, excesses can be predicted by an economic retention formula which shows at what period the cost of retaining an item is equal to the cost of disposing of it and reprocurring it at a later date. Retention costs include such elements as cost of storage space, care and preservation, cost of issue, transportation, deterioration, and obsolescence. In addition to cost factors, consideration should be given to future utility and essentiality of the item, the effect of retention on procurement or more modern materiel, and the capability of procurement and procurement leadtimes. Although the same elements are considered to varying degrees, a formalized economic retention formula is seldom used with high-value items but is normally associated with low-value items of materiel. The capital investment takes on added importance as the unit of value of the item increases.

16-5. Reporting Channels in CONUS

a. As a rule, excess property in the hands of units at CONUS installations is reported to the accountable officer serving the activity. Excess property of CONUS installations will be reported by the accountable officer to the appropriate ICP for disposition instructions. However, automatic return items (ARI) (see AR 710-1), serviceable or unserviceable, that became excess to local requirements are to be shipped to the appropriate storage depot automatically and not reported under the materiel returns program. Excess property will be

reported in accordance with procedures outlined in AR 725-50. When it is determined reported excess property is needed for depot stocks, the ICP sends a reply to report of excess, showing the depot to which the excess property is to be shipped.

b. Upon receipt of reports of excess, the ICP screens items to determine if the excesses can be used to full outstanding requisitions or are needed for depot stocks. Appropriate disposition instructions should be provided the reporting installation as expeditiously as possible, since retention cost could soon exceed potential savings from use of some items of materiel.

c. When the ICP determines the reported property is excess to the needs of the Army, the reporting accountable officer will be instructed to transfer the property to the DRMO. Major commands should promptly review listings of excess

which are to be transferred to the property disposal office to determine if use within the command is warranted. Delay of such review could lead to excessive administrative work and unnecessary physical movement.

16-6. Reporting Channels in Oversea Theaters

a. In the overseas theaters, it is important that excess and disposal operations be closely tied to both maintenance and supply operations. A large amount of excess property overseas is generated through maintenance operations and, conversely, proper management of excess property will reduce the maintenance workload. Since the primary objective of any disposal program is maximum use, overseas supply

managers must have knowledge of disposal programs at all levels, since they can serve as a source of supply. Hence, each reviewing echelon in the operating chain compares excess listings with known and anticipated requirements to preclude unnecessary backhaul or new procurements.

b. Using units in the forward areas of active theaters normally turn in excess property to supporting direct support (DS) or general support (GS) units as prescribed by theater regulations. Maximum use will be enhanced by prescribing that the excess property be returned through the supplying unit prior to actual movement whenever the tactical situation will permit. This increases the probability of lateral use while decreasing expensive backhaul and multiple handling. Property which is excess to the needs of the DS and GS units is reported to the appropriate theater materiel management center.

c. In the rear areas of oversea theaters, collection and classification companies generate large amounts of potential excess property through their recovery and cannibalization programs. Such property is reported through the materiel management centers for disposition instructions.

d. Property disposal companies operate in support of theater Army or corps to provide for receipt, final classification, temporary storage, preparation for, and disposal of usable materiel, scrap, and waste. Normally, such units are not in the reporting channel for excess property, but may be used for temporary

storage of excess property awaiting disposition instructions.

e. As a general rule, excess property located in oversea theaters will be reported by oversea inventory control centers to the appropriate national inventory control point (NICP) for disposition instructions. Experience has shown that the cost incurred in reporting excess property of lower value generally will exceed the return. NICP screening of excess reports from oversea theaters is similar to that described above for CONUS installation excess reports. However, since potential savings in transportation costs are quite significant, more emphasis is given to lateral redistribution among theaters. Once the national inventory control manager determines the property is excess to the requirements, the oversea commander is directed to transfer the property to the appropriate disposal officer.

1-7. Screening of Excess Property

It is DOD policy to encourage all military services and DOD agencies to use available materiel in lieu of new procurements. At this time, the excess materiel is still in the item manager's account. When an item manager decides the materiel is no longer required within the service, the item manager directs transfer to the DPDO which screens the materiel for other service or agency use after it is picked up on the DPDO accounting system. This process is described in DOD 4160.21-M, Defense Utilization and Disposal Manual.

Section II. TRANSFER OF EXCESS PROPERTY

16-8. Transfer Among Military and Civilian Federal Agencies

a. For reasons of economy, administrative procedures for transferring excess property should be streamlined as much as possible. However, property accountability must be maintained throughout the screening and transfer process.

b. When an Army activity determines that property on a DPDS excess listing is required, it submits a request to DPDS by telephone, message, or letter. DPDS does not physically have possession of excess property, but will allocate the property to the requester if available; consequently, requisition forms are not used for this purpose. It is the responsibility of the requesting agency to ensure requests are restricted to those categories of property which are authorized by appropriate documents.

c. Upon receipt of the request, DPDS either confirms availability or advises the requesting activity the materiel is no longer available, or advises availability must be established with the GSA regional office hold-

ing redistribution control.

d. Military screening activities should make every effort to submit requests for materiel undergoing consecutive screening prior to the military priority date to prevent the necessity for subsequently requesting allocation of the materiel from the GSA regional office.

e. When Army activities have requirements for excess property which has been reported through DPDS to a GSA regional office for screening and is under the redistribution control of GSA, they submit requisitions to the appropriate GSA regional office.

f. Army activities may also acquire excess civilian Federal agency property offered by GSA regional offices. Requests for transfer of civilian Federal agency excess property are submitted to the GSA regional office having redistribution control of the property and are restricted to those categories of property which the requesting activity is authorized to acquire.

g. Nonappropriated fund activities may requisition excess property through servicing accountable supply officers or directly from DPDS. The type of property, either reportable or nonreportable, to be transferred is limited to property which will be used for purposes from which no direct benefit will be realized by individuals. When such property becomes excess to the needs of the nonappropriated fund activity, it is turned over to a DOD disposal activity. Proceeds realized from the sale of such property are credited to the General Fund, U.S. Treasury — not to the nonappropriated fund activity reporting the property for disposition.

16-9. Transfer to Foreign Governments

a. Transfers to DOD excess property may be made to foreign governments designated by the Department of State as eligible to purchase property under the Foreign Military Sales Act, PL 90-629. As part of the central screening operation, DPDS distributes listings of available excess property to these eligible foreign governments. These listings are based on information furnished by each government as to type of property they desire to screen against requirements. This screening is accomplished concurrently with screening by U.S. DOD activities; however, it cannot be released for sale until screening is completed.

b. Requests for availability are submitted by eligible foreign governments directly to DPDS for the necessary approval (including State Department clearance, if required), for firm determination of availability of property involved, and for action to establish or verify the transfer price.

CHAPTER 17 HEALTH SERVICES LOGISTICS

Section I. INTRODUCTION

17-1. General

a. Health Service Logistics is an essential element supporting the overall patient care and treatment mission. The functions inherent in the health service support mission include outpatient medical care, outpatient dental care, optical services, patient evacuation and medical regulating, hospitalization, blood bank services, laboratory services, preventive medicine, veterinary services, medical materiel and maintenance, optical fabrication, professional consultation of various medical and surgical specialties, and the capability to reconstitute corps health service elements.

b. The health services logistics system is an integral part of the Army logistics system. While complying with the AR 700-series regulations, Army Regulation 40-61 sets forth Medical Materiel policy and procedures in management of this unique commodity. The rationale for a health services logistics system is based on the following criteria: Maintaining the health and welfare of soldiers and their dependents is a critical mission of the Army Medical Department (AMEDD).

As the sole provider of health care, The Surgeon General (TSG) controls the resources to accomplish his health and welfare mission. Medical materiel management is a resource of The Surgeon General to accomplish his health and welfare mission. Medical materiel generally has no application beyond the care and treatment of patients.

"c. Medical Materiel is identified as Supply Class VIII and is managed by health care logistics officers to support the functions and criteria discussed above. It includes medical supplies, medical equipment and medical repair parts. Medical Materiel has unique characteristics which affect its acquisition, management, storage. . . . calibration support. In order to provide quality patient care and obtain essential materiel in a field of rapidly changing technology, the AMEDD's health services logistics system relies heavily on the use of non-standard medical materiel procurement."

Section II. THEATER OF OPERATIONS

17-2. Health Services Organization and Functions

a. Health services logistics must include, in the overall plan, in-theater medical maintenance, optical fabrication, medical supply, oxygen generation, and medical grade water production. The intense management of all aspects of health services logistics within the theater is essential and requires organic command and control to provide overall operational standardization, maintenance, and logistical support.

b. Logistics planning is required to adequately support combat operations. Requirements may change as the theater matures. During the initial phases of conflict in a mature theater, resupply will be effected from war reserve stockpiles and in the case of developing theater via Initial Preplanned Supply Support (IPSS). Follow-on resupply beyond war reserve levels will also be included in IPSS and identified in LOGPLANS to ensure continued resupply until normal requisitioning procedures are established. Medical resupply planning has to consider existing in-theater health services logistics organizations or deploying organizations tasked with a supply support mission. Resupply/throughput will normally be limited to CORPS level medical units (i.e., MEDSOM Battalion or major medical unit). Un-

der exceptional conditions, resupply/throughput may be required directly to the Division until CORPS medical units arrive.

c. Throughput of medical supplies will continue on an exception basis for duration of the conflict. These throughput medical supplies will be delivered by supporting transportation assets directly to the Corps MEDSOM Battalion or as specified in the appropriate LOGPLAN.

d. Provisions of the Geneva Convention must be considered when choosing locations for health logistics units and accomplishing the distribution of class VIII supply. The Geneva Convention requires medical materiel be stored and distributed separately from other classes of supply in order to be considered protected by its provisions. Provisions of the Geneva Convention preclude willful destruction of medical materiel when capture by enemy forces is imminent. Medical supplies confiscated and captured from the enemy are turned over to medical supply activities, but cannot be used for treatment of U.S. personnel until it has been inspected by competent medical personnel and approved by the command surgeon.

e. With certain restrictions, specified items and categories of items of medical supply are authorized for procurement locally within the theater. Procurement of certain medical supplies from non-United States sources in oversea areas is not authorized unless specific prior approval of The Surgeon General (TSG) is obtained.

f. Storage facilities for Class VIII supply must provide 100-percent covered storage whenever possible. Existing buildings should be utilized to the greatest extent possible, to provide adequately covered, refrigerated, secured, and controlled humidity and temperature storage.

17-3. Operational Concept

a. Deployment.

(1) *Mature Theater.* In-theater medical units and deploying medical units sustain their operations with unit basic loads and are resupplied from in-theater war reserve stockpiles. Resupply to the theater is preplanned and defined in appropriate LOGPLANS. This preplanned resupply includes shortfalls to existing war reserves, follow-on resupply, and buildup to approved theater stockage levels and combat loss replacements. In-theater health services logistics units (MEDSOM BNS) operate from stockpiles of war reserves and receive resupply from CON US via preplanned supply increments or normal requisitioning procedures.

(2) *Developing/Bare Base Theater.* In the initial stages of a developing theater, arriving medical units to include MEDSOM Battalions will operate from their preplanned basic loads and from any existing prepositioned war reserve stockpiles. Initial resupply for deploying medical units may consist of preconfigured medical supply packages tailored to meet mission requirements. This level of preplanning beyond organic capability must be directly coordinated with the supporting MEDSOM Battalion. This resupply by preconfigured packages is intended to provide support during the initial phase until line item requisition is established to the MEDSOM Battalion. This provision of preconfigured packages may continue on an exception basis when dictated by operational needs. This package preconfiguration will be accomplished at the supporting MEDSOM Battalion.

b. Organizations for Medical Materiel Support.

(1) The COMMZ MEDSOM Battalions are assigned to the Medical Command (MEDCOM), under the command and control of the Medical Logistics Control Group (MLCG). They are allocated on the basis of one per Corps supported. Major customers include field, station, and general hospitals located in the COMMZ. The COMMZ MEDSOM has the dual mission of providing health services logistics support to med-

ical units located in the COMMZ as well as providing support to the Corps MEDSOM Battalion. The COMMZ MEDSOM Battalion is a storage site for the MLCG and performs the functions of receipt, storage and shipment of Class VIII materiel, bio-medical equipment maintenance, oxygen generation, medical grade water production, single and multivision optical fabrication and backup inventory management for the MLCG. Resupply of the COMMZ MEDSOM Battalion is normally from CONUS sources through Medical Air Lines of Communications (MEDALOC).

(2) The Corps MEDSOM Battalion or Combat Zone (CZ) MEDSOM Battalion is under the command and control of the Medical Brigade/Medical Group of the Corps. The CZ MEDSOM Battalion provides area support to medical and non-medical units operating within its Corps boundary and is allocated on the basis of one per four divisions or equivalent supported. Major customers of the CZ MEDSOM Battalion include divisions, Combat Support Hospitals (CSH), Mobile Army Surgical Hospitals (MASH), Evacuation (EVAC) hospitals, and an area medical laboratory. The CZ MEDSOM Battalion performs the following functions: receipt, storage and issue of medical materiel; bio-medical equipment maintenance; single vision optical fabrication services; and oxygen generation and medical grade water production. Resupply of the CZ MEDSOM Battalion is from the COMMZ MEDSOM Battalion or direct throughput shipments from CONUS.

(3) The supply and services division of hospitals located in the Corps area stock approximately 10-15 days of Class VIII supply. The supply and service division of hospitals provides medical resupply support to hospital activities and may be tasked to provide area support for Class VIII supply to medical and nonmedical units. The supply service division also provides medical equipment maintenance support to hospital activities.

(4) The Division Medical Supply Officer (DMSO) of the Medical Battalion stocks 10-15 days of supply authorized in the division level medical resupply set and provides Class VIII supply and medical maintenance support to all units assigned or attached to the division. DMSO receives resupply support and bio-medical maintenance support from the CZ MEDSOM Battalion.

c. *Theater Inventory Management.* The MLCG is assigned to the Theater Army MEDCOM on the basis of one per theater. The MLCG is the theater Class VIII inventory control point and performs centralized theater Army level medical materiel, optical, and bio-medical maintenance management functions. In the event an MLCG is not employed, an augmented COMMZ MEDSOM will perform the theater level management

functions of the MLCG.

d. Requisition Flow. Within a division, informal requests from battalion aid stations are submitted by the most expeditious means available to supporting clearing stations of the medical battalion. Clearing stations submit formal requisitions to the DMSO. Requisitions for medical materiel flow from divisional and Corps level medical units to the Corps MEDSOM Battalion for issue. The Corps MEDSOM Battalion either issues the item from stock or passes the requisition to the MLCG. The MLCG, either directs a COMMZ MEDSOM Battalion to fill the requisition or further passes the requisition to a CONUS source. Replenishment requisitions for Corps MEDSOM Battalion stocks follow the same procedure described above. Requisitions that are passed to CONUS sources are normally filled via throughput directly to the requisitioning MEDSOM Battalion, with those designated for Corps MEDSOM Battalions not normally transshipped through a COMMZ Battalion. The MLCG submits replenishment requisitions to CONUS for the COMMZ MEDSOM Battalions.

e. Flow of Material. Medical materiel is shipped from CONUS through the theater airhead/port directly to the COMMZ or Corps MEDSOM Battalion and ultimately to supported Corps and COMMZ medical units via COMMZ/CORPS transportation assets. Medical supplies for the division will flow to the division medical supply office (DMSO). Supply point distribution is used to move the medical supplies forward to the medical companies in the brigade support area. From this point, medical supplies are carried forward using ground or air ambulances or other vehicles that are going forward to the battalion aid stations to evacuate patients (BACK-HAUL). The implementation/extension of the palletized loading system (PLS) may result in unit distribution in lieu of supply point distribution.

f. Automated Systems. An organic ADP system at the MLCG, COMMZ MEDSOM Battalion and Corps MEDSOM Battalion will satisfy operational requirements. The ADP system for the MLCG will have the capability to perform theater level inventory management functions. Additionally, the COMMZ MEDSOM Battalion's automated system provides the alternate management record site for the MLCG. In those instances when the MLCG is co-located with one of the

COMMZ MEDSOM Battalions, the alternate management record site will be located at another COMMZ MEDSOM Battalion that is geographically separated from MLCG. ADP subsystems in the Division and each COMMZ and Corps medical unit will allow users to electronically transmit medical supply transactions to the supporting MEDSOM Battalion in the Corps or to the MLCG in the COMMZ.

17-4. Medical Maintenance and Optical Support

a. All hospital units operating in the CZ and COMMZ have organic biomedical maintenance capability as does the Division Medical Battalions. All biomedical maintenance performed in the theater will conform to the three level maintenance concept. Biomedical maintenance performed at the Corps MRDSOM will be intermediate direct support and will concentrate on repair and return, employ contact teams, and maintain a limited float of critical items. The COMMZ MEDSOM Battalion will provide biochemical maintenance support to the medical units in the COMMZ and backup support to the Corps MEDSOM Battalions. The COMMZ MEDSOM will provide Intermediate direct support, intermediate general support and depot level medical maintenance and will concentrate on repair and return to stock for the Corps and repair and return to supported medical units in the COMMZ. An expanded maintenance float of designated items will be maintained at this level. The float program for medical items is managed as the Medical Standby Equipment Program (MEDSEP).

b. Optical Fabrication support will be found throughout the theater. Division level support will be limited to fabrication of semifinished prescription single-vision lenses and spectacle repair services to all assigned or attached units. Optical fabrication requirements beyond the capability of the Division will be provided by the Corps/COMMZ MEDSOM Battalions on an area basis. The Corps MEDSOM will provide single-vision fabrication and spectacle frame repair. COMMZ MEDSOM Battalions will provide single and multivision spectacle fabrication, lens generation, and spectacle frame repair to the COMMZ on an area basis and backup to the Corps.

Section III. CONUS

17-5. Organization and Functions

a. Medical materiel (class VIII) is a Defense Logistics Agency (DLA) managed commodity. The Department of Defense (DOD) manages its wholesale system through DLA, under the policy guidance of the

Assistant Secretary of Defense (Manpower, Installations, and Logistics) (ASD (MI&L)). All depot stocks of medical materiel in CONUS, except those administratively segregated stocks which belong to the in-

dividual military services, are owned, managed, and financed by DLA. The medical commodity does differ from other common items of supply managed by DLA in that the Defense Medical Standardization Board (DMSB) is the sole activity empowered to add items to, delete items from, and modify items in the medical materiel section of the Federal Supply Catalog. The DMSB is composed of TSGs of the Army, Navy, and Air Force or their designated representatives.

b. The majority of medical materiel is supplied to the Army by DPSC which is responsible for wholesale support and management of inventories at all wholesale distribution activities where medical materiel is stored. DPSC also procures nonstandard medical materiel for the Army and Air Force overseas. AMEDD activities submit requisitions to DPSC and receive supplies from DLA depots or DPSC contractors. Although DPSC has the responsibility for procurement of wholesale stocks of medical materiel, Army command surgeons and hospital commanders are authorized to locally procure commercial items required in support of patient care and treatment. In the event of an emergency, they may also locally procure any standard medical item required immediately to save life or prevent suffering, when it is impractical to follow normal supply procedures.

c. TSG has Army Staff responsibility for planning, directing, and supervising health services for the Army, including medical materiel. Operating under basic Department of the Army (DA) logistics policies, TSG is responsible for the Army-wide management of medical materiel. In furtherance of this policy, the surgeon at each command echelon is responsible for the implementation, coordination, and direction of DA medical materiel programs. The USAMMA, a field operating agency of TSG, is the Service Item Control Center (SICC) for medical materiel and the AMEDD medical materiel program manager.

d. The organizational structure and operating functions for managing medical materiel at MEDDACs and medical centers is similar. At the installation level, medical materiel is managed by an Installation Medical Supply Activity (IMSA) operated by the MEDDAC or medical center. The Logistics Division of the hospital is the organizational element responsible for providing installation level medical materiel and medical maintenance support to the health service activities of the hospital, installation, and satellite activities. The mission and general functions of a hospital Logistics Division are to compute requirements; acquire, store, account for, and distribute supplies and equipment; plan, prepare, and maintain budget and financial inventory management programs for supplies and services provided to include management of the Medical

portion of the installation stock fund; direct the quality control program; and provide biomedical equipment maintenance support. In addition, this division provides for, or arranges for, the procurement of logistical services including communications, laundry, house-keeping, movement of personnel and materiel, and when authorized, optical fabrication.

17-6. Medical Material Acquisition Process

Medical Materiel Acquisition Process (AR 40-60). The policies and procedures set forth in chapters 6 and 7 of AR 40-60 are used by the AMEDD. TSG has overall responsibility for research, development, test, and evaluation (RDTE) and acquisition of medical materiel and related items. U.S. Army Medical Research and Development Command is subdelegated responsibility as materiel developer and maintains the technological base for the AMEDD. Developmental tests are conducted by U.S. Army Medical Bioengineering and Development Laboratory. The Academy of Health Sciences (Health Services Command) as combat developer is responsible for medical combat development activities and training development activities. The AMEDD board located at the Academy of Health Sciences is responsible for operational testing. USAMMA serves as mission assignee agency for acquisition of nondevelopment items and medical assemblages. USAMMA further serves as logistician and readiness coordinator in support of the overall acquisition process.

17-7. References

a. Army Regulation (AR)

10-71	U.S. Army Medical Materiel Agency
40-60	Policies and Procedures for the Acquisition of Medical Materiel
40-61	Medical Logistics Policies and Procedures
40-65	Review Procedures for High Cost Medical Equipment
310-49	The Army Authorization Documents System
710-1	Centralized Inventory Management of the Army Supply System
710-2	Supply Policy Below the Wholesale Level
750-1	Army Materiel Maintenance Concepts and Policies

b. Field Manuals (FM)

8-10	Health Service Support in a Theater of Operations
8-15	Medical Support in Divisions, Separate Brigades, and the Armored Cavalry Regiment
8-20 (test)	Health Service Support in the Combat Zone

- 8-21 Health Services Support in a Com-
munications Zone
- 8-55 Planning for Health Service Support
- 701-58 Planning Logistics Support for Mili-
tary Operations
- c. Common Table of Allowances (CTA)*
- 8-100 Army Medical Department Expend-
able/Durable Items
- d. Supply Bulletins (SBs)*
- 8-75 Series Army Medical Department
Supply Information
- e. Technical Bulletins (TBs)*
- 740-10 Appendix M Quality Control Depot
Serviceability Standards — Medi-
cal Supplies

CHAPTER 18

AUTOMATED LOGISTICS MANAGEMENT INFORMATION SYSTEMS

Section I. INTRODUCTION

18-1. General

The use of automated techniques in the field of logistics has become increasingly prevalent as the Army has sought new and better ways of managing the vast materiel resources for which it is responsible. The power of the computer has made possible the development of management informa-

tion systems which are capable of providing timely and pertinent information for logistics managers at all levels. The capability of these systems to store and process large amounts of data, handle routine decisions, and identify critical decision paths for management action makes them a tremendous aid for planning and controlling logistics operations.

Section II. THE STANDARD ARMY LOGISTICS SYSTEM

18-2. A Standard Army Logistics System

The standardization of functional systems at each echelon of management, Army-wide, is a major objective. The functional management structure at each level of the system will provide for weapon systems and commodity management to the required level of intensity. Such management will be included in SALS which features standard functions wherever performed. The key to the formulation of standard systems is the integration and development of interfaces between supply, maintenance, transportation, and other supporting functions. Budget and financial subsystems will be integrated in a modular fashion as they support management and operation of the system, with a plug-in/plug-out capability, as appropriate.

18-3. Army Materiel Command (AMC) System

a. Commodity Command Standard System (CCSS).

(1) CCSS is the total standard system that supports all functional areas of operation at the six major subordinate commands of AMC that have an Inventory Control Point mission. The functional areas include provisioning, cataloging, supply management, stock control, procurement, maintenance financial management, and international logistics. CCSS standardizes the wholesale logistic operation performed by AMC MSCs and automates the management of secondary items and repair parts.

(2) The system is capable of processing a high volume of transactions each day in multiple applications. Batch processing is applied and various transactions are processed to update, inquire or

place demands upon the system. A responsive information retrieval system using remote display terminals, provides the capability for users to inquire and obtain current updated information from the integrated data base files. Ongoing system enhancements are increasing the use of remote display terminals as "decision/entry" devices to allow data modification and correction, providing rapid logistic data handling while significantly reducing printed outputs.

b. U.S. Army Security Assistance Center Centralized Integrated System for International Logistics (CISIL). CISIL is an integrated ADP system designed to operate on a computer system in support of the Security Assistance Program (SAP). The system is designed to—

(1) Provide SAP managers a central data base facilitating the supply of materiel and services to foreign customers.

(2) Afford a system for financial control of SAPS and interface with Security Assistance Accounting Center (SAAC) in the accomplishment of customer billing and collection.

(3) Produce Grant Aid (GA), Foreign Military Sales (FMS) and Supply Support Arrangements (SSA), and (SAP) management reports for the Department of Defense (DOD), DA, AMC, U.S. Army Security Assistance Center (USASAC), and other Government agencies.

c. Depot systems.

(1) The total AMC depot complex is responsible for the receipt, delivery, storage, inventory, depot overhaul/repair of equipment managed by AMC national inventory control points (NICPs) and selected items of other Government activities. The standardization of depot operating systems supporting these functions is an integral part of the AMC Five-Year ADP Program. Major AMC

depots are currently operating standard ADP equipment (ADPE) using standard programs and procedures. This major standardization effort was originally referred to as "Project SPEEDEX" (Systemwide Project for Electronic Equipment at Depots-Extended), but was later renamed the Standard Depot System (SDS).

(2) SDS provides increased ADPE capability and permits total standardization. This system also provides the capability for total use of remote computer input/output devices located in the same depot or linking one depot with another. SDS provides the capabilities to accelerate processing of high-priority materiel release orders (MRO) by the use of remote devices such as visual terminals and readers, card punches, and printers located in functional areas. The remaining primary depot operations included in the SDS hardcore or follow-on systems are financial management, installation management, quality assurance, maintenance production planning and control, civilian personnel, and manpower management systems.

d. AMC Installation Standard Systems.

(1) *AMC Installation Supply System (AMCISS)* is the AMC standard installation logistic system below the wholesale level.

(2) *Installation Equipment Management System (IEMS)* is the standard AMC stand-alone property book/equipment management system. IEMS has the capability to interface with AMCISS.

(3) *Automated Self-Service Supply Center (ASSSC)* is a stand-alone, bar coded, checkout system. ASSSC interfaces with the standard AMC installation supply systems.

18-4. Other Multicommand Systems

a. The Combat Service Support System (CS3) is the standard ADP system used in all of the Army's 16 divisions. CS3 was designed to enhance the effectiveness of combat service support to the Army divisions by improving logistics responsiveness, materiel readiness, property accountability, and personnel management. This system provides the commanders with accurate data on available resources with which to support operational decisions. Additionally, much of the required data for vertical reporting to higher headquarters are provided. The system consists of a computer. CS3 provides the division with automated processing to support the division supply, maintenance, and personnel functions.

(1) *Maintenance.* The CS3 Maintenance Reporting and Management (MRM) system is a workload accounting system for use in the intermediate DS/GS production control office at the shop level,

in the maintenance battalion materiel office, and Division and Corps Support Command (COSCOM) Materiel Management Centers, depending upon table of organization and equipment (TOE) series. MRM has been designed to assist the maintenance manager by recording and accounting for data on maintenance requests. Through an interface with AMC major subordinate commands, it provides work order and repair parts history to AMC for measurement of equipment performance.

(2) *Personnel.* The Standard Installation/Division Personnel System (SIDPERS) provides for the personnel management and administration functions of the division.

(a) *Major functions.* SIDPERS has been designed to perform the major functions of strength accounting, organization and personnel record-keeping, interface system reporting, and management reporting.

(b) *Interface Reporting.* SIDPERS is designed to interface with the Joint Uniform Military Pay System (JUMPS), the Trainee Accounting and Management System (TAMS), and the Centralized Assignment Procedure III (CAP-III). It is designed to report directly to HQDA without the intervening processing performed by the Continental Army and Major Oversea Command System (CARMOCS).

(3) *Supply.* The DS4 is an Army-wide multi-command computer system designed to automate stock control and provide additional asset management capability at the divisional and nondivisional direct support unit (DSU) level and at selected general support unit (GSU) sites. DS4 operates in the divisional and nondivisional environment. Divisional area DS4 provides automated stock control for multiple DSUs, and replaces DLOGS class IX functions. Nondivisional area DS4 replaces DSU/GSU systems and provides automated stock accounting for a single DSU/GSU. DS4 division and nondivisional supply logic, input specifications, and reporting formats are identical. The DS5 divisional and nondivisional software will run on the decentralized automated supply system (DAS3) hardware.

(a) *Divisional.* Divisions will operate using a centralized stock control element located at the division materiel management center (DMMC). This element, using DS4 can manage stocks in up to 10 DS units. This organizational structure reflects the "umbrella concept" of support employed by the maintenance battalion DSUs within the division, where main DSUs are designated to carry backup stocks for forward support DSUs. Supply transactions will be accumulated on a daily basis and batch processed on the division computer

located at the division data center (DDC). It should be noted that the processing of a daily cycle is only an objective and not considered a mandatory requirement. Batch processing within the divisional environment is necessary since the division computer is not dedicated to the supply function; but also supports the processing of maintenance, personnel, and financial systems.

(b) *Nondivisional*. Each supply support DSU in the nondivisional environment is a stand alone

supply activity. It has an organic Stock Control Section (SCS) which manages the DSU stocks using the DS4 system operating on the DSUs organic mini-computer, the Decentralized Automated Service Support System (DAS3). The mini-computer is dedicated to the DSU supply mission thus making possible concurrent posting of transactions in addition to batch processing.

b. A Combat Service Support Automation/Communications Transition Plan was developed by the U.S.

Army Logistics Center (assisted by the U.S. Army Signal School, Soldier Support Center, and Academy of Health Sciences) and distributed in September 1981. This plan presents a method of eventually replacing existing systems in theater of operations CSS units with systems operable on two types of hardware—the DAS3 and Tactical Army Combat Service Support Computer System (TACCS). It offers diversified capabilities with different sizes/models of computers.

c. The Base Operating System (BASOPS) is the installation operating system of the Army Management Information System (AMIS). BASOPS is an operational system incorporating automated and manual procedures and its major feature is a standard data base to provide management information for all elements of the using organization. The BASOPS subsystems will include SIDPERS, the Standard Finance System (STANFINS), and the Standard Army Intermediate Level Supply (SAILS) Subsystem. The scope of BASOPS will be expanded until the full spectrum of installation management support is achieved.

d. The Standard Property Book System (SPBS) is a stand-alone system designed to function at installation, corps, division, separate brigade, or armored cavalry regiment level. The system operates through two basic applications, centralized/decentralized property book and asset visibility applications. SPBS contains several features that represent an enhancement over the DLOGS Property Book, not the least of which is its adaptation to both the divisional and nondivisional environment. It has a direct inquiry capability by line item number (LIN) and/or national stock number (NSN), can delete records in daily cycles, and can produce updated hand receipts on call. Finally, it has a direct interface with SAILS, DS4, Continuing Balance System—Expanded (CBS-X), and other automated logistics support systems.

e. The Standard Army Intermediate Level Supply (SAILS) subsystem is concerned with intermediate level logistics; i.e., the system below the wholesale level and above the DS level. Currently, standardization of the wholesale level logistics system is accomplished by AMC through CCSS and SDS. DS level logistics is being standardized through the implementation of DS4. SAILS is the first step at standardizing the intermediate level. See paragraphs 18-6 through 18-7 for a more detailed description of SAILS.

f. The Standard Army Ammunition System (SAAS) is being designed for the management of class V conventional ammunition to include guided missiles and large rockets. The SAAS level 1 system is operational at the theater level in USAREUR and WESTPAC and provides theater management information and input through the Worldwide Ammunition Reporting

System to the wholesale and national levels. The SAAS level 3 system is to provide class V management information to the corps materiel management center (MMC) and other stock control activities. The SAAS level 4 system is to provide a management information system to the ammunition supply point and other class V storage locations.

g. The Standard Army Maintenance System (SAMS) is the DA logistics management information system encompassing the function of materiel maintenance which will provide for uniformity and standardization within the three levels of maintenance management; e.g., national (HQDA); wholesale (AMC); and retail (operator/crew, organizational, intermediate DS and GS operations, and the headquarters supervising their operations). The overall objective of SAMS is to establish a standard uniform maintenance management and information system in support of the materiel maintenance operations of the field commander, the materiel developer, and the national authorities. The primary source of information concerning materiel operational performance and maintenance operations performance is at the intermediate category of maintenance. Recognizing this, SAMS establishes its primary data bank and its most judicious data gathering and manipulations at this level. Subsequently, SAMS integrates all outputs vertically and horizontally to meet the information requirements of the Army in the field, wholesale, and national levels of the logistics system.

h. The Integrated Transportation Management Information System (ITMIS) envisions the development of a standard transportation system, vertically oriented from the national level through user level. ITMIS will be supported by a number of horizontal operating systems covering the functional areas involved in the transportation and control of movement (including shipment unit intransit visibility) of both people and things, retrograde as well as forward, worldwide. The operating systems will be applicable to all levels from operating units in the field to the national level and will interface with supply and financial systems at each level. Three computer management systems, the Terms on Line System (TOLS), the Department of the Army Standard Part System—Enhanced (DASPS-E) and the Department of the Army Movement Management System (DAMMS), are designed to manage and control intertheater cargo shipments from the CONUS export terminal through the oversea terminal to the consignee. The TOLS and DASPS-E are used for ocean cargo. The U.S. Air Force Consolidated Aerial Port System (CAPS) provides for the control and management of intertheater air shipments. The DAMMS will interface with TOLS,

DASPS-E, and CAPS, providing the theater commander the capability to manage all cargo entering a theater, by either air or ocean modes, and controlling the onward movement from the terminal to the consignee/destination. TOLS, DASPS-E, and DAMMS basic data requirements are in consonance with the Military Standard Transportation and Movement Procedures (MILSTAMP).

(1) Terms on Line is a system designed to provide management/control of export cargo from CONUS DOD shippers through the port. It is an operational system, preparing documentation such as manifests, inventories, and hatch lists which improves the visibility of intransit cargo and the ability of the port to control and trace that cargo. The system is used exclusively by the Military Traffic Management Command (MTMC) at its CONUS terminals.

(2) The DA Standard Port System—Enhanced (SPSE) is a standard computer-oriented system designed to satisfy cargo accounting documentation and related functions at the oversea terminal. Interfacing with the TOL system via AUTODIN, it provides the means for managing and maintaining accountability of the cargo through the port to the destination using MILSTAMP documentation. It is a deployable system fully capable of handling wartime requirements of port facilities in a theater of operations.

(3) The DA Movement Management System (MMS) is an operating and management information system developed to enhance planning, programing, and control of transportation resources in a theater of operations. It will provide current, readily assessable information on the status of movements, cost of operations, and effectiveness of performance in a theater. The system consists of four modules; cargo movements, movements planning, mode management, and performance management. The modular design provides the theater commander flexibility in selecting and using the modules or parts of the system which

best meets the commander's requirements. It is a fully deployable system capable of handling the wartime movements in a theater.

j. The Defense Integrated Data System (DIDS) is being developed in order to establish a central data bank for the generation, receipt, transmission, validation, storage, control, dissemination, and disposition of logistics data. The volume and range of data maintained at all levels will be greatly reduced in favor of direct interface of Army systems with the DIDS data bank. Thus, there will be a requirement to revise Army systems and procedures to comply with the DIDS concept of operation.

k. The Asset Control System (ACS) provides an automated data base for use at the major command level for reportable item control code (RICC) 1 and 2 items. Onhand information, obtained from the CBS-X is combined with authorization data from Vertical—The Army's Authorization System (VTAADS) on a monthly basis. Various management reports are produced routinely at some of the major Army commands (MACOM) whereas others use locally developed programs to format report data. The standard system processes as well.

18-5. The Integrated Facilities System (IFS)

IFS is a multicommand ADP system designed to provide information to be used for the management of real property resources, and to assist managers at all levels in the decisionmaking process for the operation and maintenance of facilities. IFS furnishes the Army managers with a guidance and reporting system to support the planning, programing, budgeting, execution, and review cycle of real property management and new construction. The system provides for the collection of direct costs for the operation and maintenance of facilities.

Section III. THE STANDARD ARMY INTERMEDIATE LEVEL SUPPLY (SAILS) SUBSYSTEM

18-6. General

a. SAILS is a standard intermediate level supply system using the Vertical Installation Automation Baseline (VIABLE), an information management system that responds quickly to U.S. Army needs by linking large regional data centers (RDCs) to individual military installations. RDCs handle large volumes of data processing from a centralized location. The five regional RDCs are located near Fort Belvoir, VA, Fort McPherson, GA, Fort Hood, TX, Fort Knox, KY, and Fort Ord, CA. Equipped with multiple large-scale

computer processing units, or mainframes, each RDC serves approximately nine distributed processing centers (DCPs) located on military installations and at numerous off-post satellite installations. SAILS personnel enter data on terminals in their office. The information goes through the DPC's communication processor, which is the link to the RDC.

b. SAILS is designed to satisfy Army-wide supply operations requirements for the intermediate support

level between wholesale support level systems at AMC, the Defense Logistics Agency (DLA), and the General Services Administration (GSA); and the direct support level, the Class I installations and the Corps Support Commands (SUPCOMs), formerly COSCOMs.

18-7. Operational Concept

a. SAILS is designed to support supply and related financial management operations for supply classes H, packaged III, IV, VII, VIII, and IX. The concept for development of SAILS involves modularization of the various supply management and support functions with plug-in/plug-out applications which can be tailored to fulfill the unique logistics organization/operations, found between Army major commands, without system redesign and/or reprogramming.

b. SAILS is designed to group supply operations functions into general categories as follows:

(1) Level A (Supply and Finance Modules) is supply management and related financial management. This includes supply control, requirements computation, stock fund reporting, stockage list management, asset reporting, catalog data, and stock record support.

(2) Level B (Storage Operations Module) is supply support operations which include stock locator maintenance, processing materiel receipts, storage of materiel, shipment, and inventory requirements.

c. SAILS basic processes have been designed as an integrated processing system, wherein correctly coded, valid transactions can be processed throughout the various functions without referral, recording, or reentry unless manager-entered parameters specify otherwise. The Basic Supply Cycle is the hub of SAILS with a high degree of interrelationship to all processes. The Basic Supply Cycle includes processes which are a part of storage and financial operations. At COS-

COM, the COSCOM Buffer is included in order to reformat COSCOM transactions for stock fund processing.

18-8. References

a. *Army Regulations (AR).*

- 10-9 United States Army Computer Systems Command
- 10-11 United States Army Materiel Development and Readiness Command
- 12-8 Foreign Military Sales Operation's/Procedures.
- 13-1 Army Automation Management
- 13-7 Automatic Data Processing Management Review Program
- 70-1 Systems Acquisition Policy and Procedure
- 70-17 System/Program/Project/Product Management
- 700-9 Policies of the Army Logistics System
- 700-127 Integrated Logistics Support
- 750-1 Army Material Maintenance Concepts and Policies
- 710-2 Supply Policy Below the Wholesale Level

b. *Department of the Army Pamphlets (DA Pam).*

- 11-25 Life Cycle System Management Model for Army Systems

c. *Technical Bulletins (TB).*

- 18-112 Training Management for ADP Systems

d. *Technical Manuals (TM).*

- 38-L03 series
- 38-L06 series
- 38-L09 series
- 38-L22 series
- 38-L32 series

INDEX

	<i>Paragraph</i>	<i>Page</i>		<i>Paragraph</i>	<i>Page</i>
Academy of Health Sciences	17-6	17-4	System	4-9f	4-7
Acceleration Planning	8-1b(1)	8-1	Planning	4-9	4-6
Accounting			Planning Policy Guidance	9-15b	9-5
Accrual	4-24b	4-14	Planning, Programing, and Budgeting		
Appropriation and Fund	4-27b	4-15	System	4-9b	4-6
Army Management	4-24	4-14	Principles of Logistics	1-15	1-9
Cost	4-27e	4-16	Programing	4-11	4-8
Decentralized	4-26	4-15	Secretary of	2-9a	2-6
Expense	4-27c	4-15	Stationing and Installations Plan	14-2b	14-1
Financial Inventory	4-27d	4-15	Stock Fund	4-17	4-11
Integrated	4-25	4-15	Strategic Appraisal	4-9c	4-7
Real Property	4-27f	4-16	Systems Acquisition Review Council	6-13b(2)	6-4
Acquisition			Asset Control System	18-4k	18-4
Authority and Responsibility	7-5	7-3	Assistant Secretary of Defense		
Defined	1-9e(2)	1-5	Comptroller	2-3b(3)	2-1
Direction	9-21	9-7	Health Affairs	2-3b(4)	2-2
Laws and Regulations	7-4	7-2	International Security	2-3b(1)	2-1
Objective	9-19b	9-7	Manpower, Installations, and		
Planning	7-7	7-3	Logistics	2-3b(5)	2-2
Policy	6-1	3-1	Program Analysis and Evaluation	2-3b(6)	2-2
Process	7-2	7-1	Automated Calibration System	11-17b	11-6
Written Plan	7-7c	7-3	Automated System for Transportation		
	7-7d	7-3	Data	12-6c(1)	12-5
Administrative Contracting Officer	7-12c	7-6	Automatic Reimbursement Authority	4-22d	4-14
ADP in Transportation Management	12-6c	12-5			
Advanced Development	6-11c	6-2	Backlog of Maintenance and Repair	14-8d(4)	14-3
Airline of Communication	10-9a	10-4	Base Operating Information System	18-4c	18-3
	10-18d	10-8	Base Support	7-8a(1)	7-1
	10-19e	10-9	Basic		
	10-19f	10-9	Daily Food Allowance	18-2e	18-1
Allied Support	2-5	2-2	Load	10-18d	10-6
Ammunition			Research	6-11a	6-2
Basic Load	10-13d	10-6	Supply Cycle	18-7c	18-5
Conventional	10-13b	10-6	Budget		
	10-13d	10-6	Appropriations and Program Elements	4-5	4-3
	10-13e	10-6	Execution	4-14	4-10
Distribution of	10-13	10-6	Formulation	4-13	4-9
Special	10-13b	10-6	Structure	4-12	4-8
	10-13f	10-6			
Annual			Care of Supplies in Storage	10-7g	10-4
Food Plan	13-2d	13-1	Cataloging Direction	9-18	9-6
Work Plan	14-8d(3)	14-3	Categories of Research, Development,		
Appropriation and Fund Accounting	4-27b	4-15	Test, and Evaluation	6-11	6-2
Area-Oriented Depots	10-19b	10-8	Central Issue Facility	18-5	18-2
Area Support	7-3a(2)	7-1	Centralized Integrated System for		
Army in the Field Materiel Maintenance	11-13	11-3	International Logistics	18-3b	18-1
Army			Channels of Distribution	10-4	10-2
Acquisition Objective	9-19b	9-7	Chief of Staff of the Army	2-9a	2-6
Chief of Staff	2-9a	2-6	Civil Defense Support	5-18	5-17
Concepts of Distribution	10-5	10-2	Civil Disturbances Control Operations		
Defense Acquisition Regulation			Support	5-20	5-18
Supplement	7-1c	7-1	Clothing		
Food Service Program	13-2	13-1	Exchange and Bath	13-7	13-3
Force Program	4-9e	4-7	Initial Issue Point	13-4	13-2
Industrial Fund	4-19	4-12	Sales Store	13-6	13-2
Logistics System	18-2	18-1	Collection and Classification Companies	16-6c	16-3
Management Fund	4-21b	4-13	Combat Service Support System	18-4a	18-2
Management Accounting	4-24	4-15	Command Operating Budget	4-11d	4-8
Master Plan	9-16b	9-5	Commissary Stores	13-3	13-2
Medical Department	17-1b	17-1	Commodity Command Standard System	18-3a	18-1
Mobilization and Operations Planning			Component Command	2-5i	2-3

	<i>Paragraph</i>	<i>Page</i>		<i>Paragraph</i>	<i>Page</i>
Compression Planning	8-1b(3)	8-1	Personnel Support Center	10-11a	10-5
Comptroller of the Army	4-13a	4-9	Programming System	4-10	4-7
Concept of Need	6-2	6-1	Property Disposal Service	16-3d	16-2
Concurrent Return Program	13-9c	13-3	Secretary of	2-3b	2-1
Configuration Management	8-8	8-4	Security Assistance Agency	15-3c(2)	15-2
Containerization	12-6a	12-4	Systems Acquisition Review Council ...	6-13b(1)	6-4
Container Oriented Distribution System	12-6b	12-5	Demand		
Controlled Supply Rate	10-13d	10-6	Defined	9-9	9-3
Consolidated Guidance	9-15b	9-5	Patterns	9-9	9-3
Consolidation and Containerization Points ...	10-19d	10-9	Forecasting Techniques	9-10	9-3
	10-19e	10-9	Department of the Army Master Priority		
Consumer	1-13a	1-8	List	9-22c	9-8
Construction	7-3a(8)	7-2	Department of the Army Planning Role	5-7	5-11
Consumer Funds	4-20	4-13	Department of Defense Programing		
Contract			System	4-10	4-7
Administration	7-12	7-6	Depot		
Administration Office	7-12b	7-6	Maintenance	1-9e	1-5
	7-12c	7-6	(4)(b)g		
Administrative Contracting Officer	7-12c	7-6	11-11d	11-3	
Cost Responsibility	7-11c	7-5	11-14c	11-5	
Defined	7-11a	7-5	Maintenance Work Requirements	11-9	11-3
Determination of Type	7-11d	7-5	System Command	5-8d	5-13
Elements	7-11a	7-5	9-19	9-6	
Funding	7-6	7-3	Transportation Officers	12-5e	12-4
Initiation of Process	7-8	7-3	Development Testing	6-16b	6-4
Maintenance	11-15	11-5	Direct		
Principal Contracting Officer	7-12a	7-6	Obligational Authority	4-22b	4-13
Contracting Officer	7-5d	7-3	Support Maintenance	1-9e	1-5
Contractor-Owned and Contractor-Operated			(4)(a)l		
Facilities	8-3c	8-2	11-11b	11-3	
Contractual Instruments	7-11	7-5	11-13b	11-4	
Conventional Ammunition	10-13b	10-6	Support System	10-9a	10-4
	10-13d	10-6	10-18	10-8	
	10-13e	10-6	10-19	10-8	
Conversion Planning	8-1b(2)	8-1	Support Unit Standard Supply System	18-4b	18-2
Corps Support Command	2-9c(2)	2-6	Director of Facilities Engineering	14-1c	14-1
Costs			Disaster Relief Support	5-19	5-17
Accounting	4-27e	4-16	Disposal	1-9e(5)	1-5
Control of	8-7	8-3	9-24	9-9	
Holding	9-7a	9-2	Distribution		
	9-7b	9-2	Army Concepts of	10-5	10-2
Ordering	9-7a	9-2	Channels of	10-3a	10-1
Responsibility for	7-11c	7-5	Defined	1-9e(3)	1-5
Covered Storage	10-7c(1)	10-3	Direction	9-22	9-8
Crisis Action System	5-4 f(4)	5-4	Materiel	10-9	10-4
	5-4n	5-9	Objective	10-2a	10-1
Current Death Program	13-9a	13-3	of Ammunition	10-13	10-6
Defense			of Bulk Petroleum	10-12	10-5
Acquisition Regulation	7-1c	7-1	of General Supplies	10-10	10-4
	7-4e	7-2	of Major End Items	10-15	10-7
Automatic Addressing System	10-19c	10-8	of Medical Materiel and Repair Parts ...	10-16	10-7
	10-20h	10-10	17-3	17-2	
Contract Administration Service	7-12d	7-6	of Nonmilitary Support Materiel	10-17	10-7
Department of	2-3a	2-1	of Personal Support Items	10-14	10-7
Fuel Supply Center	10-12c	10-5	of Subsistence	10-11	10-5
General Supply Center	10-12c	10-5	Pipeline	10-6a	10-3
Industrial Plant Equipment Center	8-1c	8-1	Systems Concept of	10-4	10-2
Integrated Data System	18-4j	18-4	Division		
Logistics Agency	2-7e	2-5	Logistics System	18-4a	18-2
Logistics Agency Plan Support	5-11	5-14	Medical Supply Officer	17-2e	17-2
Logistics Agency Stock Fund	4-18	4-12	Support Command	2-9c(3)	2-7
Medical Materiel Board	17-5a	17-3	Economic Order Quantity	9-12	9-4
Personal Property Disposal Program ...	16-2a	16-1			

	<i>Paragraph</i>	<i>Page</i>		<i>Paragraph</i>	<i>Page</i>
Engineering Development	6-11d	6-2	Graves Registration Service	13-9	13-3
Equipment Publications	11-8	11-2	Head of the Contracting Activity	7-5c	7-3
Excess Declaration Reporting	16-4	16-2	Health Services	17-1a	17-1
in CONUS	16-5	16-2	Holding Costs	9-7a	9-2
in Oversea Theaters	16-6	16-2		9-7b	9-2
Excess Property			Indirect Maintenance Support	1-9e	1-5
Declaration and Reporting	16-4	16-2		(4)(a)2	
	16-5	16-2	Industrial		
	16-6	16-2	Preparedness Measures	8-1b(6)	8-1
Defined	16-1b	16-1	Preparedness Planning	8-1b	8-2
Screening	16-7	16-3	Support	7-3a(3)	7-1
Transfer Among Military and Civilian			Installation		
Federal Agencies	16-8	16-3	Defined	2-9c(4)	2-7
Transfer to Foreign Governments	16-9	16-4	Funding	4-22	4-13
Expense Accounting	4-27c	4-15	Logistics	2-8a	2-5
Exploratory Development	6-11b	6-2	Logistics Maintenance Management		
			Information Systems	11-17	11-6
Facilities Maintenance	1-9e	1-5	Master Plan	14-2a	14-1
	(4)(c)			14-3b	14-1
Facilities Requirements	3-5	3-4	Medical Supply Activity	17-5d	17-4
Federal Supply Service	9-3b	9-1	Transportation Officers	12-5e	12-4
Financial Inventory Accounting	4-27d	4-15	Integrated		
Five-Year Defense Plan	4-6b	4-5	Accounting	4-25	4-15
	9-15b	9-5	Facilities System	14-6	14-2
Fixed Safety Levels	9-11b	9-4		18-5	18-4
Food Advisor	13-2f(2)	13-1	Logistics Support	11-1	11-1
	13-2g	13-1	Logistics Support Management Model	6-14	6-4
Force Mobilization Planning	5-15	5-15	Transportation Management		
Force Requirements Generator	5-4k	5-6	Information System	18-4h	18-3
	(2)(b)2		Intermediate Maintenance	1-9e	1-5
Foreign Military Sales	15-2b	15-1		(4)(b)2	
	(3)(c)		International Military Education and		
Formal Advertising			Training	15-2b	15-1
Conditions for	7-9e	7-4	Inventory		
Defined	7-9b	7-4	and Fiscal Processes	9-5	9-2
Purposes	7-9c	7-4	Control Effectiveness Program	9-28a	9-10
Fund			Cost of	9-7a	9-2
Army Industrial	4-19	4-12	Forecasting Demand	9-10	9-3
Army Management	4-21b	4-13	Management at Installations in		
Army Stock	4-17	4-11	CONUS	9-26	9-9
Consumer	4-20	4-13	Management Objective	9-2	9-1
Defense Logistics Agency Stock	4-18	4-12	Management Overseas	9-27	9-10
Installation	4-22	4-13	Property Accountability	9-28	9-10
Management	4-21a	4-13	Purposes of	9-6	9-2
Nonappropriated	4-23	4-14	Selective Management of	9-8	9-3
Revolving	4-16c	4-11	Invitation for Bids	7-8d	7-4
Working Capital	4-16	4-11	Joint		
	9-5c	9-2	Chiefs of Staff	2-4	2-2
Funded Reimbursement Authority	4-22c	4-13	Chiefs of Staff Responsibilities	5-3e	5-2
General			Long-Range Strategic Appraisal	4-8b	4-6
Accounting Office	2-7c	2-5	Operations Planning System	5-4	5-3
Materiel and Petroleum Activity	10-12c	10-5	Petroleum Office	10-12d	10-5
Services Administration	2-7b	2-4	Planning Process	5-4e	5-3
Services Administration Plan Support	5-12	5-14		5-4h	5-4
Support Maintenance	11-11c	11-3	Program Assessment Memorandum	4-8e	4-6
	11-13a	11-3		9-15b	9-5
Government			Reporting Structure	5-4g(2)	5-4
Contract Law	7-4a	7-2	Strategic Capabilities Plan	4-8d	4-6
-Furnished Facilities	8-2	8-1		5-4i	5-4
-Owned and Contractor-Operated	8-3b	8-2	Strategic Planning Document	4-8c	4-6
Facilities	8-4	8-2	Strategic Planning System	4-8	4-6
-Owned and Government-Operated	8-3a	8-1		5-4d	5-3
Facilities	8-4	8-2			

	<i>Paragraph</i>	<i>Page</i>		<i>Paragraph</i>	<i>Page</i>
Transportation Board	12-3c	12-2	Utilization and Disposal	9-24	9-9
Laundry and Drycleaning	13-8	13-3	Utilization Program (DOD)	16-1	16-1
Letter				16-2	16-1
of Agreement	6-6	6-1	Medical	16-3	16-1
Requirement	6-8	6-2	Command	17-2a	17-1
Life-Cycle System Management Model	6-12	6-4	Logistics Center	17-2a	17-1
Location Survey	9-28a(4)	9-10	Logistics Organization and Functions ...	17-2	17-1
Logistics			Logistics System	17-1b	17-1
Control Activity	12-5d	12-4	Maintenance and Optical Support	17-4	17-3
Defined	1-6	1-2	Materiel and Distribution	17-3	17-2
Environment	1-6c	1-2	Materiel Development and		
Intelligence File	10-18e	10-8	Acquisition	17-6	17-4
	10-19c	10-8	Organization and Function in		
	12-5d	12-4	CONUS	17-5	17-3
Installation	2-8a	2-5	Supply, Optical, and Maintenance		
Joint Chiefs of Staff Guidance	1-14	1-8	Unit	17-2a	17-1
Mission	1-8	1-4		17-2b	17-1
Objective of	1-6d	1-2		17-4	17-3
Planning and Programing Guidance	5-3a	5-2	Supply Support Planning	5-9	5-13
Principles	1-15	1-9	Military		
Responsibilities for	2-9	2-6	Airlift Command	12-4d	12-3
Logistics System			Assistance Program	15-2	15-1
Analysis	1-11	1-6	Departments	2-6	2-4
Approach	1-9	1-4	Sealift Command	12-4c	12-3
Functional Structure	1-12	1-6	Supply and Transportation Evaluation		
Management of	1-10	1-5	Procedures	10-20d	10-10
Maintenance			Traffic Management Command	12-4b	12-2
Allocation Charts	11-12	11-3	Military Standard		
Army Wholesale Materiel	11-14	11-5	Billing System	10-20g	10-10
Categories	11-11	11-3	Contract Administration Procedures	10-20e	10-10
Defined	1-9e(4)	1-5	Logistics Systems	10-20	10-9
	11-3a	11-1	Petroleum System	10-20f	10-10
Engineering	11-5	11-1	Requisitioning and Issue Procedures	10-20a	10-9
	11-6	11-2	Transaction Reporting and Accounting		
	11-7	11-2	Procedures	10-20b	10-10
Information Requirements	11-16	11-5	Transportation and Movement		
Management	11-2	11-1	Procedures	10-20c	10-10
	11-4	11-1	Mission Element Need Statement	6-3	6-1
Operations Management	11-10	11-3	Mobilization Planning	5-16	5-16
Reliability-Centered	11-2d	11-1	Movements Management	12-15	12-11
Reporting and Management System	18-4a(1)	18-2		12-16	12-11
Major				12-17	12-11
Army Appropriations	4-12b	4-8		12-18	12-12
Force Programs	4-4b	4-3	Movement Requirements Generator	5-4k	5-6
Items	9-15a	9-5		(2)(b)3	
	9-16	9-5	National Inventory Control Points	9-17	9-6
	9-19	9-6	National Security		
Management			Council	2-2a	2-1
and Support	6-11e	6-2		2-2b	2-1
by Exception	9-19c	9-7		2-2c	2-1
Control Number	9-18b	9-6		5-1b	5-1
Funds	4-21a	4-13	Planning	4-7	4-6
of Information	3-8	3-6	Strategy	1-7a	1-2
Manpower Requirements	3-3	3-1	National Stock Number	9-18a	9-6
Master Menu	13-2d	13-1		9-18b	9-6
Materiel				9-18a	9-6
Acquisition Decision Process	6-13	6-4	NATO Stock Number		
Distribution	10-9	10-4	Negotiation		
Fielding	3-11	3-7	Defined	7-10a	7-4
Maintenance Management Objectives ...	11-2	11-1	Requirements for	7-10c	7-5
Requirements	3-4	3-2	Nonappropriated Funds	4-23	4-14

	<i>Paragraph</i>	<i>Page</i>		<i>Paragraph</i>	<i>Page</i>
Office			Maintenance Activities	14-7	14-2
of Management and Budget	2-7a	2-4	Maintenance Activities Management		
of the Secretary of the Army	2-9a	2-6	Program	14-8	14-3
of the Chief of Staff of the Army	2-9a	2-6	Program	14-1b	14-1
Open Storage	10-7c(2)	10-4	Program Development Execution	14-3	14-1
Operational			Program Planning	14-2	14-1
Readiness Analysis	4-11e	4-8	Reliability-Centered Maintenance	11-2d	11-1
Testing	6-16c	6-4	Reorder Point	9-27b	9-10
Ordering Costs	9-7a	9-2	Request for Proposals	7-3d	7-4
Order Quantity	9-12a	9-4	Required Operational Capability	6-7	6-2
Organizational Maintenance	1-9e	1-5	Required Supply Rate	10-13d	10-6
	(4)(b)1		Requirements Determination		
	11-11a	11-3	Defined	1-9e(1)	1-4
	11-13	11-3	Major Items	9-19	9-6
Overhaul/Rebuild Direction	9-23	9-8	Secondary Items	9-20	9-7
Packaging of Materiel	10-8	10-4	Requisitioning Objective	9-27b	9-10
Planned			Resale Commissary Stores	13-3	13-2
Resupply	10-5b	10-2	Research and Development	7-3a(6)	7-2
Supply	10-5a	10-2	Research, Development, Test and		
Planning and Programing Guidance			Evaluation	6-10	6-2
Memorandum	4-11e	4-8		6-11	6-2
Planning Emergency Support for Allies	5-14	5-15	Resource		
Planning, Programing, and Budgeting			Controls	8-9	8-4
System			Inputs	4-3	4-1
as a Closed Loop	4-6	4-5	Management Plan	14-8d(1)	14-3
Elements	4-2	4-1	Retention Level	9-24	9-9
Process Summarized	4-1c	4-1	Return of Remains Program	13-9d	13-3
Plans of Supported Unified and Specified			Revolving Fund	4-16c	4-11
Commands	5-5	5-10		4-16d	4-11
Prepackaging Modules of Supply	10-5f	10-3	Safety Levels	9-11	9-4
Pre-Positioning of Supplies and Equipment			Science and Technology Objective Guide	6-4	6-1
Principal Contracting Officer	7-12a	7-6	Scope and Magnitude of Army Acquisition		
Process Planning	8-5c	8-2	Secondary Items Determination	9-20	9-7
Procurement			Secretary of		
Appropriation, Army	9-5b	9-2	Defense	2-3b	2-1
	9-15	9-5		9-14	9-4
Request Order	9-16d	9-6		15-3c	15-2
Producer	1-13a	1-8	Defense Planning and Programing		
Production			Guidance Memorandum	5-3a	5-2
Controls	8-5	8-2	State	15-3b	15-2
Stoppage	8-5b	8-2	the Army	2-9a	2-6
Program				15-3d	15-2
Analysis Resource Review	4-11d	4-8	Security Assistance	15-1	15-1
and Budget Guidance	4-11d	4-8	Centralized Integrated System for		
Decision Memorandum	4-10d	4-7	International Logistics	18-3b	18-1
	9-15b	9-5	Legislation	15-2	15-1
Management Plan	6-9	6-2	Management	15-4	15-2
Objectives	4-3	4-1	Responsibilities	15-3	15-1
Objectives Memorandum	4-8e	4-6	Service Item Control Centers	9-3b	9-1
	4-10d	4-7	Special Ammunition	10-13b	10-6
	9-15b	9-5		10-13f	10-7
Project Management	6-15	6-4	Specified Command	2-5	2-2
Property Disposal Companies	16-6d	16-3	Standard		
Purchase Request	7-8a	7-3	Army Ammunition System	18-4f	18-3
	7-8b	7-4	Army Intermediate Level Supply	18-4e	18-3
			Subsystem	18-6	18-4
Quality Assurance	8-6	8-3		18-7	18-5
Real Estate Acquisition	14-4	14-2	Army Logistics System	18-2	18-1
Real Property			Army Maintenance System	11-17c	11-6
Accounting	4-27f	4-16		18-4g	18-3
Automation	14-6	14-2	Depot System	18-3c	18-1
Defined	14-1a	14-1	Installation/Division Personnel		
Disposal	14-5	14-2	System	18-4a(2)	18-2

	<i>Paragraph</i>	<i>Page</i>		<i>Paragraph</i>	<i>Page</i>
Property Book System	18-4d	18-3	Support Agency	13-3c	13-1
Storage	10-7	10-3	13-3b	13-2	
Subcontractor Planning	8-1b(4)	8-1	Total Army		
Supplier Planning	8-1b(5)	8-1	Analysis	4-11e	4-8
Supply Systems Support	7-3a(4)	7-1	Equipment Distribution Program	9-22c	9-8
Supporting Unified Command Planning			Logistics Readiness/Sustainability	4-11e	4-8
Role	5-6	5-10			
Support Maintenance Management System	11-17a	11-6	Unconstrained Requirements Report	14-8d(2)	14-3
Surgeon General	17-1b	17-1	Under Secretary of Defense		
	17-5c	17-4	Policy	2-3b(1)	2-1
Surplus Property	16-1b	16-1	Research and Engineering	2-3b(2)	2-1
			Unified Command	2-5	2-2
Test and Evaluation	6-16	6-4	Plan	5-3f	5-2
The Army Maintenance Management			Uniform Materiel Movement and Issue		
System	11-17a	11-6	Priority System	10-20i	10-10
Theater Army	2-9c	2-6	Unit Status and Identity Report	5-4g(4)	5-4
Theater Transportation Services	12-11	12-6	Unit Status Reporting	3-9	3-6
Throughput of Supplies	10-5c	10-2	United States Army		
Time-Phased Force and Deployment List ...	5-4k	5-6	Forces Command	2-9b(3)	2-6
	(2)(b)2		Health Services Command	2-9b(4)	2-6
Time-Phased Transportation Requirements			Materiel Command	2-9b(1)	2-6
List	5-4d	5-6	Materiel Development and Readiness		
	(2)(b)4		Command Planning Role	5-8	5-12
Transportation			Medical Materiel Agency	17-3b	17-2
ADP and Communications in			Medical Research and Development		
Management	12-6c	12-5	Command	17-6	17-4
DA Transportation Service			Security Assistance Center	15-3f	15-2
Organization	12-5	12-4	Training and Doctrine Command	2-9b(2)	2-6
DOD Transportation System	12-3	12-1	Unitization of Shipments	10-5d	10-2
Feasibility Estimator	5-4k	5-6			
	(2)(b)4		Variable Safety Level	9-11c	9-4
Management Agencies	12-3b	12-2			
Mode Operations	12-13	12-9	Weapon Systems Acquisition	7-3a(5)	7-1
Operating Agencies	12-4	12-2	Wholesale		
Operating Agencies Plan Support	5-13	5-14	Logistics	2-8b	2-5
Organizations Outside DOD	12-2	12-1	Materiel Maintenance	11-14	11-5
Requirements	3-6	3-5	Working Capital Funds	4-16	4-11
Services	7-3a(7)	7-2		9-5c	9-2
Terminal Operations	12-14	12-10	Worldwide Military Command and Control		
Troop			System	5-4g	5-4
Issue Subsistence Activity	13-2f	13-1			

By Order of the Secretary of the Army:

Official:

DONALD J. DELANDRO
Brigadier General, United States Army
The Adjutant General

JOHN A. WICKHAM, JR.
General, United States Army
Chief of Staff

Distribution:

Active Army, ARNG, USAR: To be distributed in accordance with DA Form 12-11A requirements for Logistics Management.

☆ U.S. GOVERNMENT PRINTING OFFICE : 1993-342-421 (81790)